

Joseph Lstiburek, Ph.D., P.Eng, ASHRAE Fellow

Building Science

Adventures In Building Science

presented by www.buildingscience.com



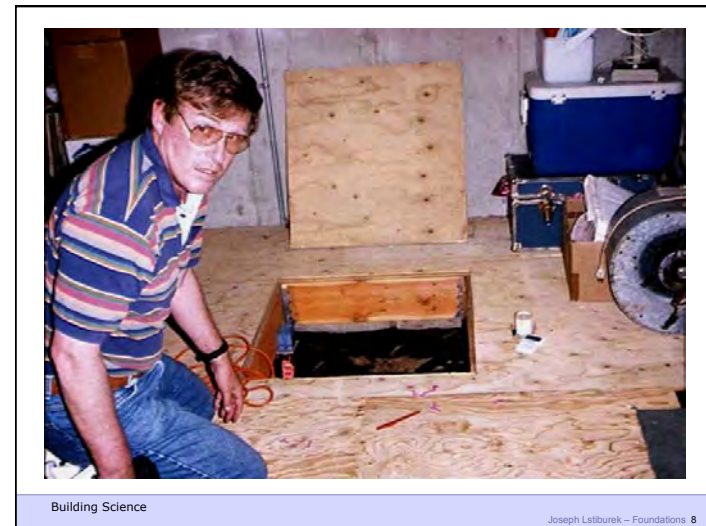
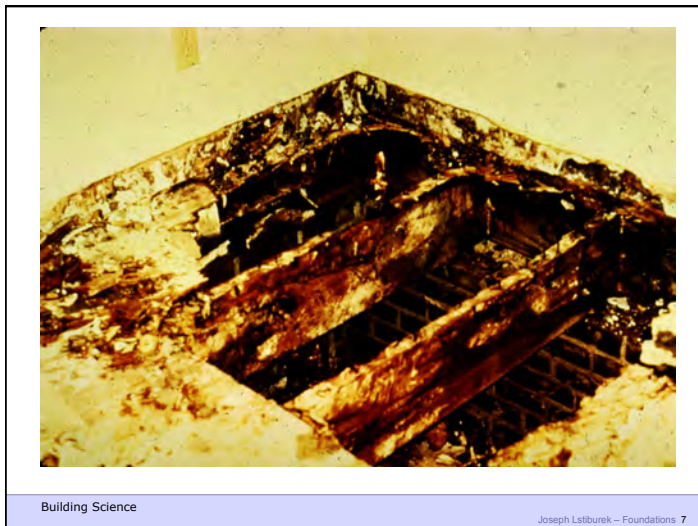
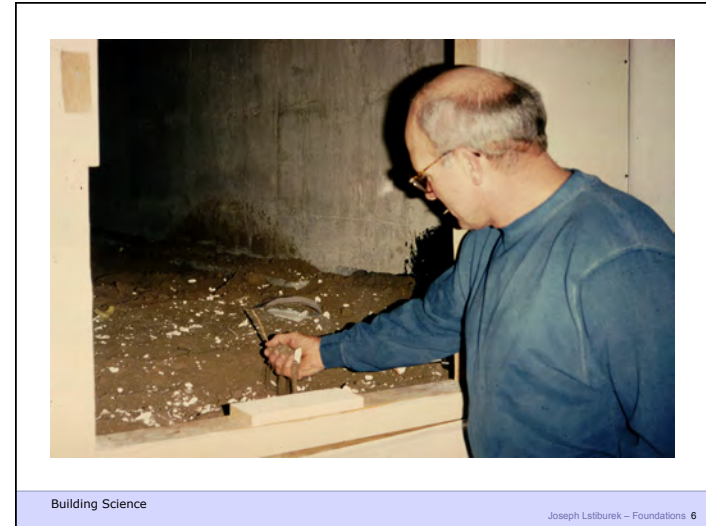
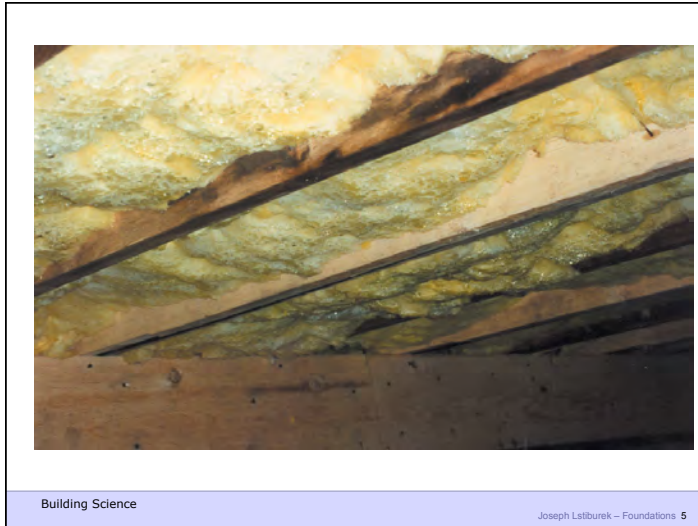





Building Science

Joseph Lstiburek – Foundations 13

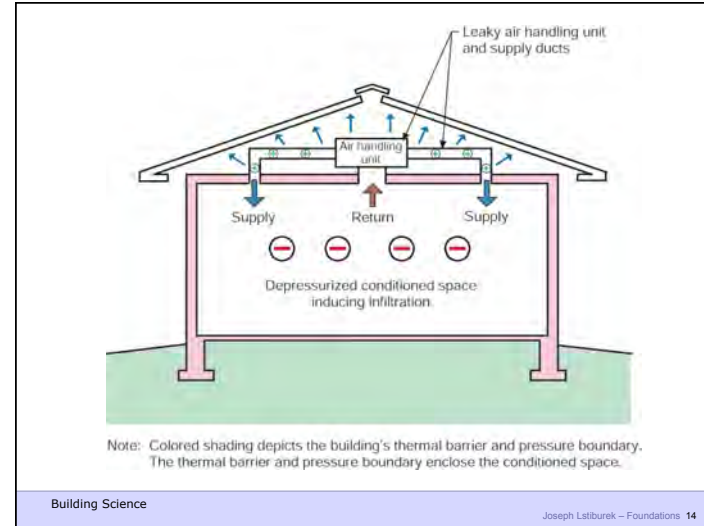

Building Science

Joseph Lstiburek – Foundations 14

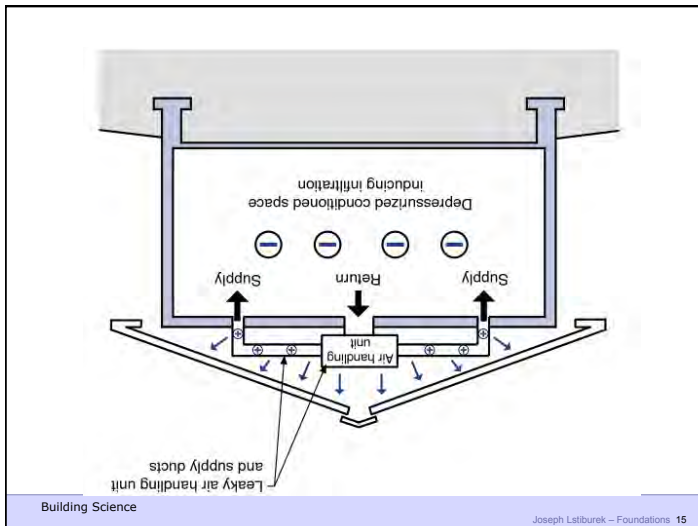

Building Science

Joseph Lstiburek – Foundations 15

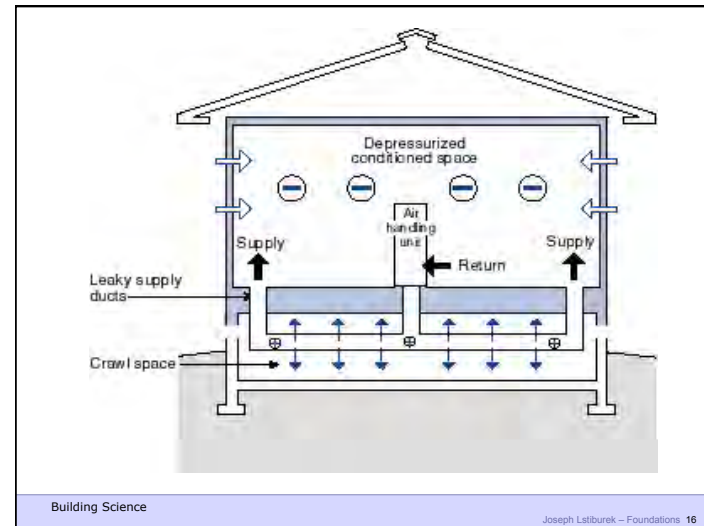

Building Science

Joseph Lstiburek – Foundations 16

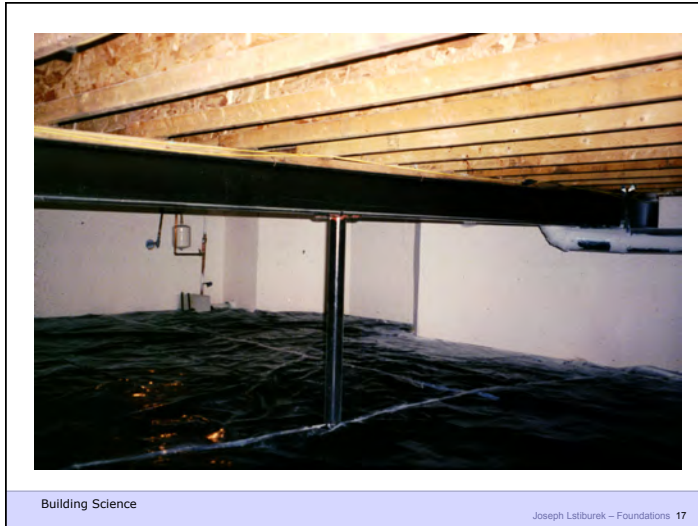

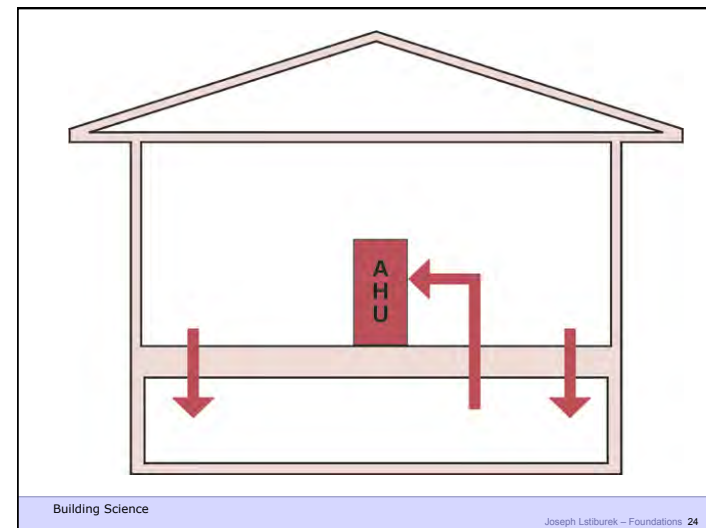
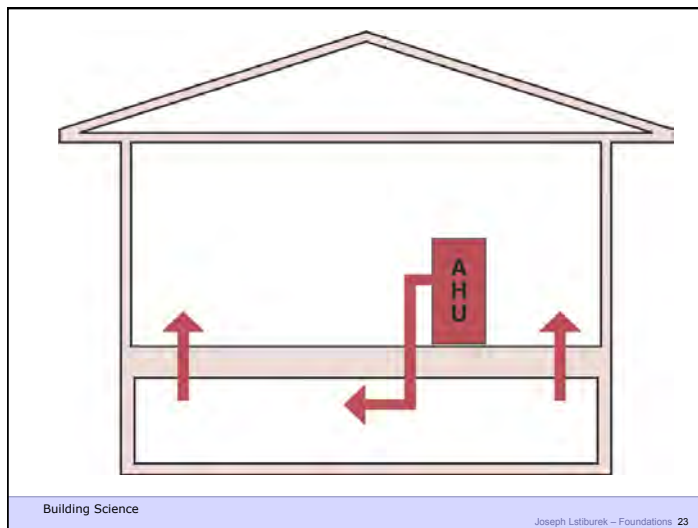
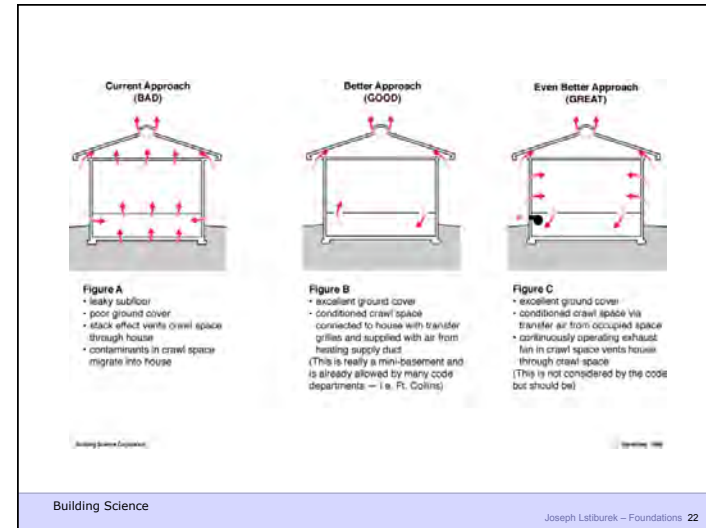

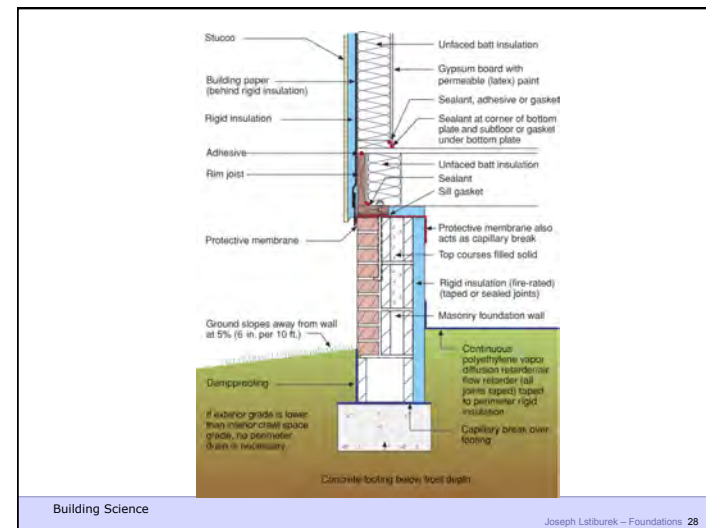
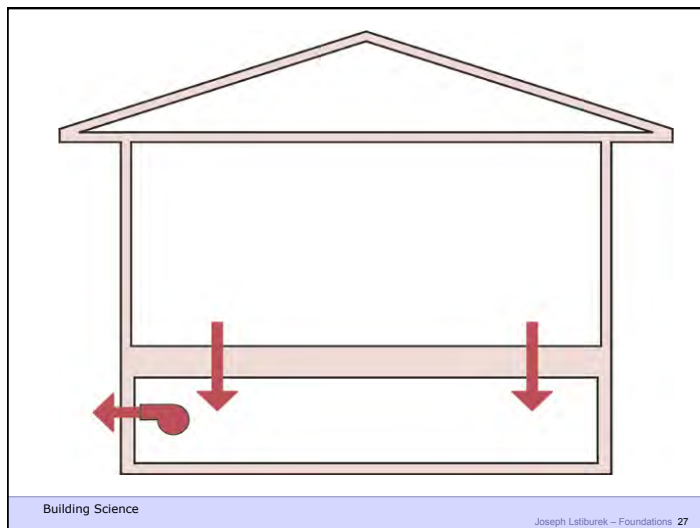
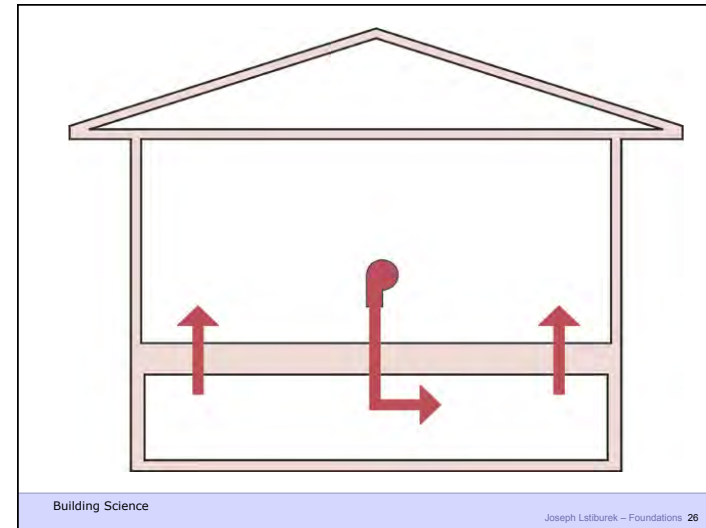
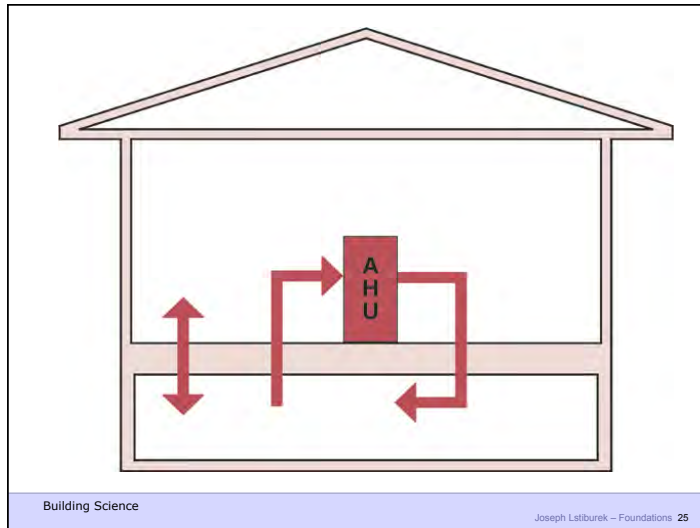

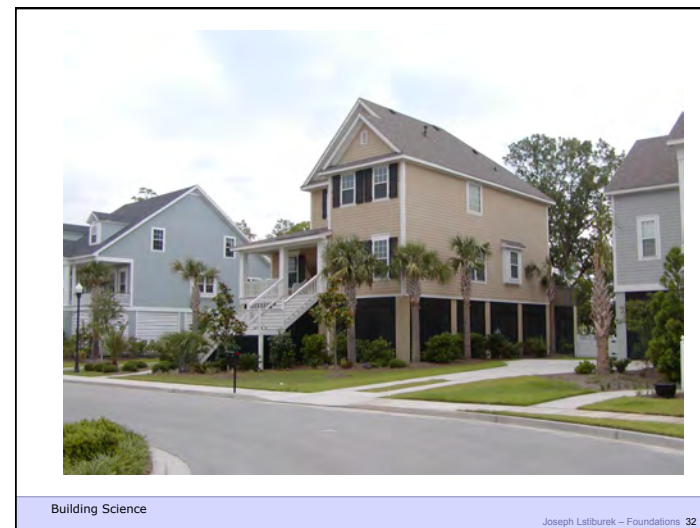
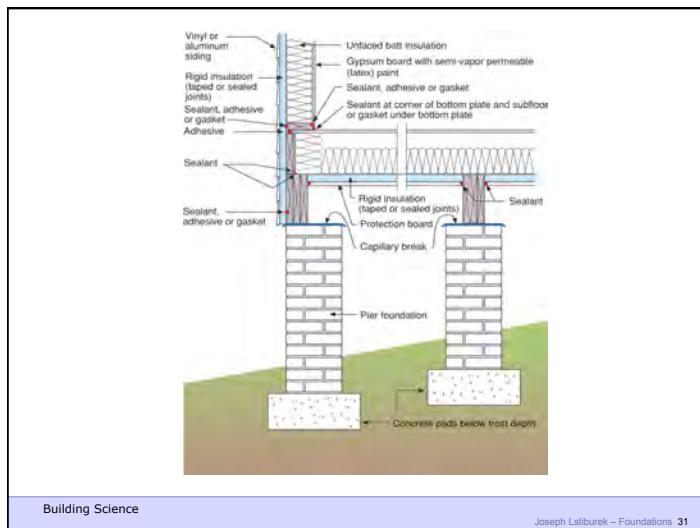
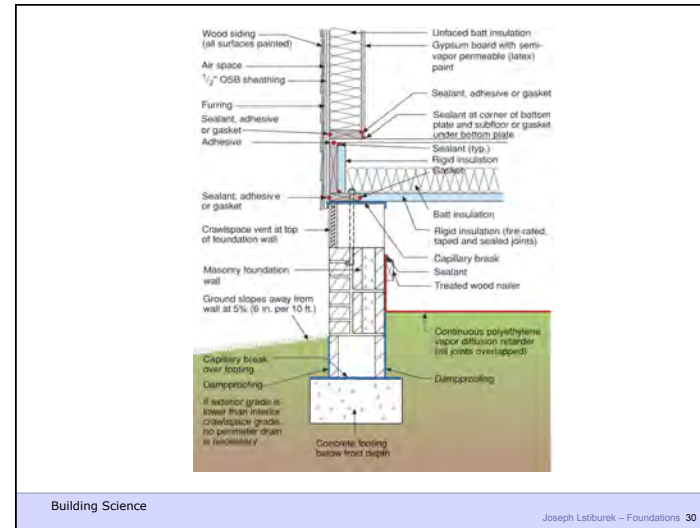
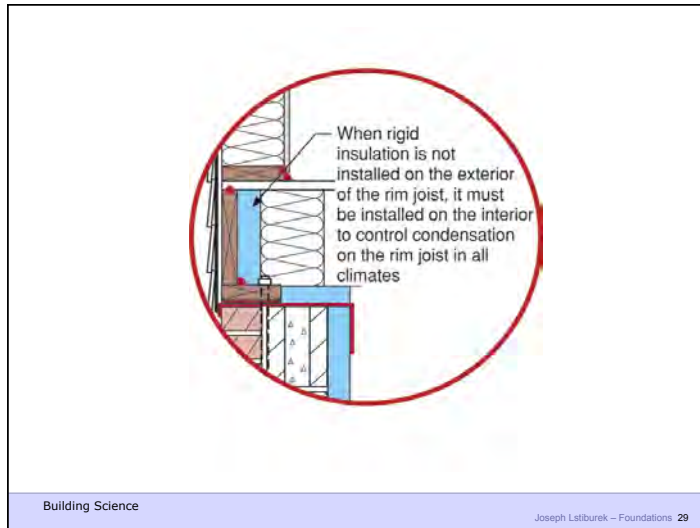

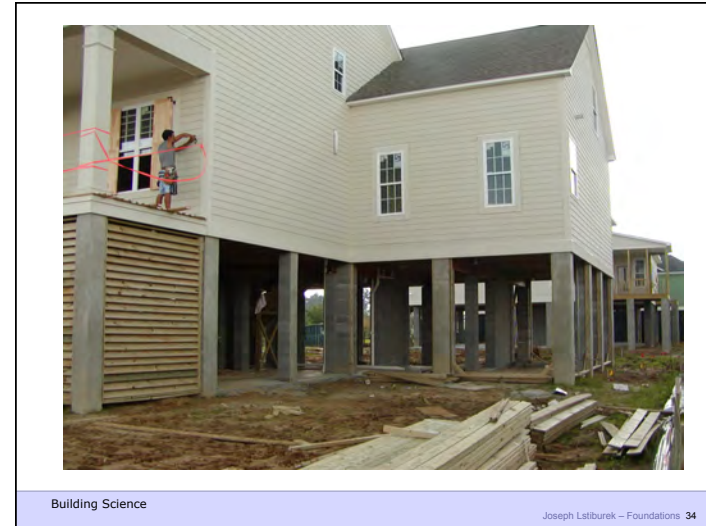
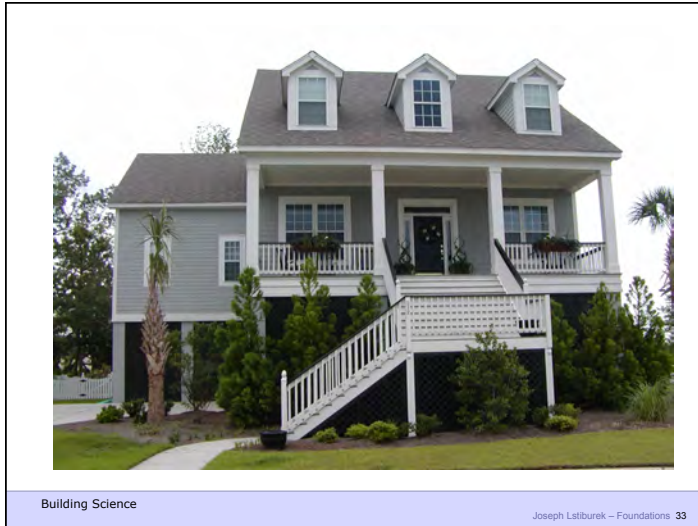

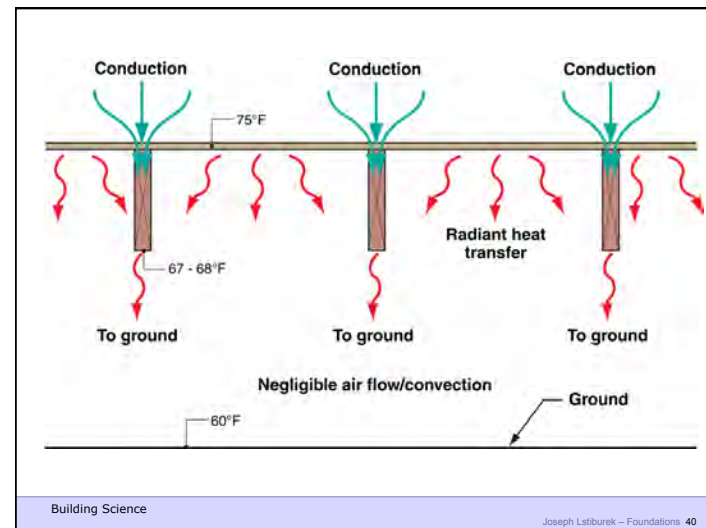
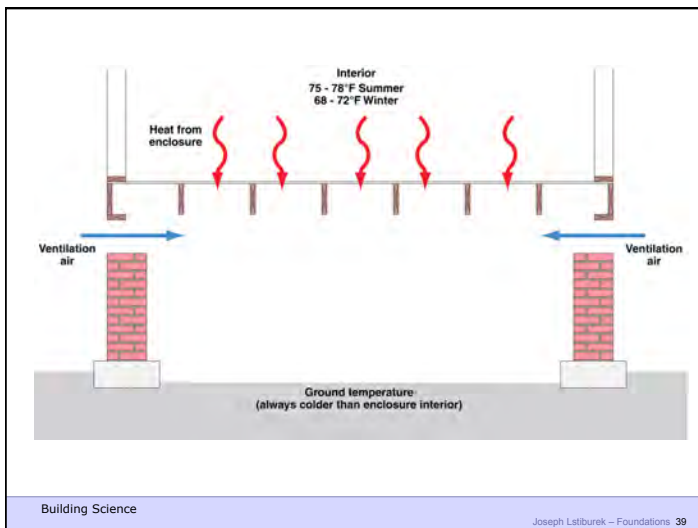
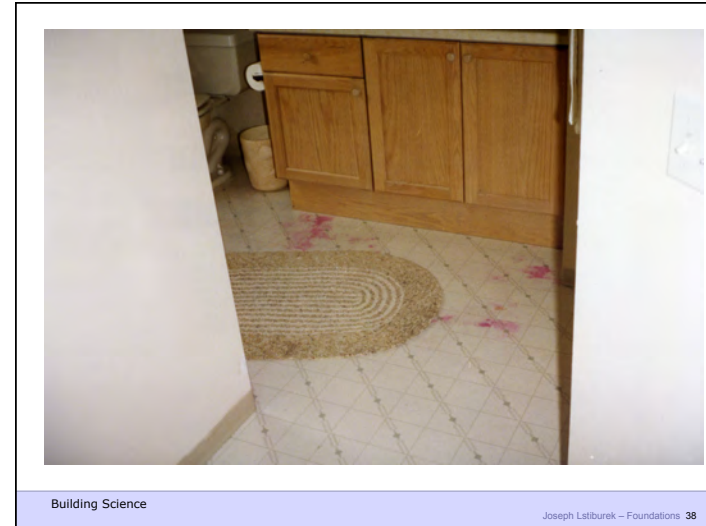

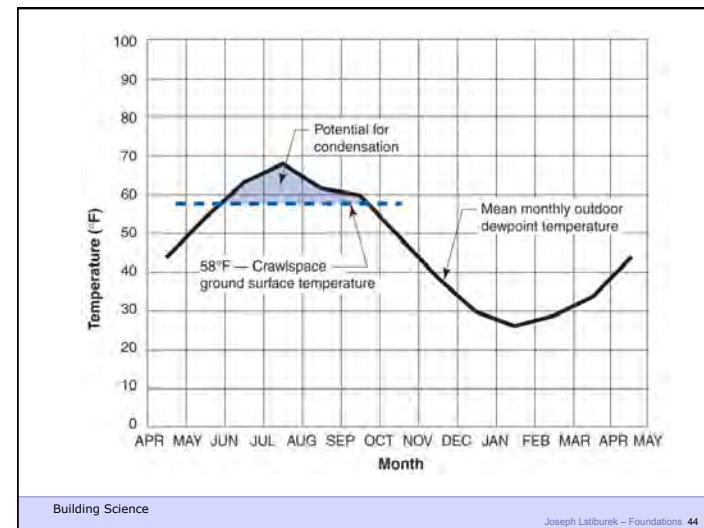
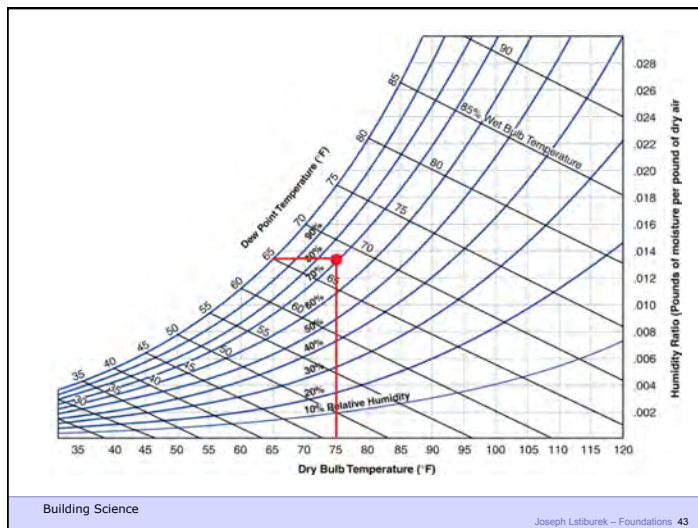
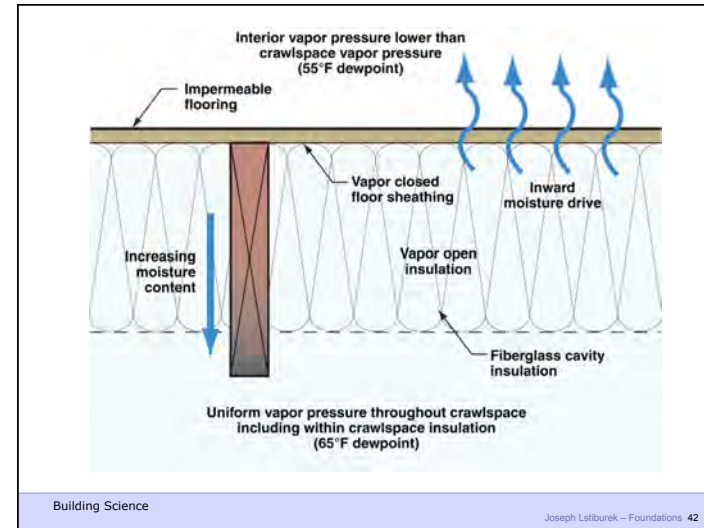
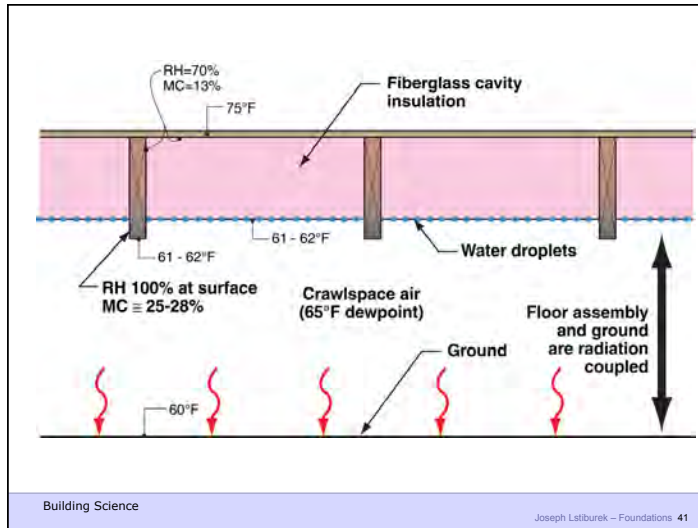

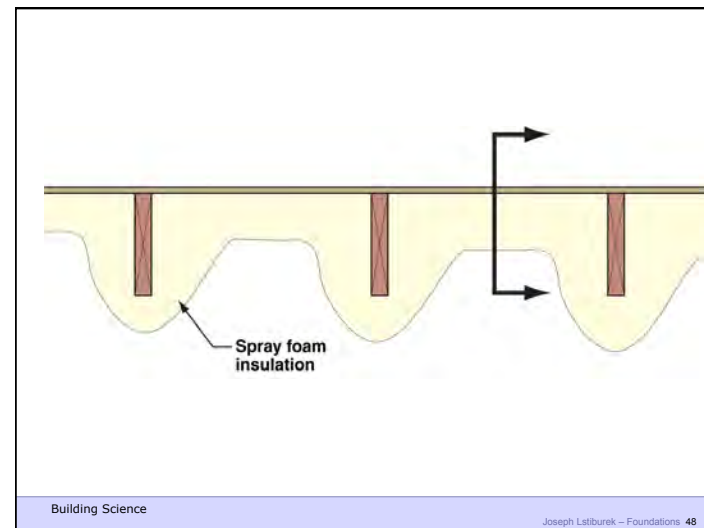
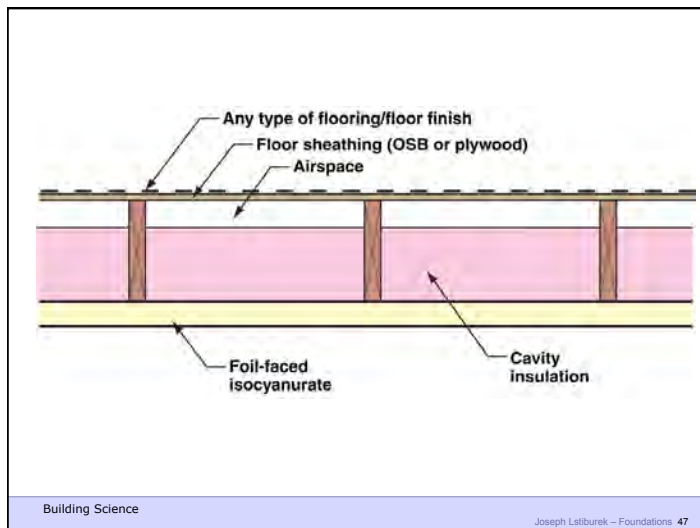
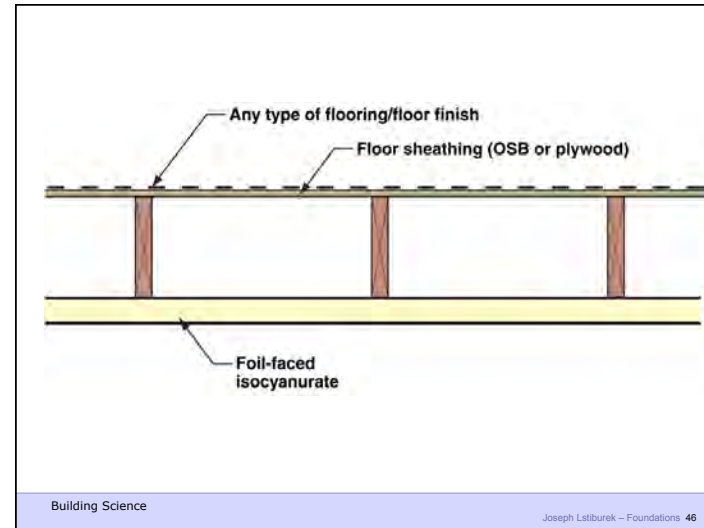
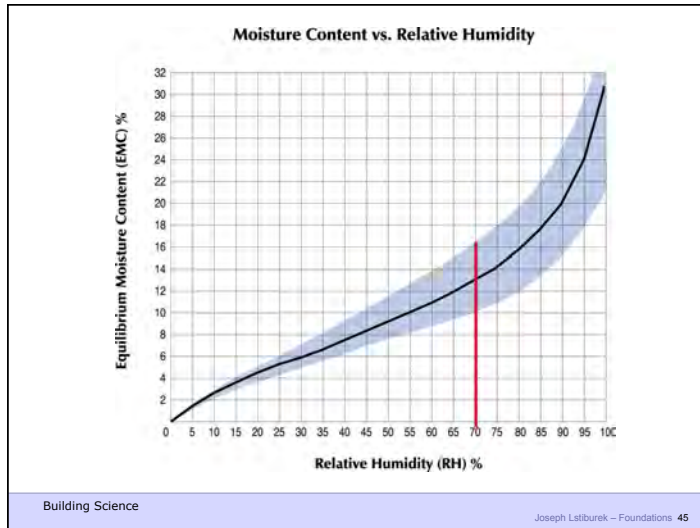

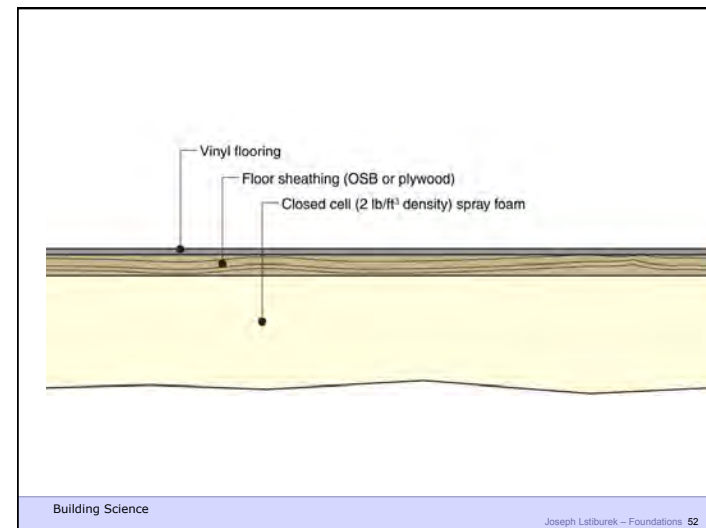
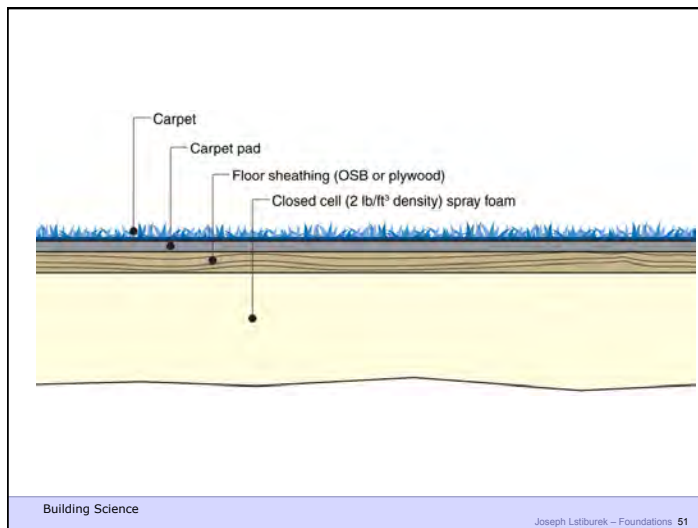
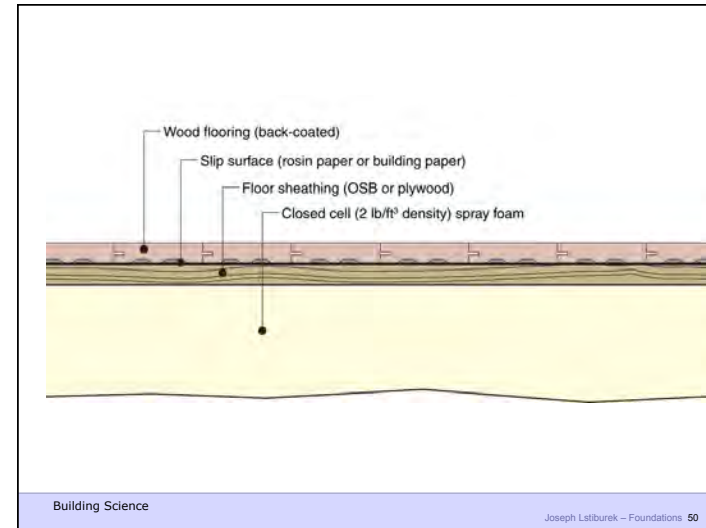
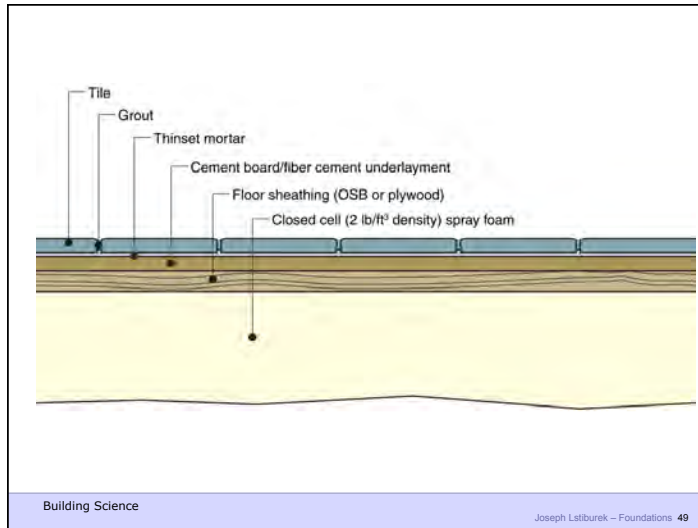

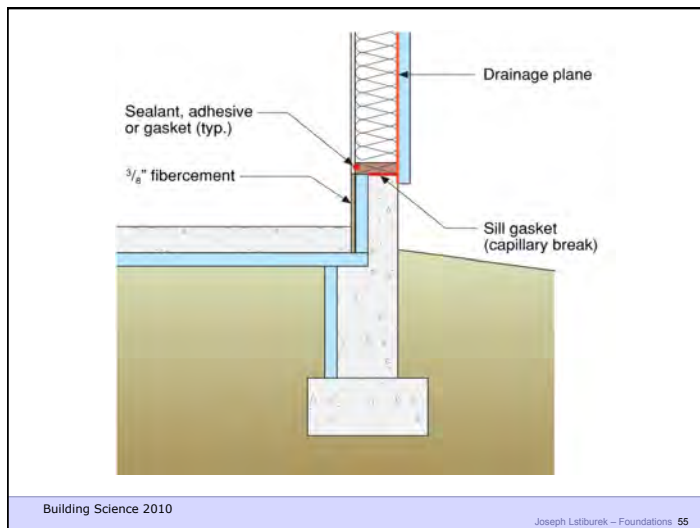
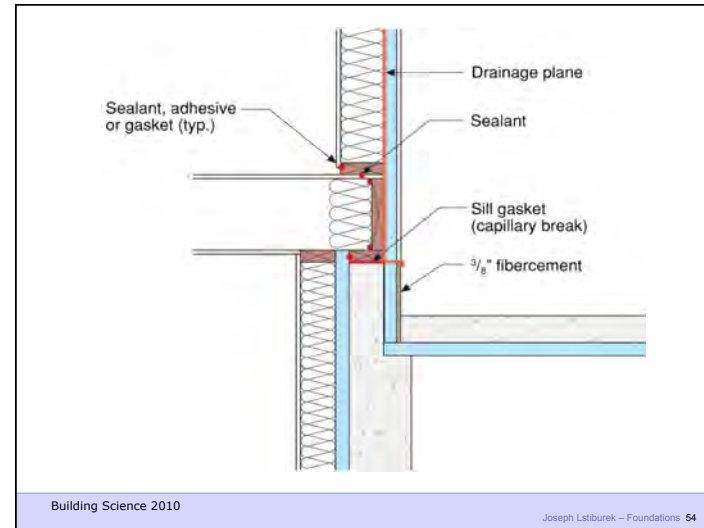
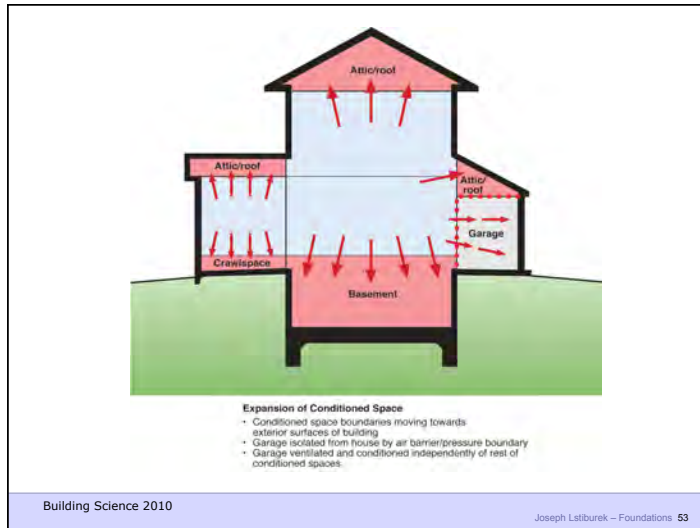

Mechanisms of Flow

- Liquid

Bulk	Hydrostatic Pressure
Capillary	Concentration Gradient
Osmosis	Concentration Gradient
- Vapor

Diffusion	Vapor Pressure
Air Transport	Air Pressure

Building Science 2010 Joseph Lstiburek – Foundations 56

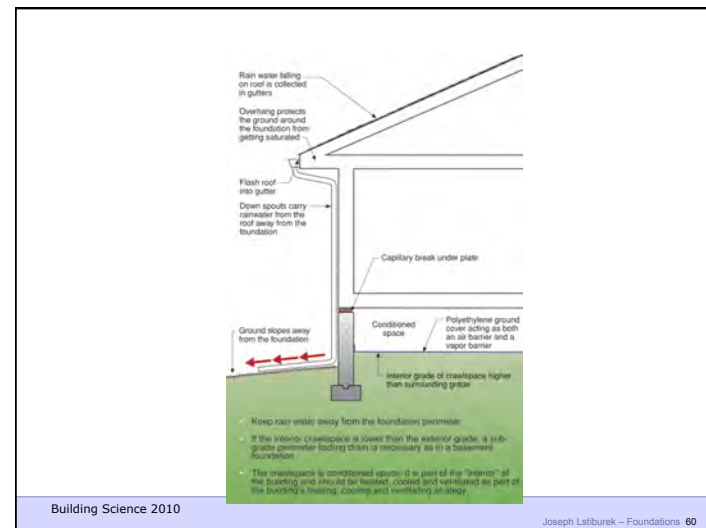
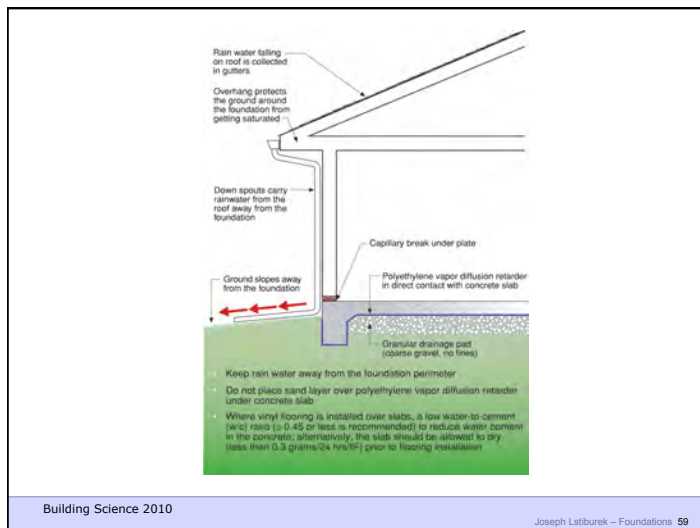
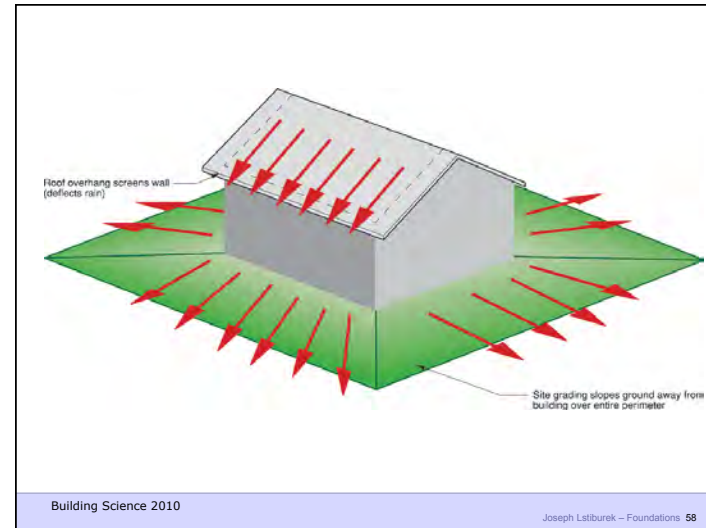
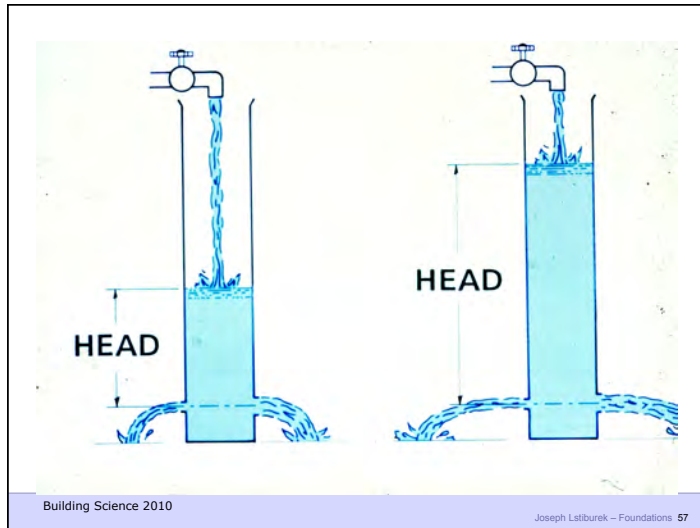

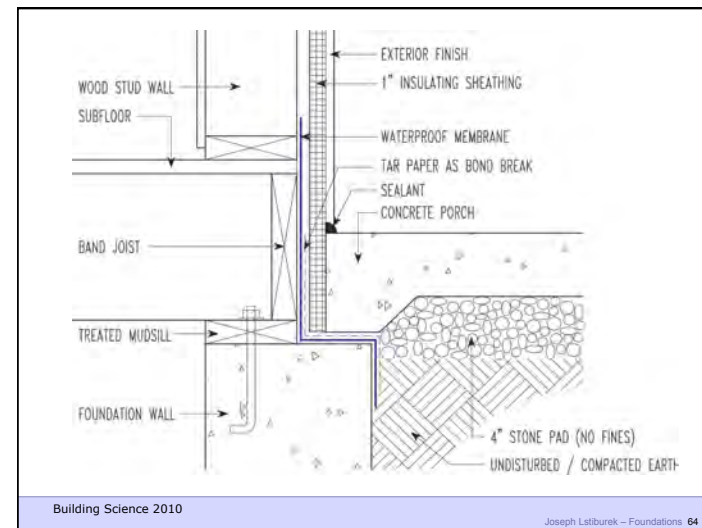
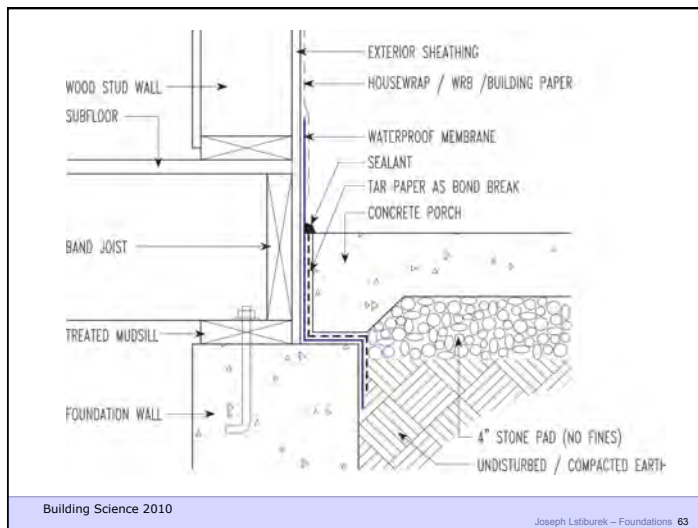
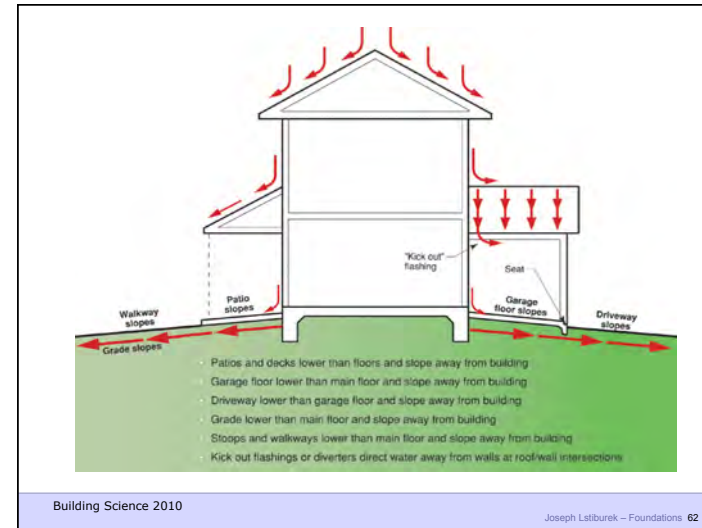
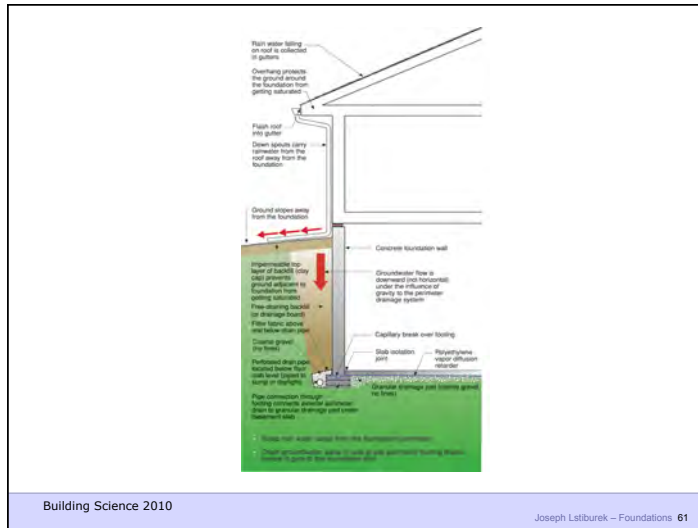

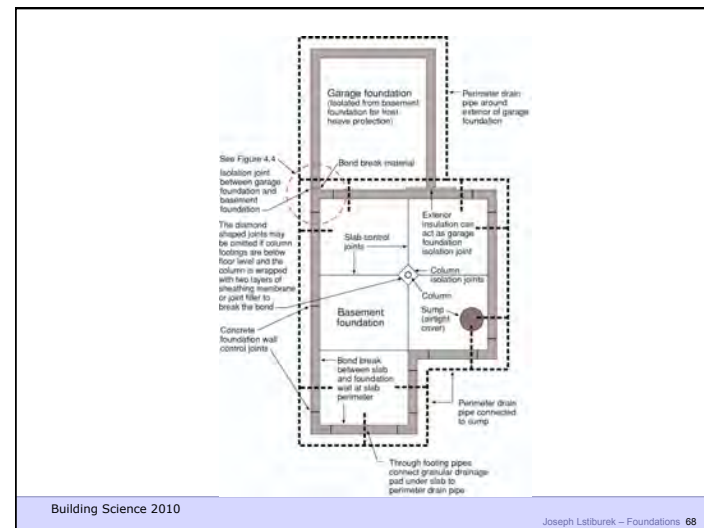
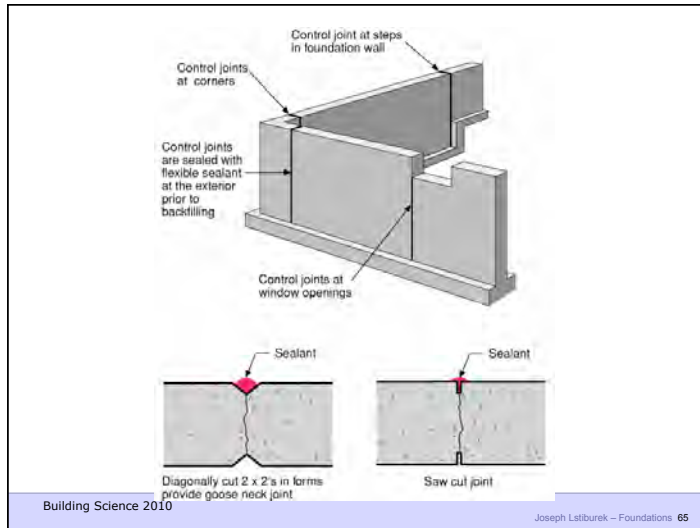

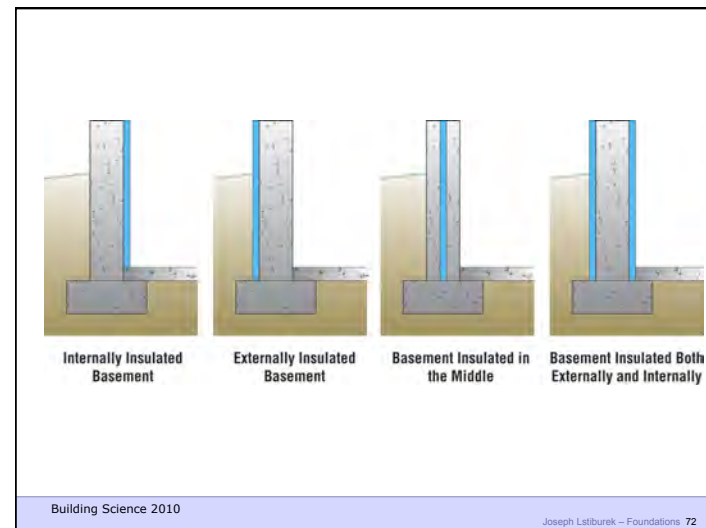

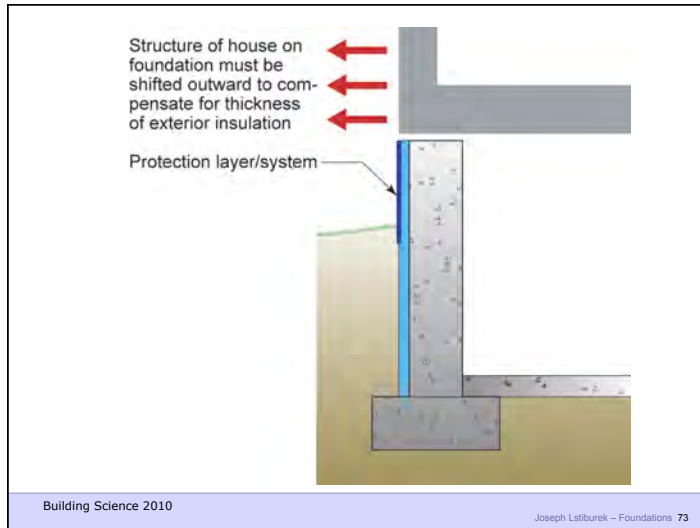



Building Science 2010

Joseph Lstiburek – Foundations 77

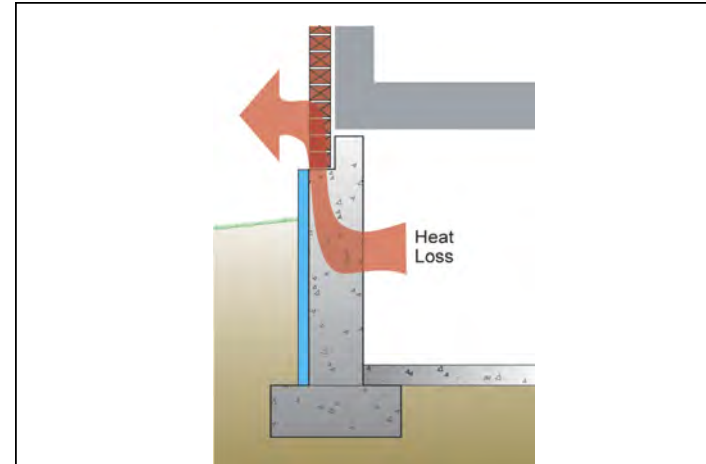

Building Science 2010

Joseph Lstiburek – Foundations 78



Building Science 2010

Joseph Lstiburek – Foundations 79



Building Science 2010

Joseph Lstiburek – Foundations 80

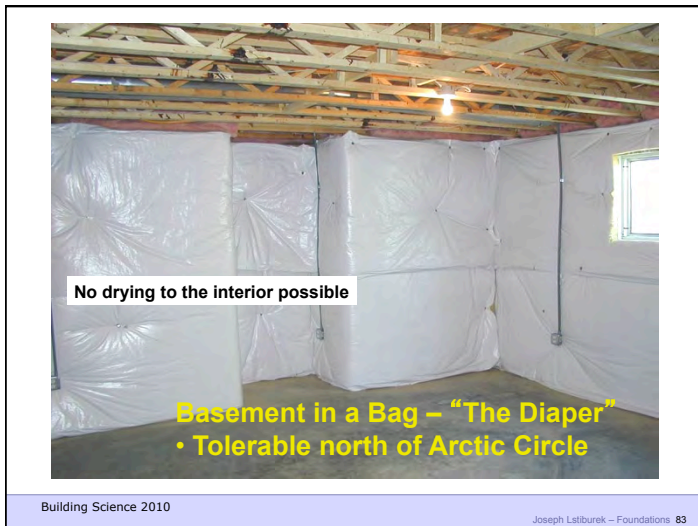

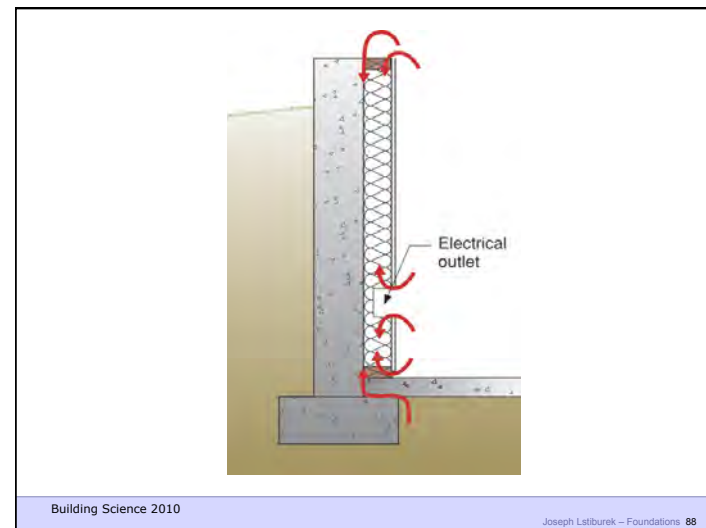
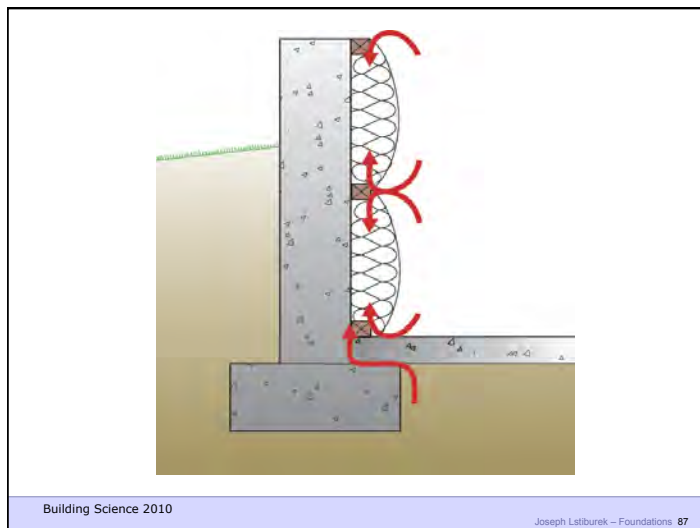
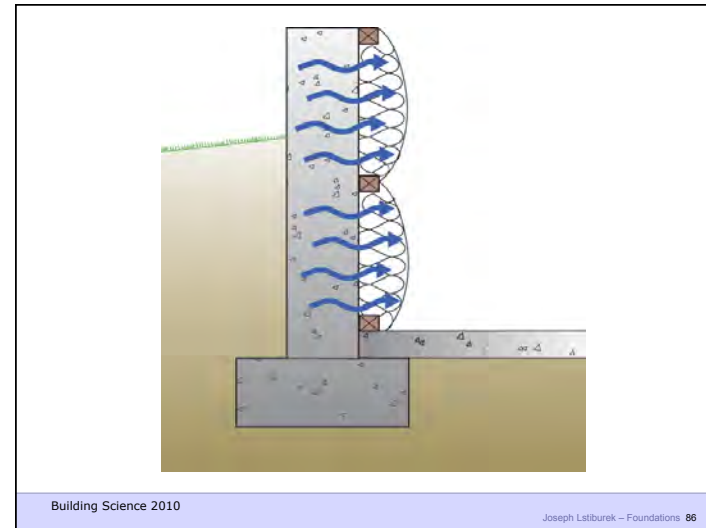
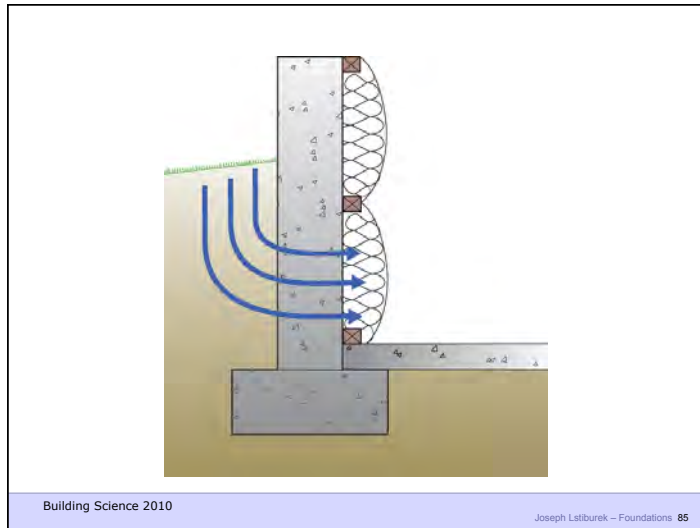

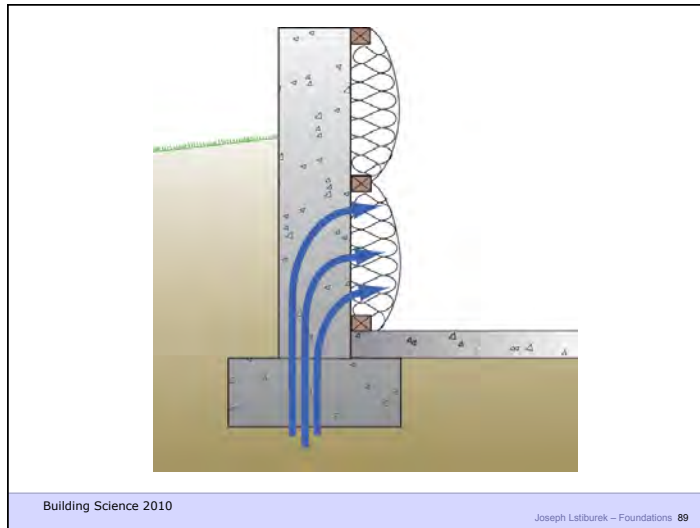

Surface Tension: Wettable

Water attracted to surface more than self

$\theta < 90^\circ$

normal material:
"wetable"

Water attracted to self more than surface

$\theta > 90^\circ$

hydrophobically treated:
"non-wetable"

Building Science 2010 Joseph Lstiburek - Foundations 90

Capillary Pressures

- Result of surface tension = attraction to surfaces
 - pressure varies with pore size
 - e.g., height rise in a glass tube

Building Science 2010 Joseph Lstiburek - Foundations 91

Calculating capillary rise

$$h = \frac{2 \sigma \cos \theta}{g \rho r}$$

Building Science 2010 Joseph Lstiburek - Foundations 92

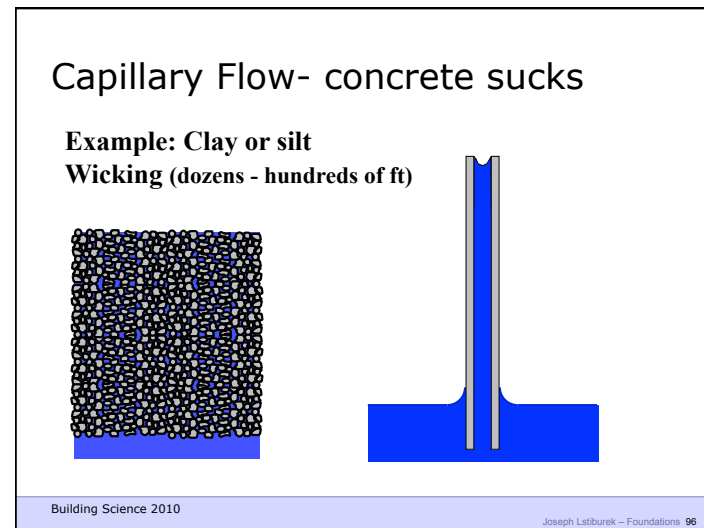
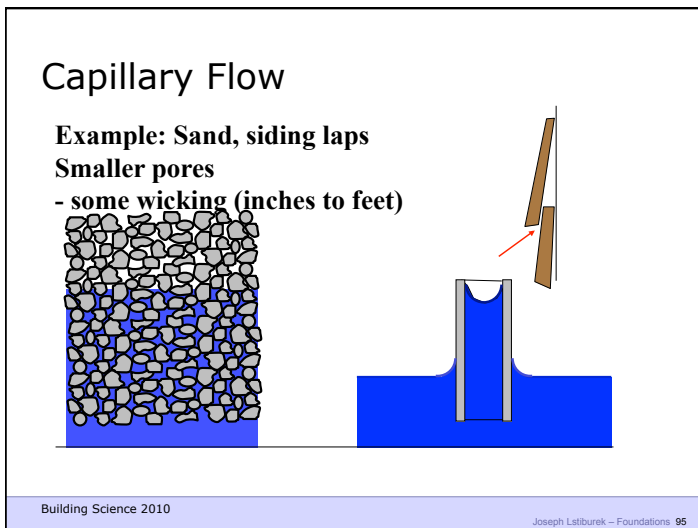
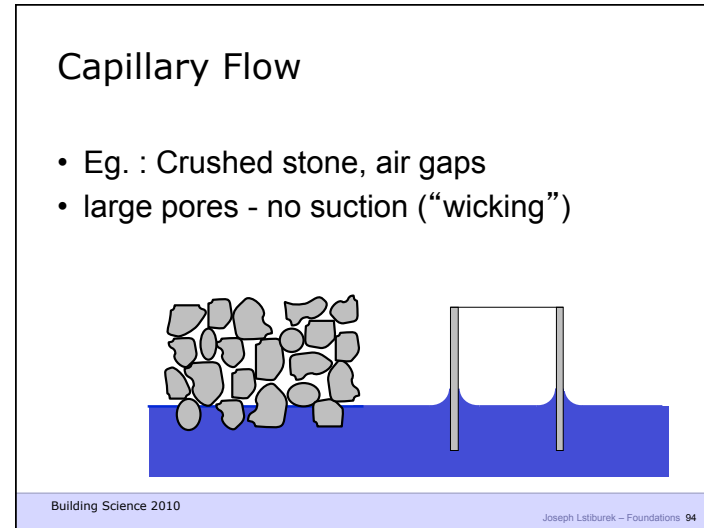
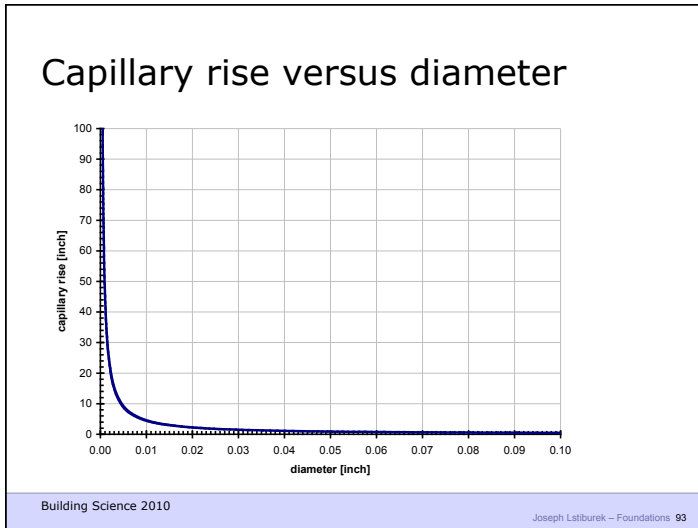

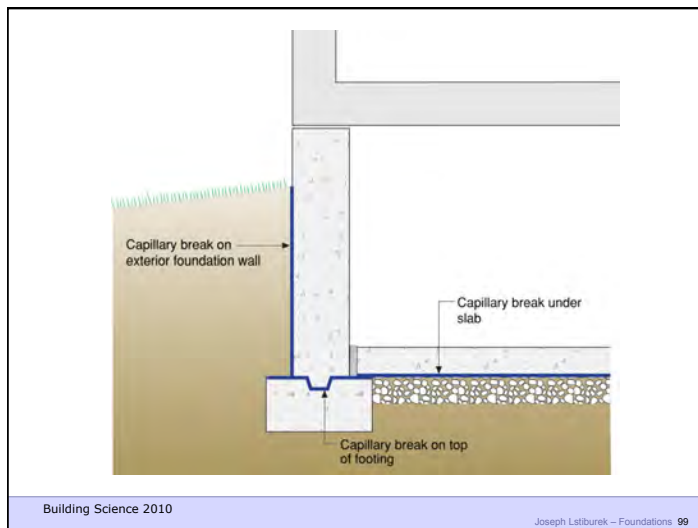
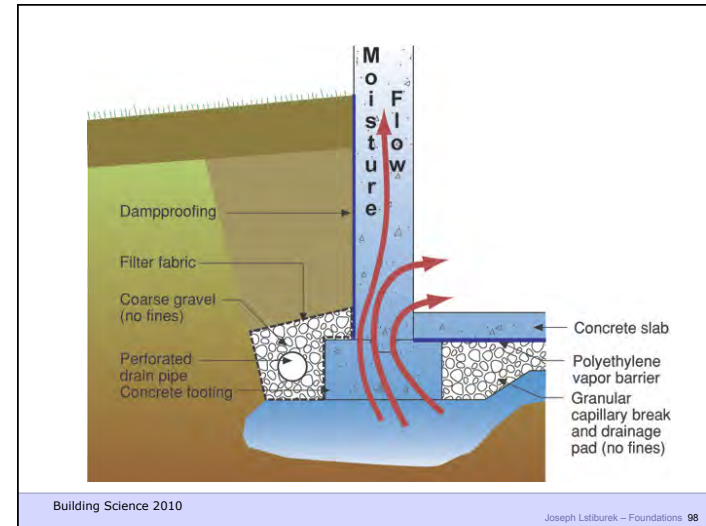

Capillarity + Salt = Osmosis

- Mineral salts carried in solution by capillary water
- When water evaporates from a surface the salts left behind form crystals in process called efflorescence
- When water evaporated beneath a surface the salts crystallize within the pore structure of the material in called sub-efflorescence
- The salt crystallization causes expansive forces that can exceed the cohesive strength of the material leading to spalling

Building Science 2010

Joseph Lstiburek – Foundations 100

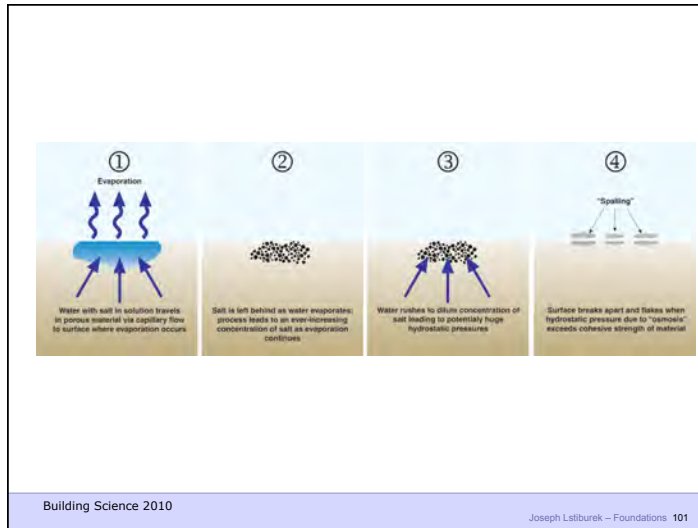

Diffusion + Capillarity + Osmosis = Problem

- Diffusion Vapor Pressure 3 to 5 psi
- Capillary Pressure 300 to 500 psi
- Osmosis Pressure 3,000 to 5,000 psi

Building Science 2010 Joseph Lstiburek - Foundations 102

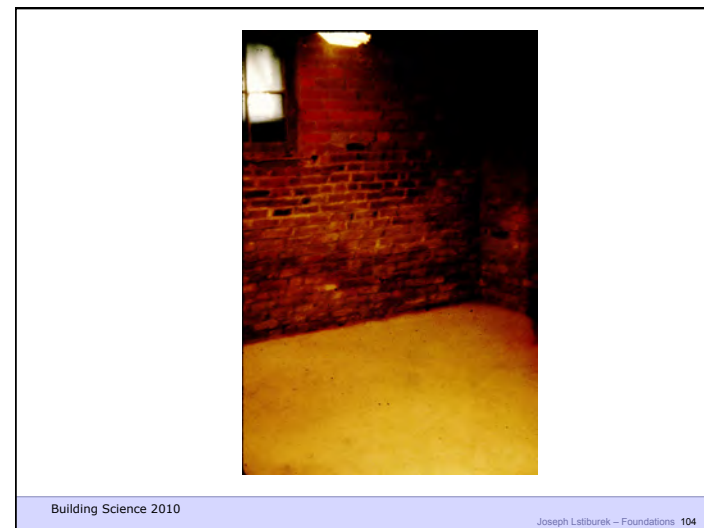

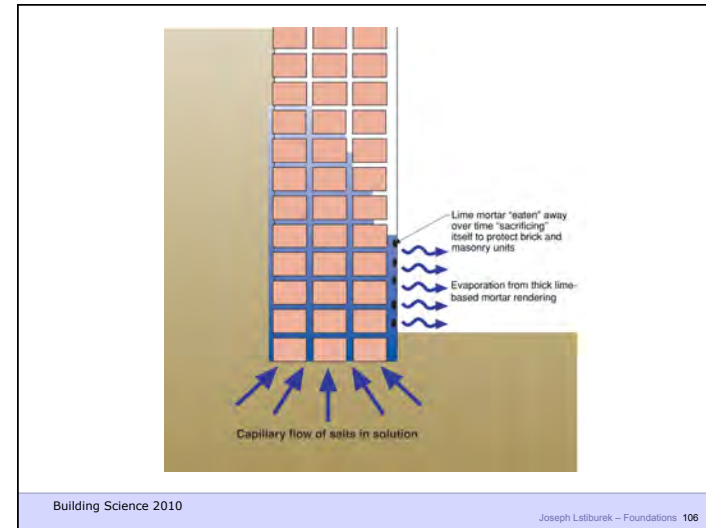
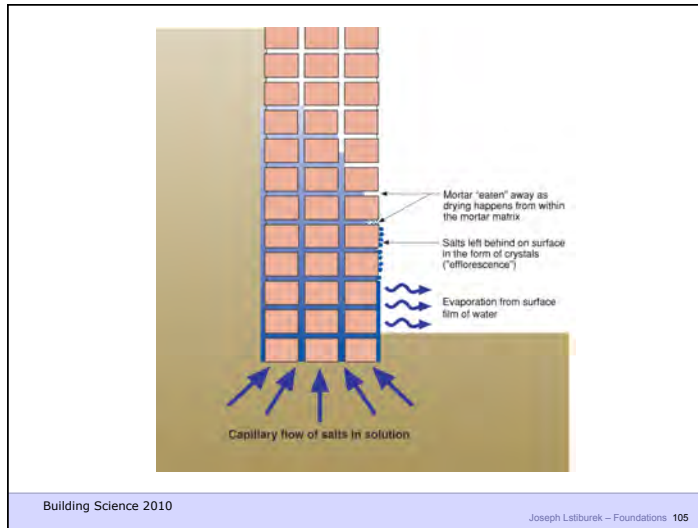

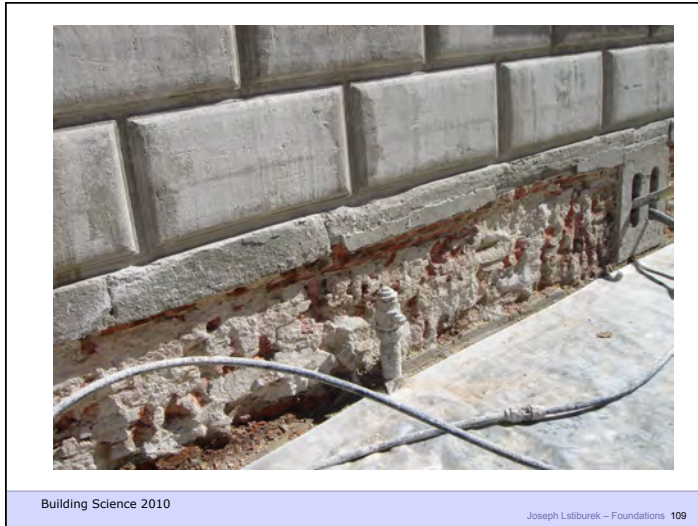

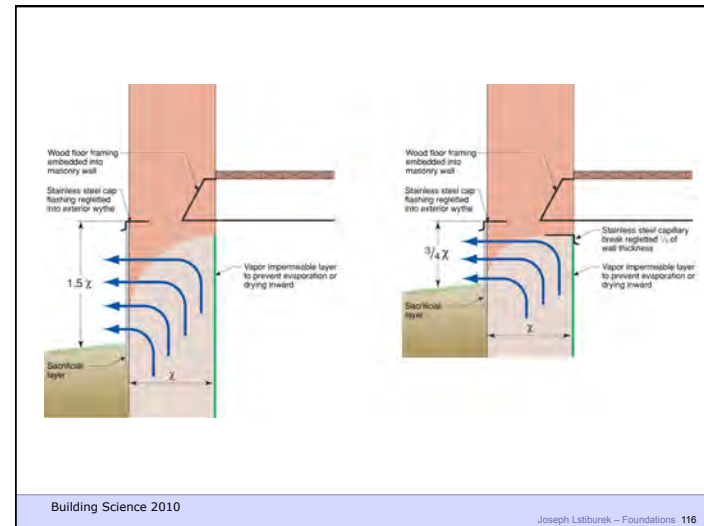
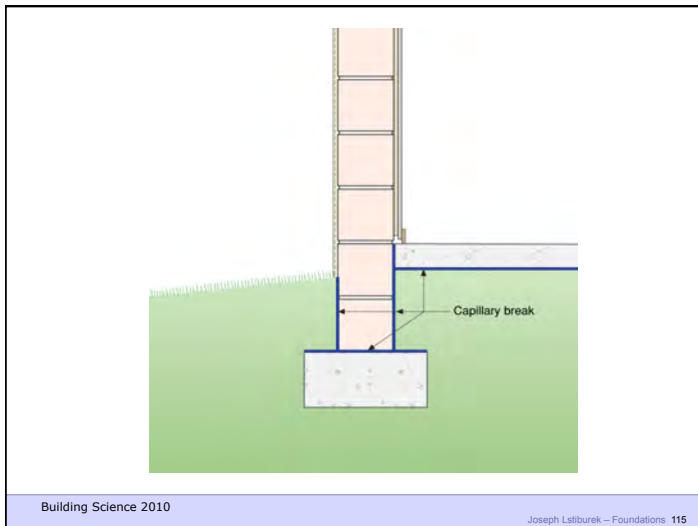
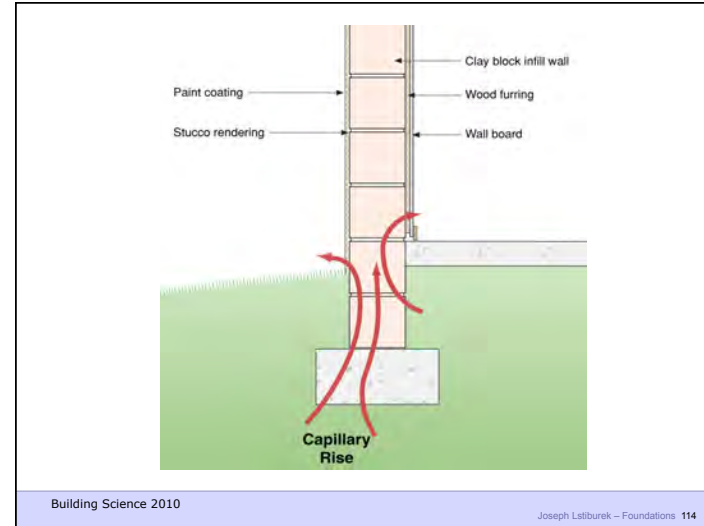

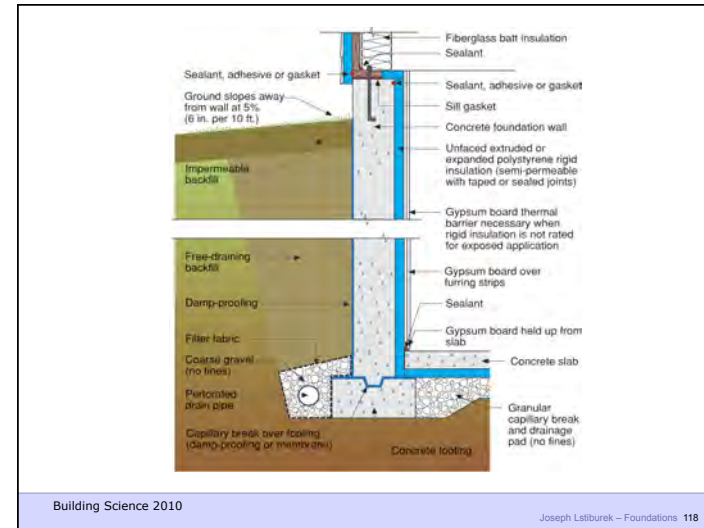
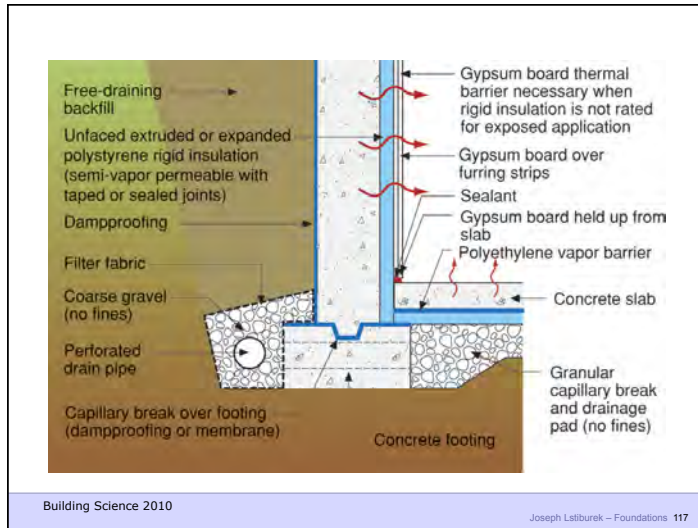

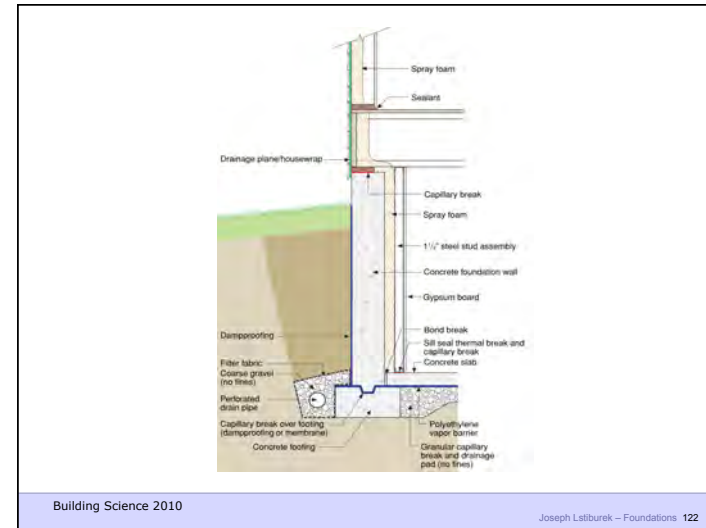
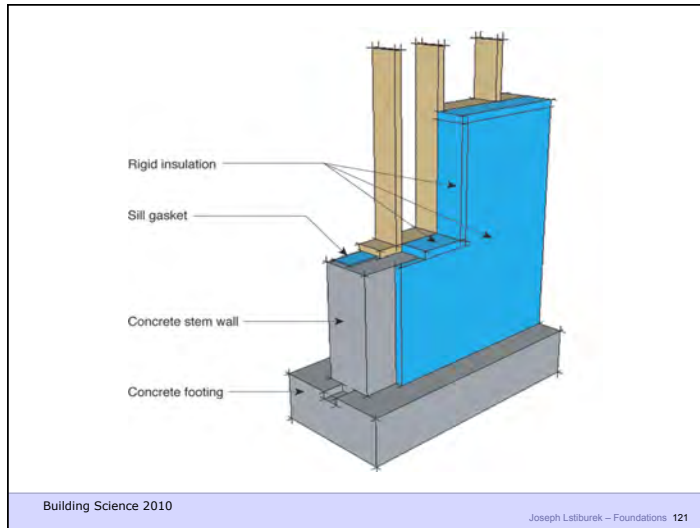

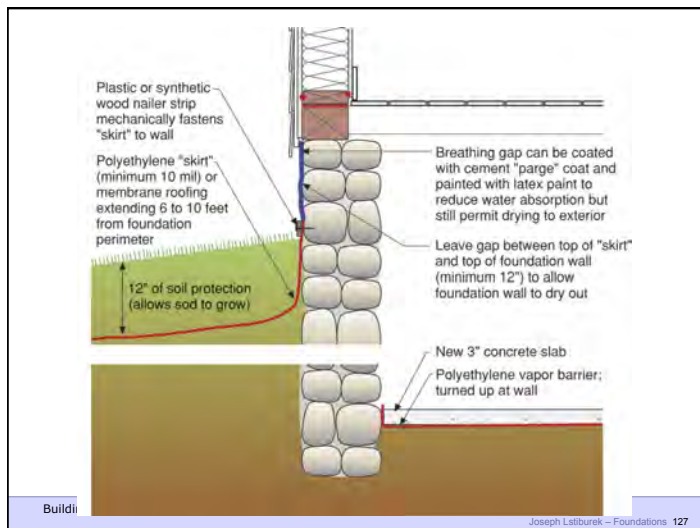

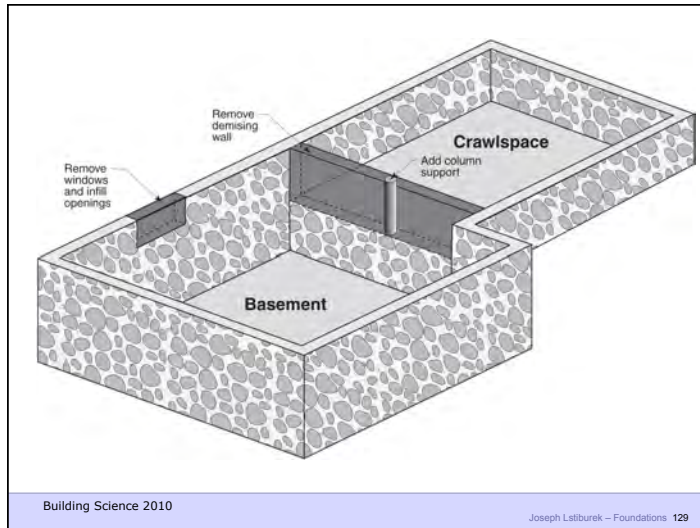

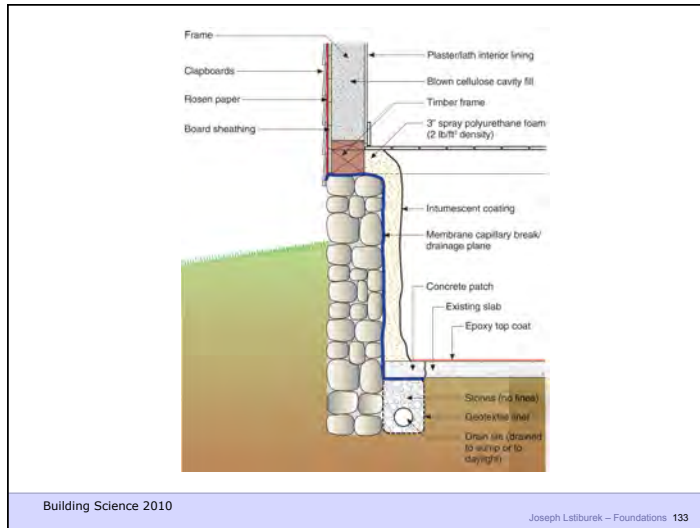

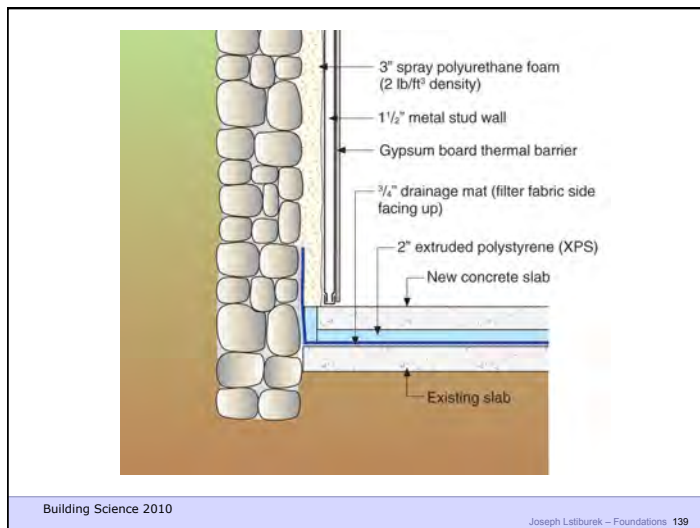





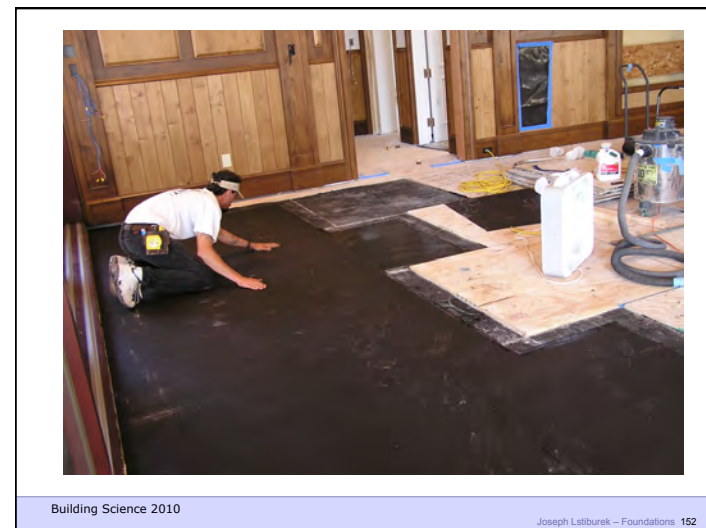
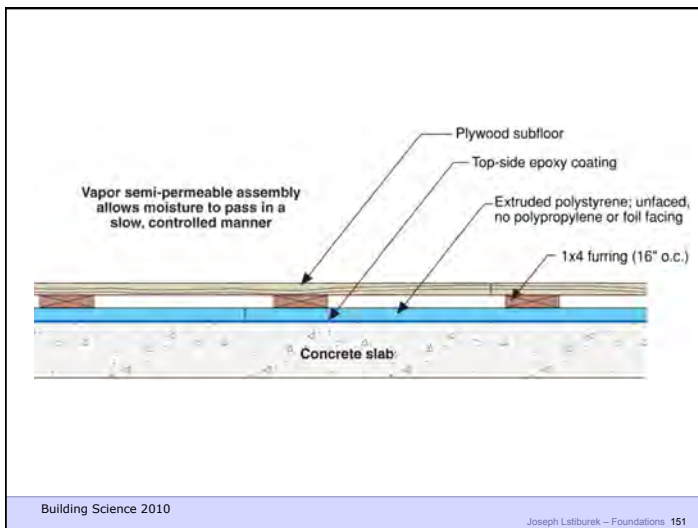

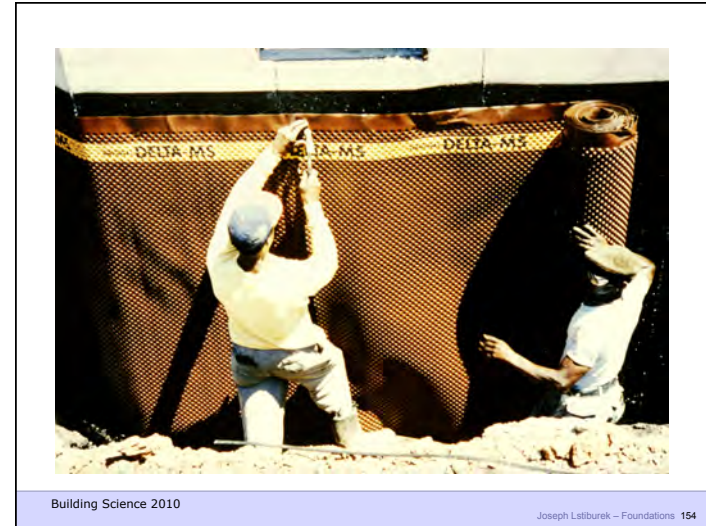
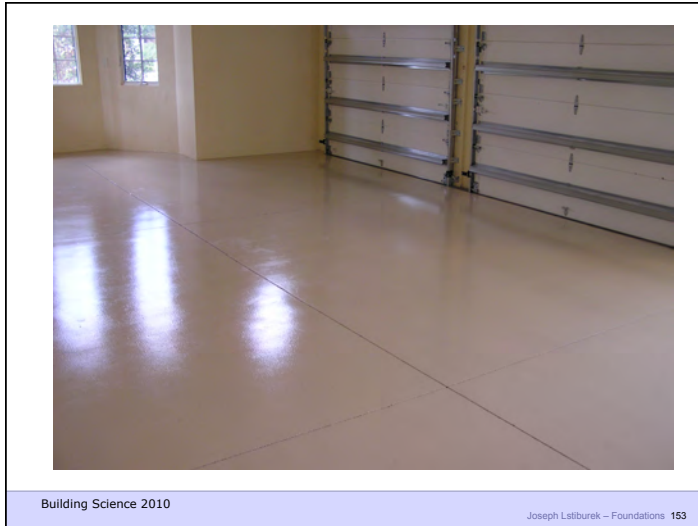

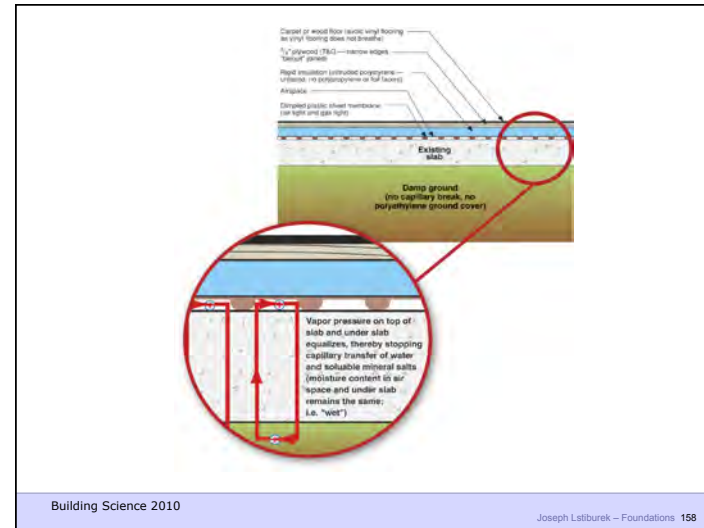

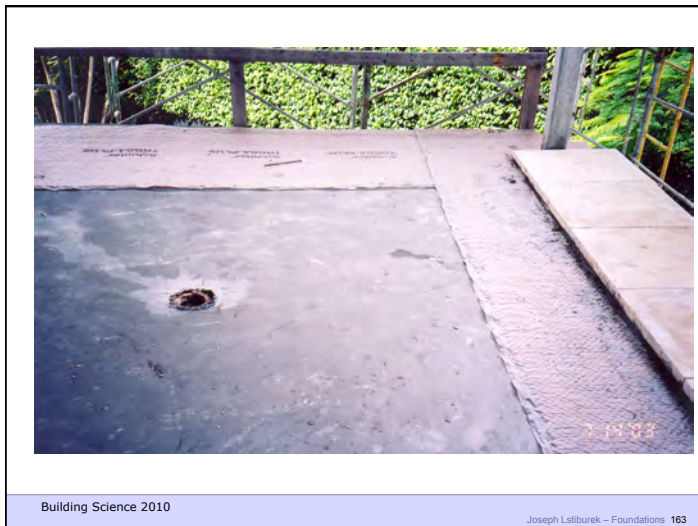
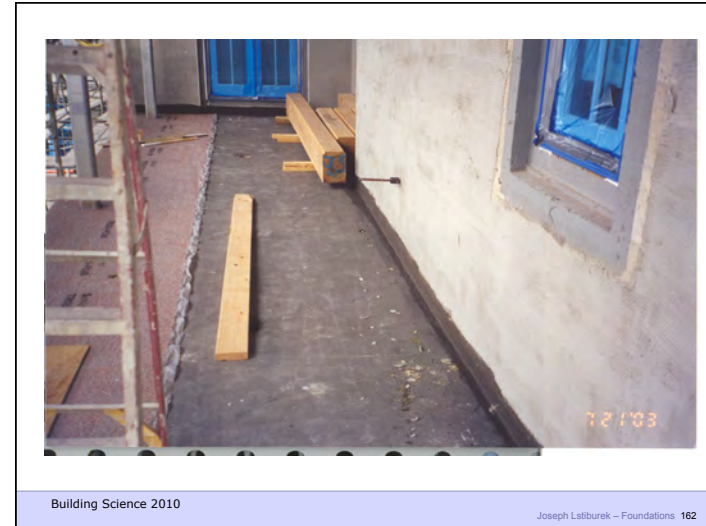



Building Science 2010

Joseph Lstiburek - Foundations 165



Building Science 2010

Joseph Lstiburek - Foundations 166



Building Science 2010

Joseph Lstiburek - Foundations 167

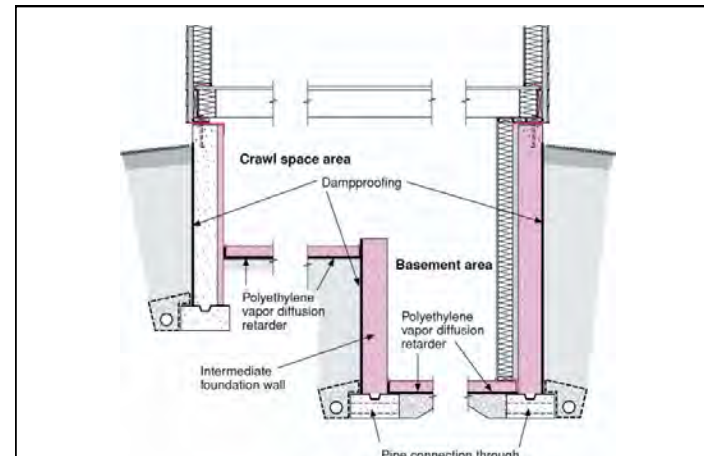

Building Sci

Joseph Lstiburek - Foundations 168

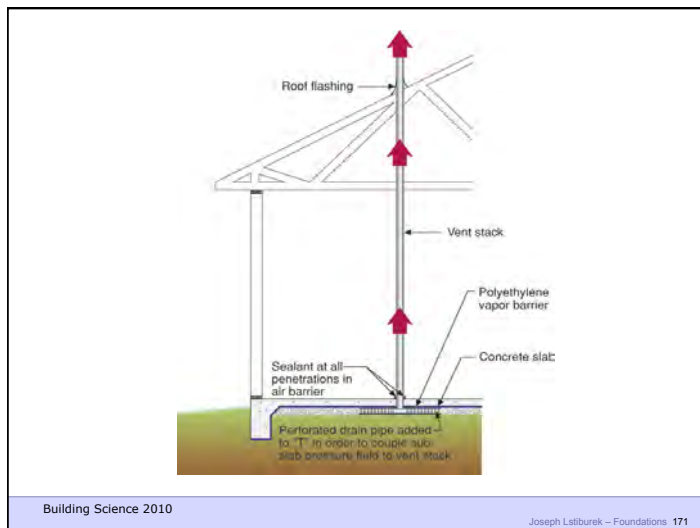
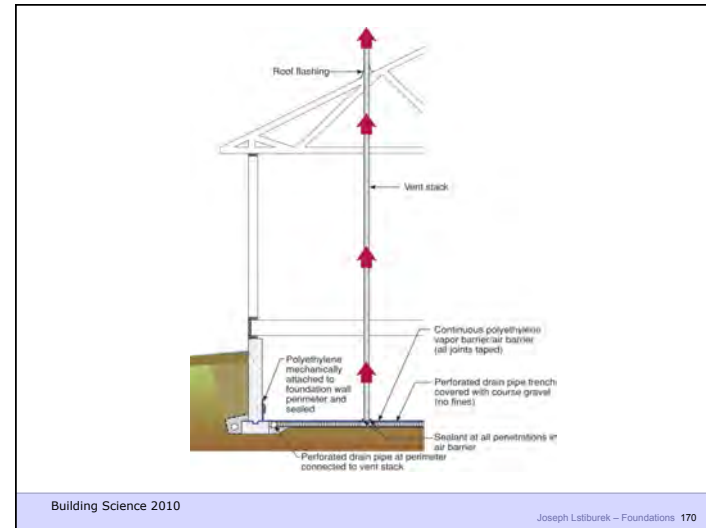
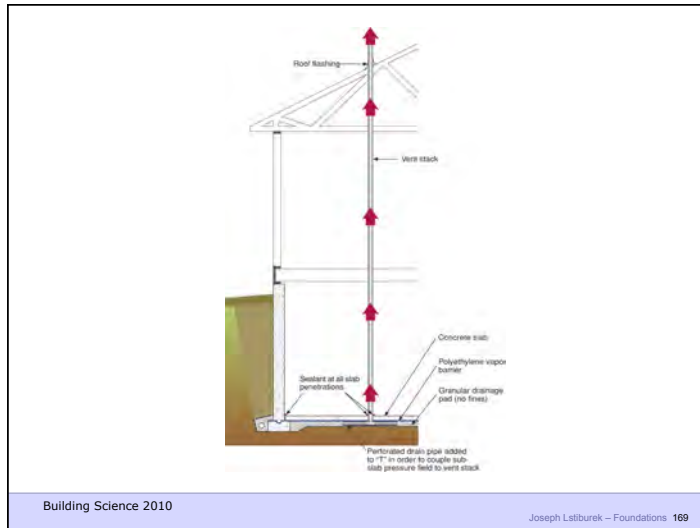

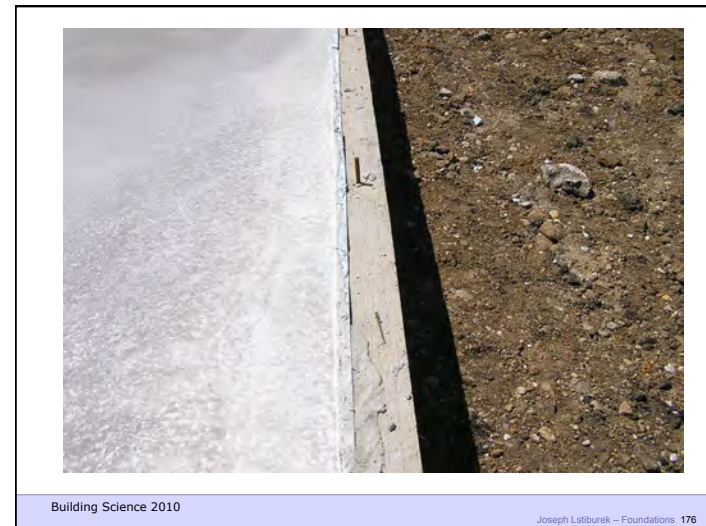

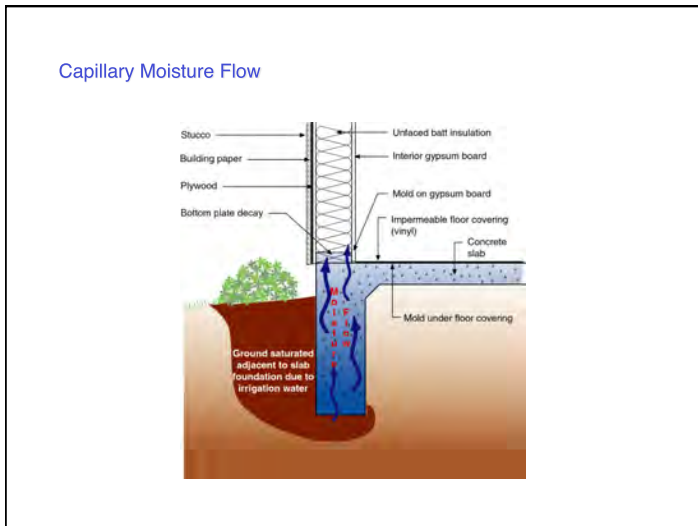
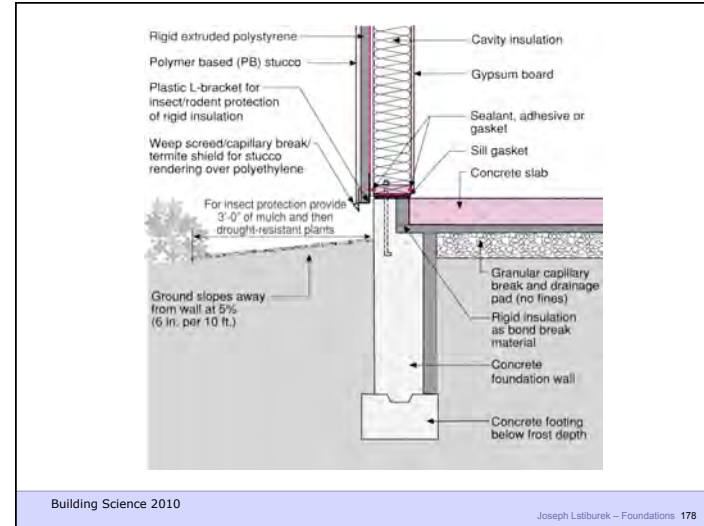

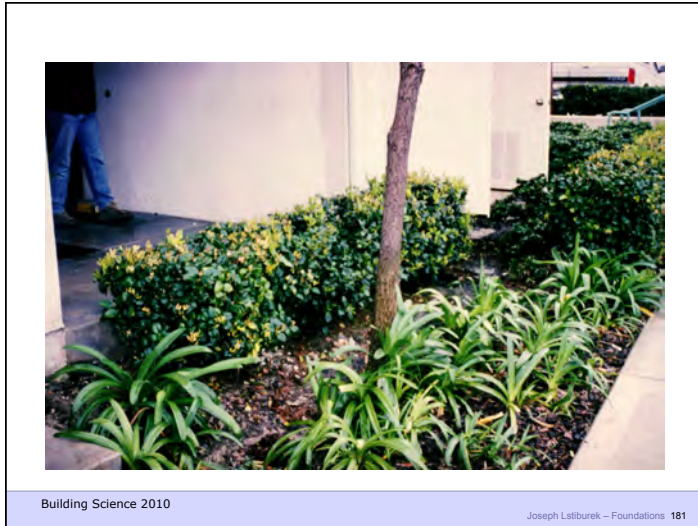

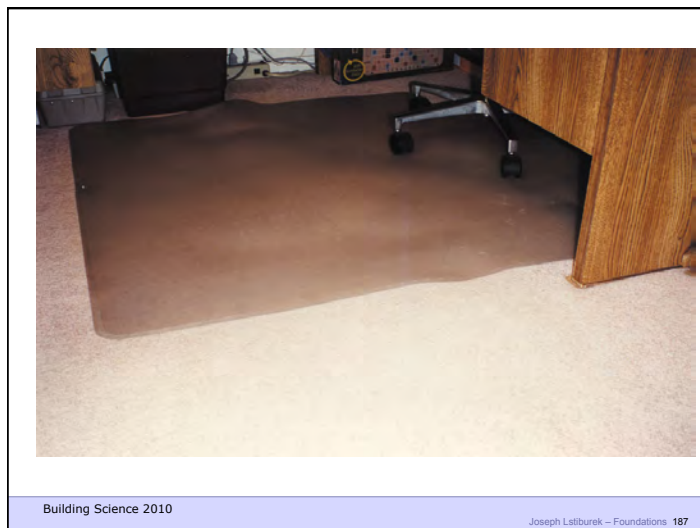
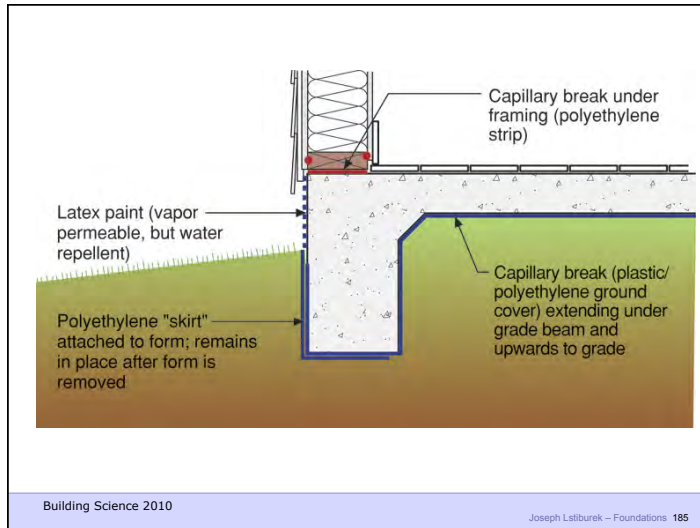

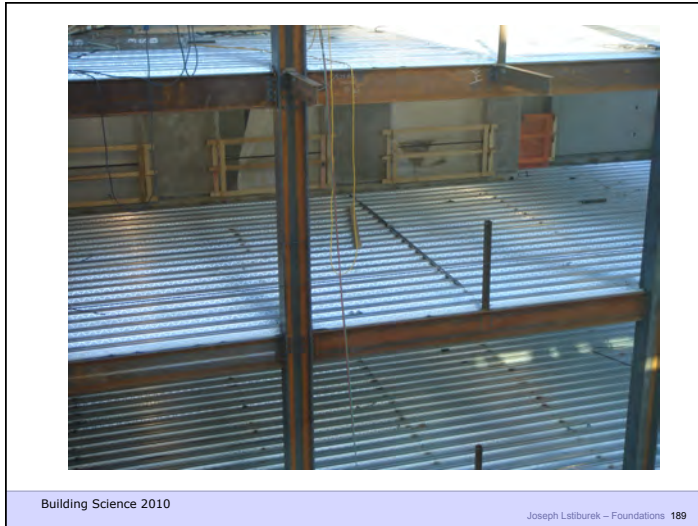

Building Science 2010

Joseph Lstiburek – Foundations 189

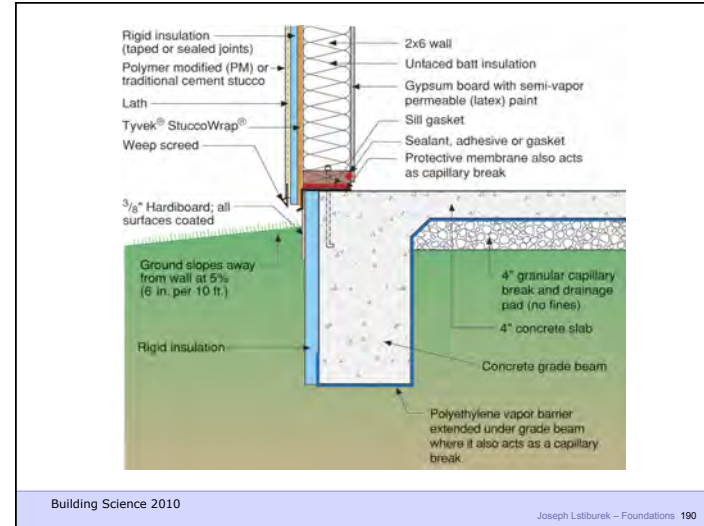

Building Science 2010

Joseph Lstiburek – Foundations 190

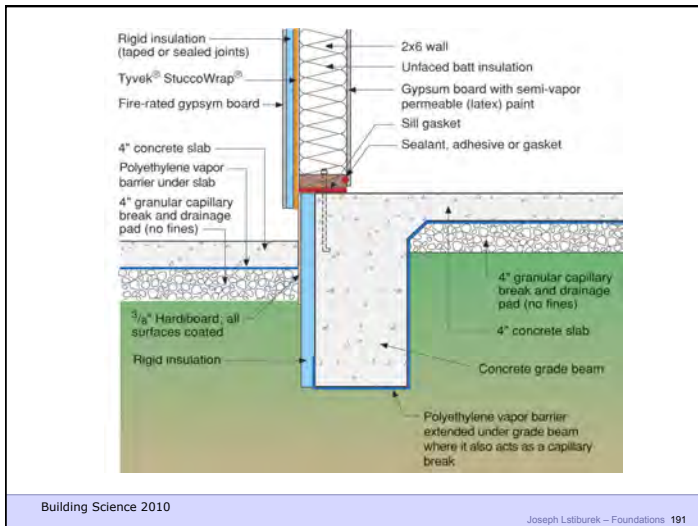

Building Science 2010

Joseph Lstiburek – Foundations 191



Building Science 2010

Joseph Lstiburek – Foundations 192



Building Science 2010

Joseph Lstiburek - Foundations 193

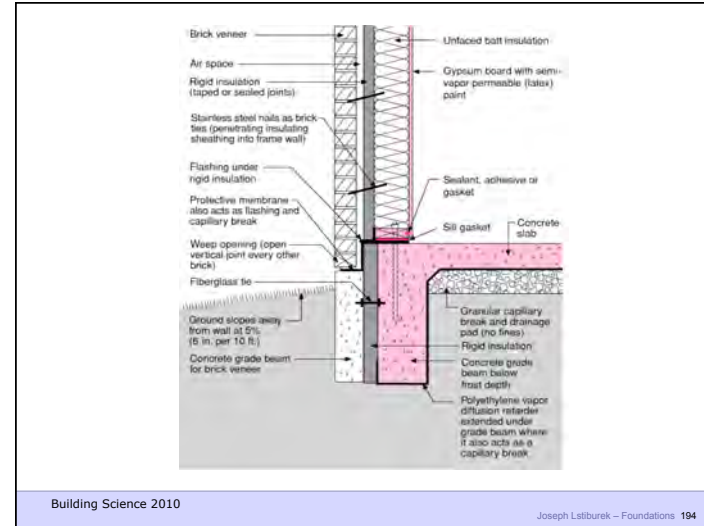

Building Science 2010

Joseph Lstiburek - Foundations 194

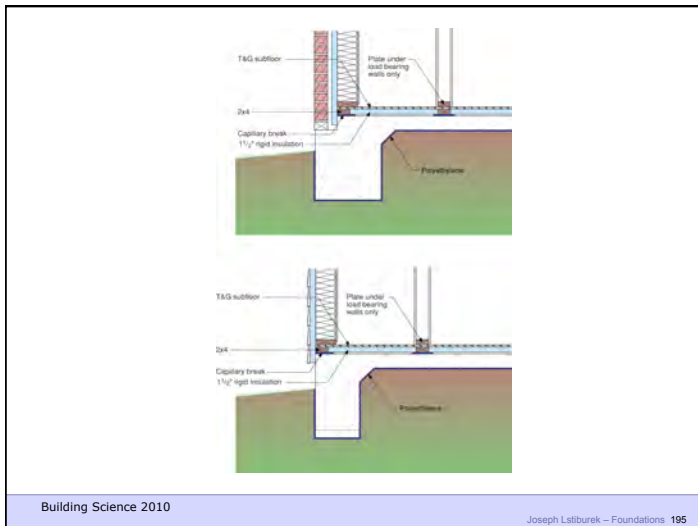

Building Science 2010

Joseph Lstiburek - Foundations 195