

Joseph Lstiburek, Ph.D., P.Eng, ASHRAE Fellow

Building Science

Don't Do Stupid Things

www.buildingscience.com

Life is Tough Enough As it Is...

Building Science Corporation

Joseph Lstiburek 2

Life is Tough Enough As it Is...
It's Harder When You Are Stupid

Building Science Corporation

Joseph Lstiburek 3

Don't Do Stupid Things

Building Science Corporation

Joseph Lstiburek 4

What is a Building?

Building Science Corporation Joseph Lstiburek 5

A Building is an Environmental Separator

Building Science Corporation Joseph Lstiburek 6

2nd Law of Thermodynamics

Building Science Corporation Joseph Lstiburek 7

In an isolated system, a process can occur only if it increases the total entropy of the system

Rudolf Clausius

Building Science Corporation Joseph Lstiburek 8

Heat Flow Is From Warm To Cold
Moisture Flow Is From Warm To Cold
Moisture Flow Is From More To Less
Air Flow Is From A Higher Pressure to a
Lower Pressure
Gravity Acts Down

Building Science Corporation Joseph Lstiburek 9

Moisture Flow Is From Warm To Cold
Moisture Flow Is From More To Less

Building Science Corporation Joseph Lstiburek 10

Moisture Flow Is From Warm To Cold
Moisture Flow Is From More To Less

Thermal Gradient – Thermal Diffusion
Concentration Gradient – Molecular Diffusion

Building Science Corporation Joseph Lstiburek 11

Moisture Flow Is From Warm To Cold
Moisture Flow Is From More To Less

Thermal Gradient – Thermal Diffusion
Concentration Gradient – Molecular Diffusion

Vapor Diffusion

Building Science Corporation Joseph Lstiburek 12

Thermodynamic Potential

Building Science Corporation Joseph Lstiburek 13

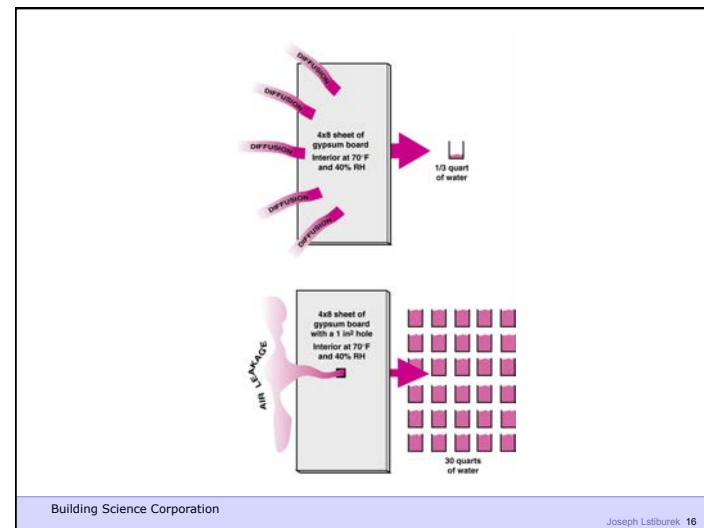
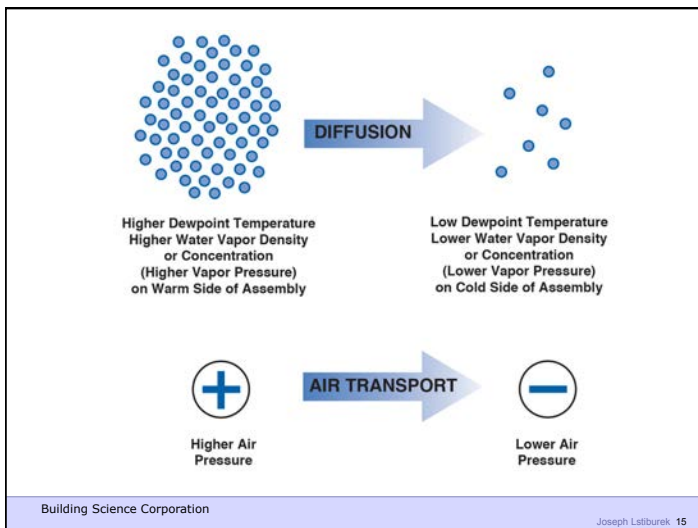
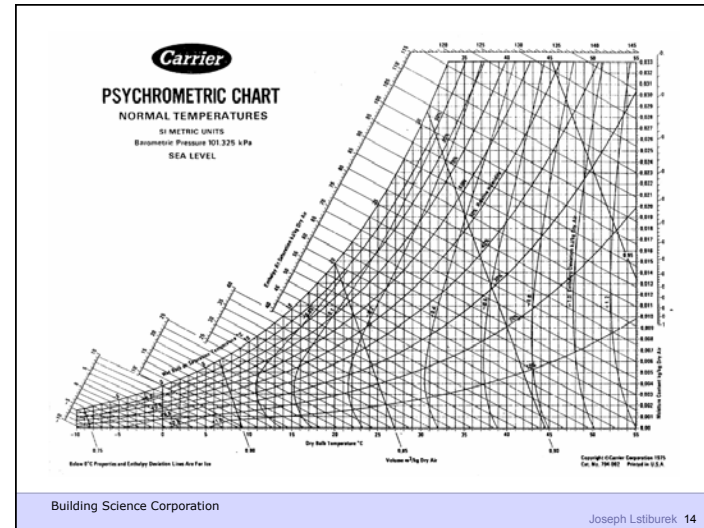

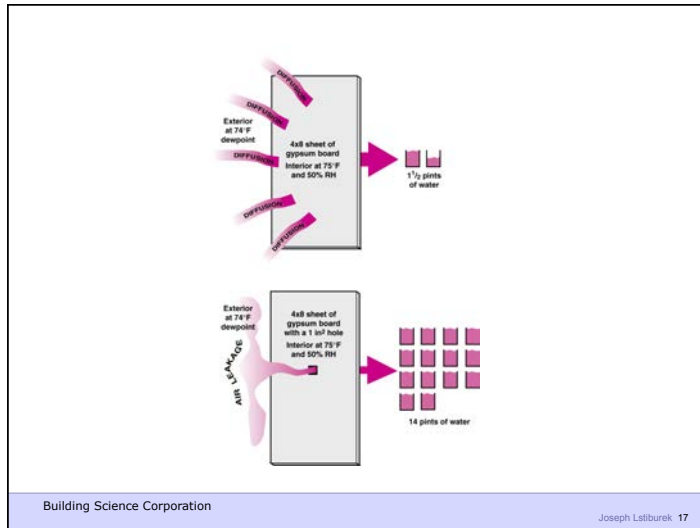

Damage Functions

Building Science Corporation Joseph Lstiburek 18

Damage Functions
Water
Heat
Ultra Violet Radiation

Building Science Corporation Joseph Lstiburek 19

Damage Functions
Water
Heat
Ultra Violet Radiation
Oxidization (Ozone)
Fatigue (Creep)

Building Science Corporation Joseph Lstiburek 20

The Three Biggest Problems In Buildings Are
Water, Water and Water...

Building Science Corporation Joseph Lstiburek 21

80 Percent of all Construction Problems are
Related to Water

Building Science Corporation Joseph Lstiburek 22

Heat
Air
Moisture

Building Science Corporation Joseph Lstiburek 23

HAM

Building Science Corporation Joseph Lstiburek 24

Hygrothermal Analysis

Building Science Corporation Joseph Lstiburek 25

Water Control Layer
Air Control Layer
Vapor Control Layer
Thermal Control Layer

Building Science Corporation Joseph Lstiburek 26

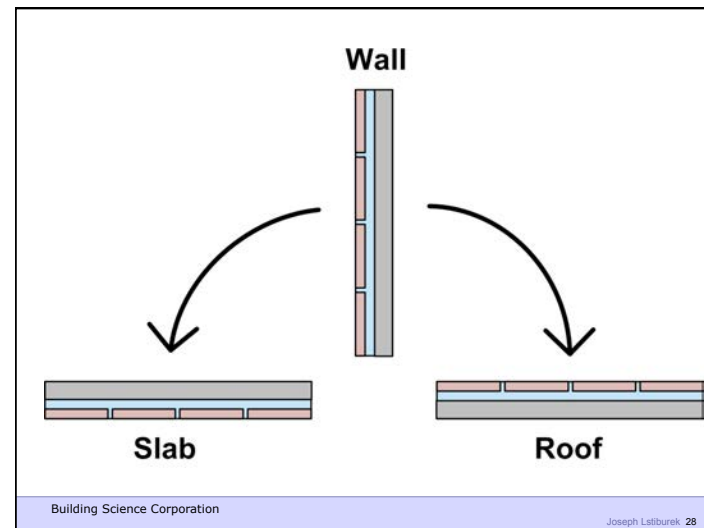
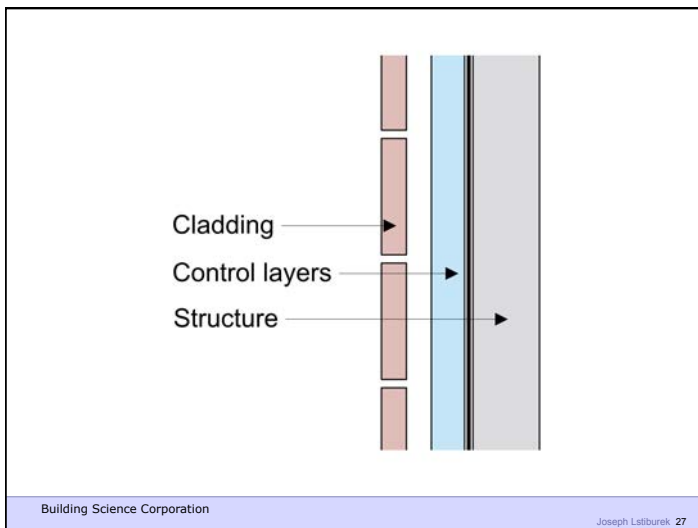

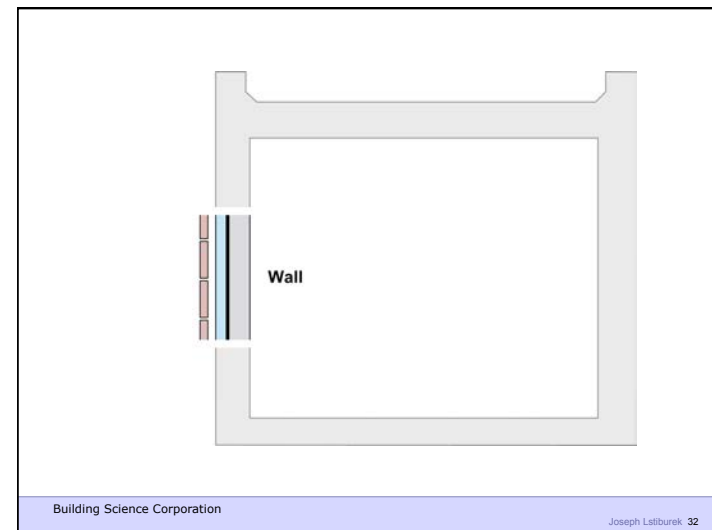
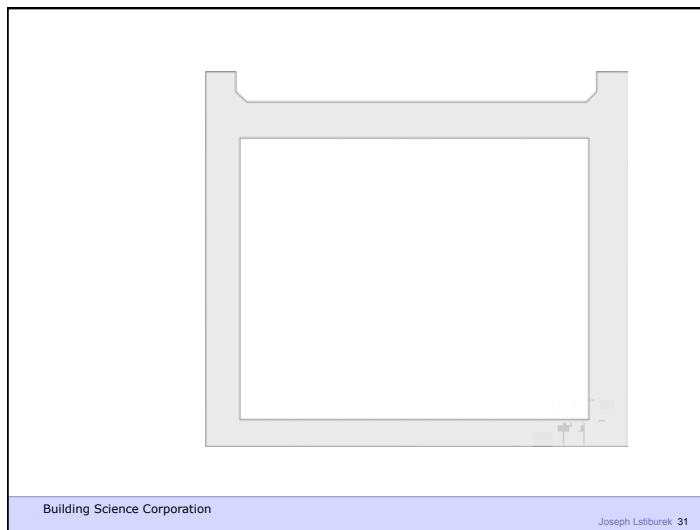
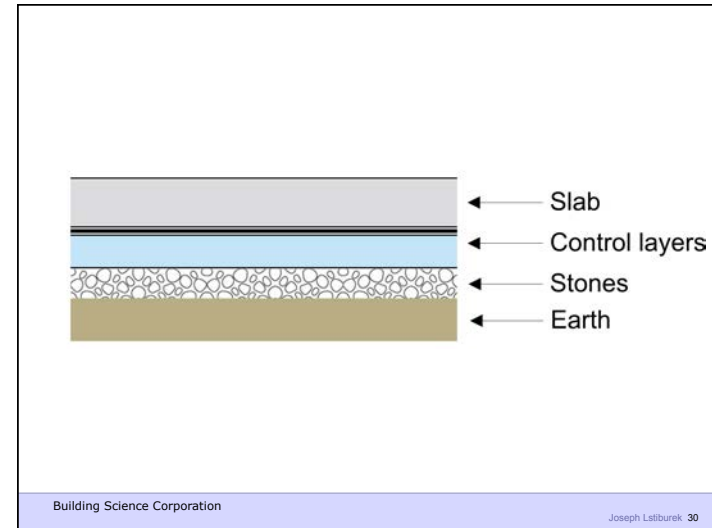
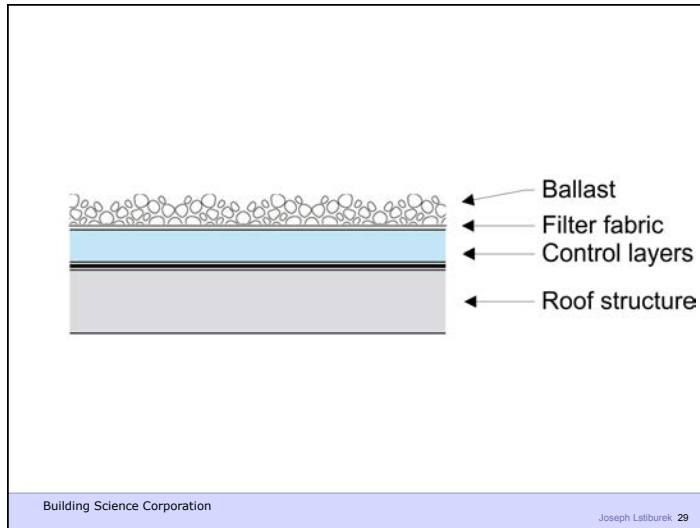

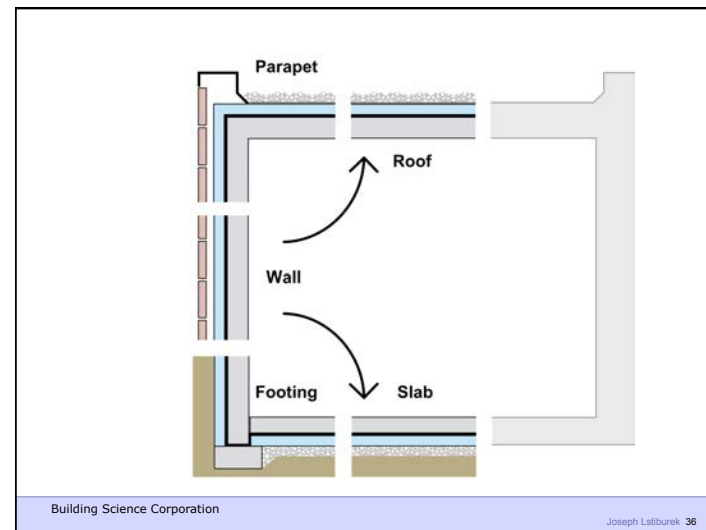
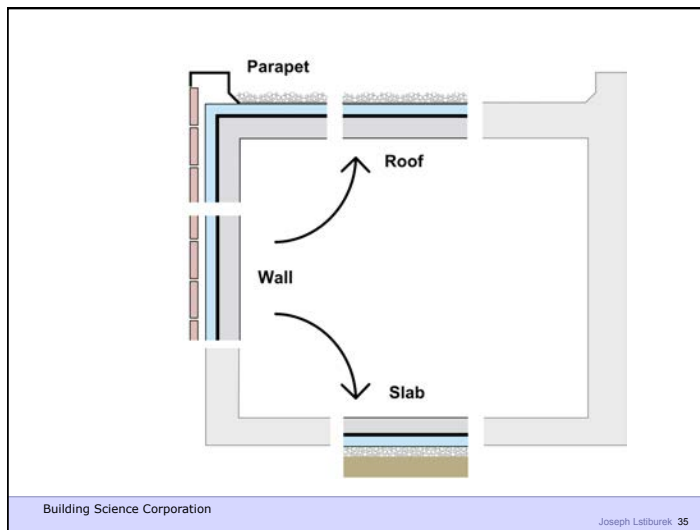
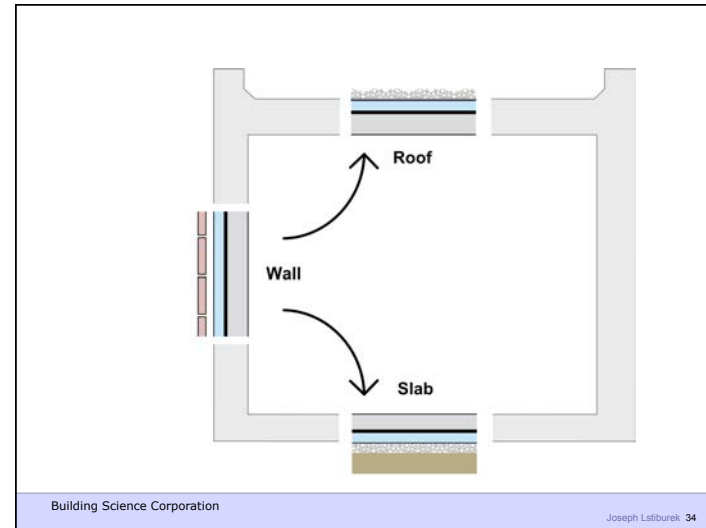
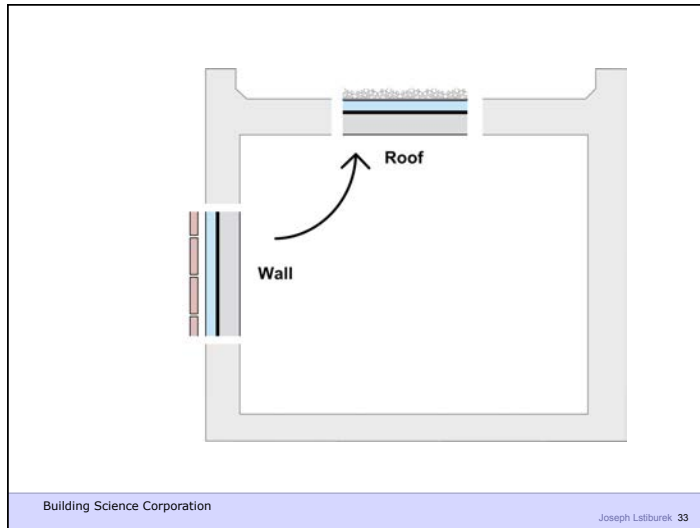

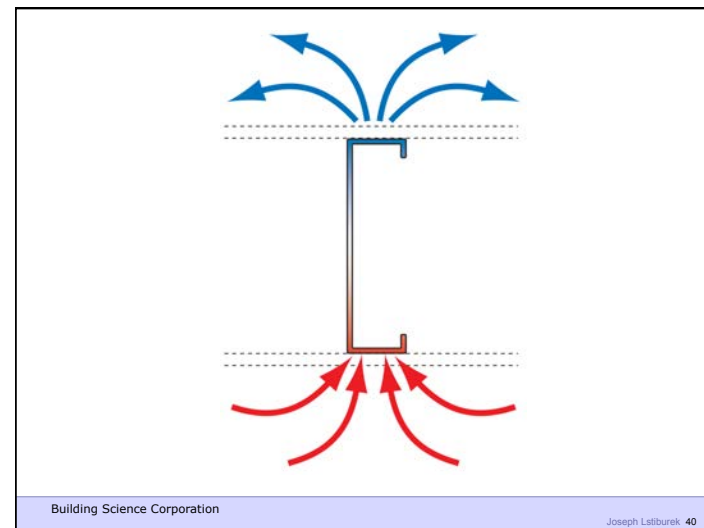
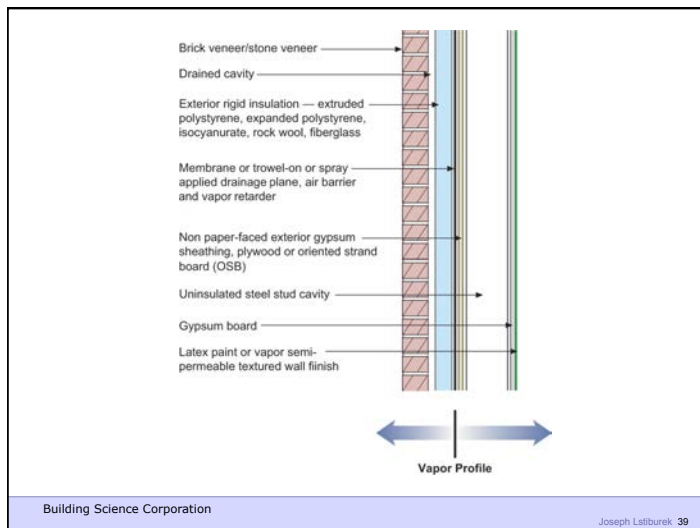
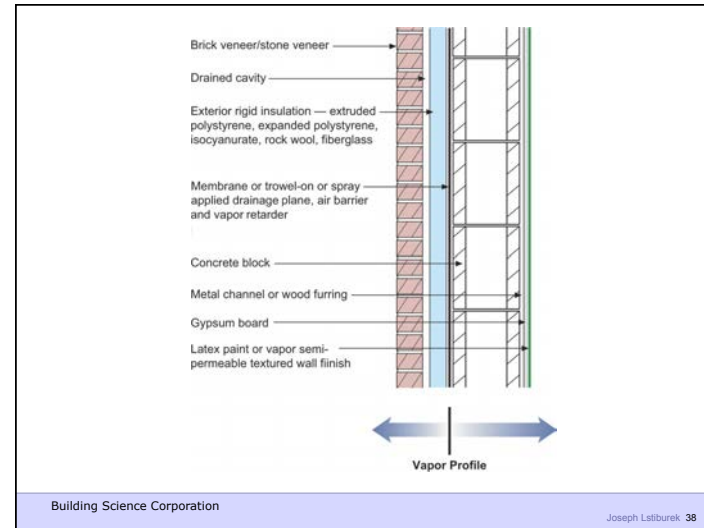
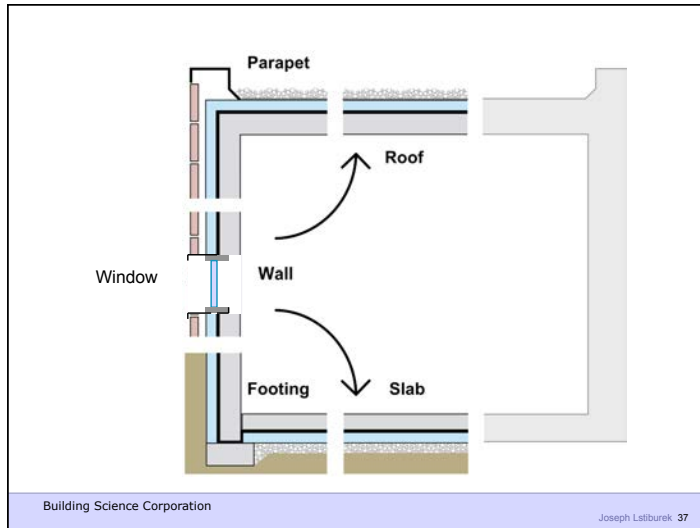

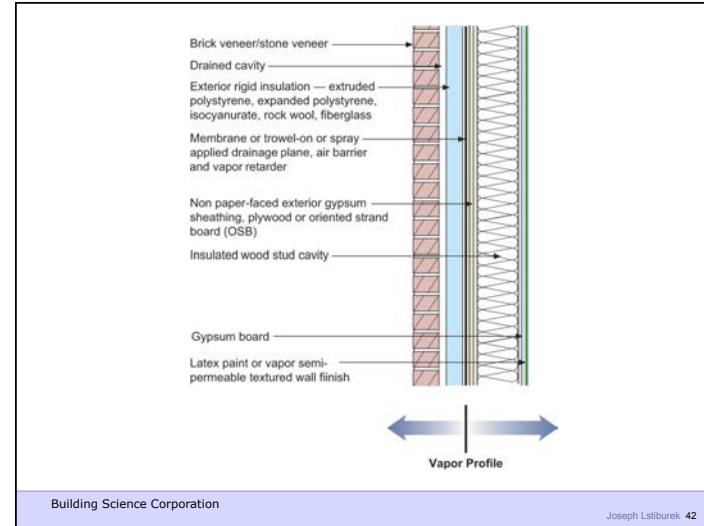

Commercial Enclosure: Simple Layers

- Structure
- Rain/Air/Vapor
- Insulation
- Finish

Building Science Corporation
Joseph Lstiburek 43

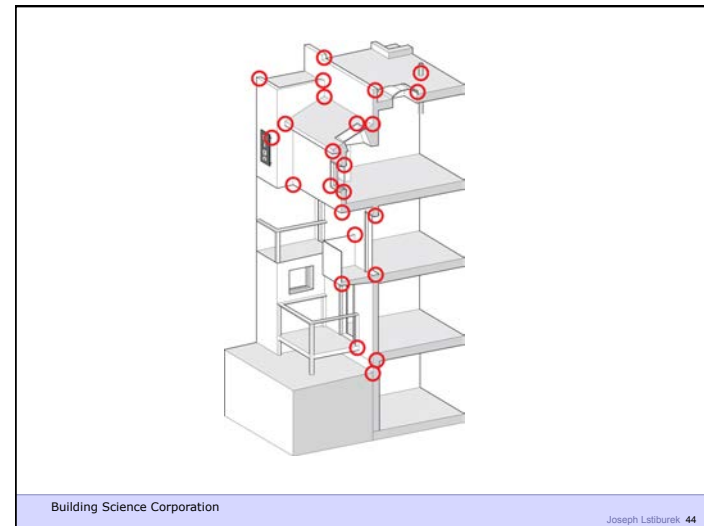

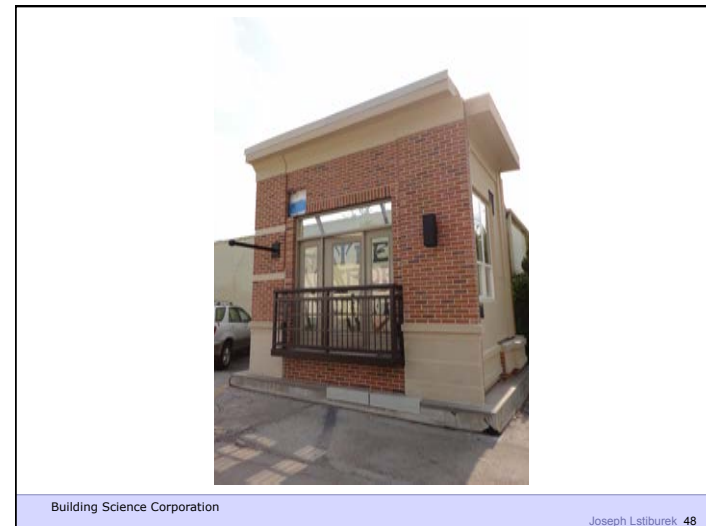

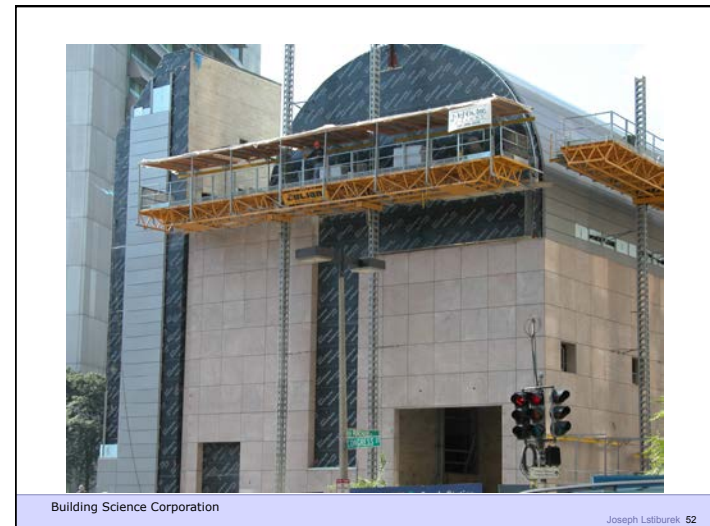
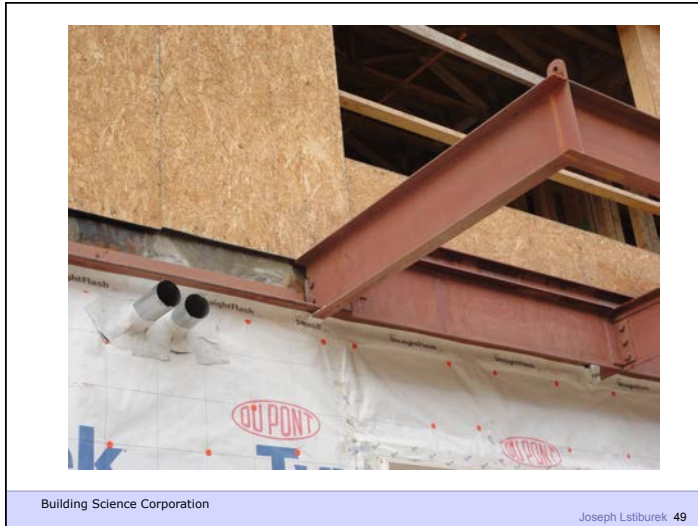

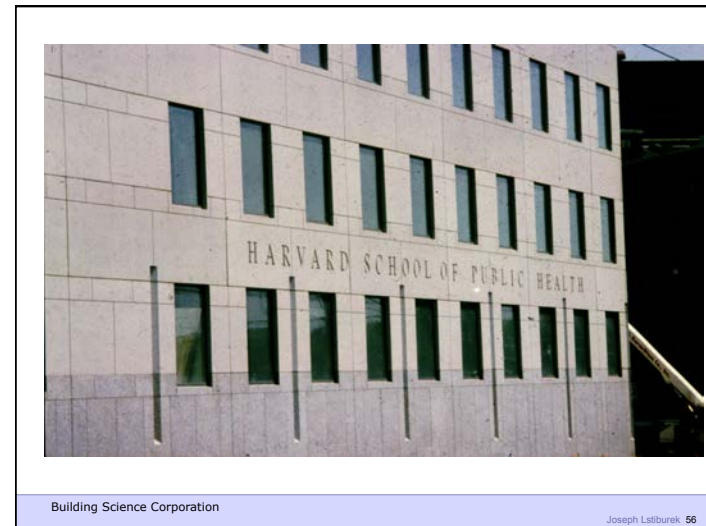
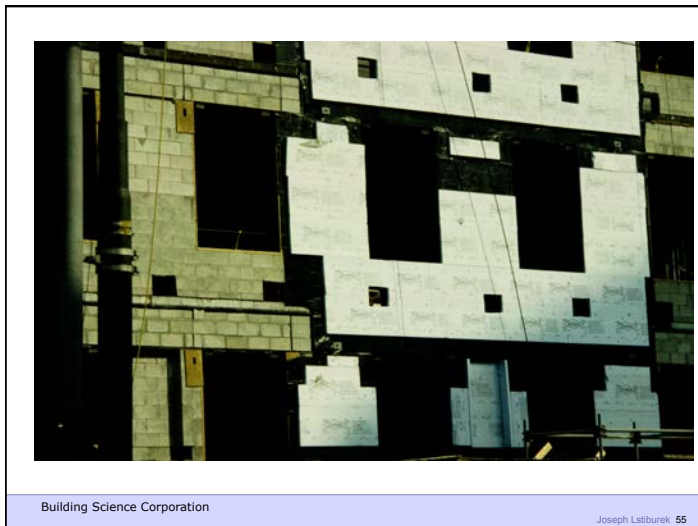
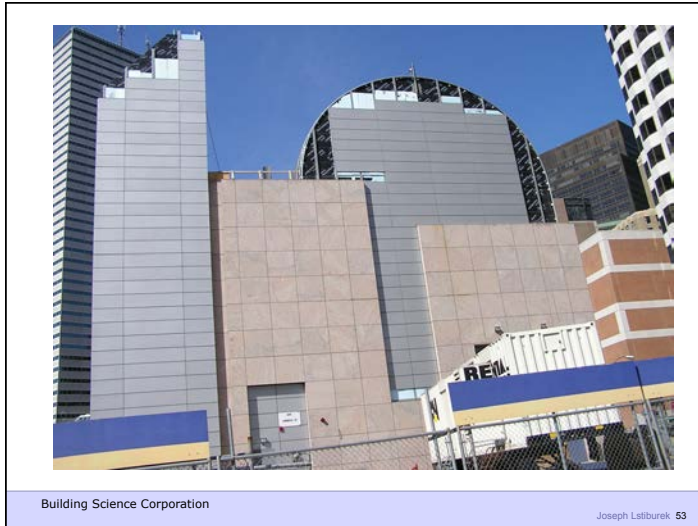

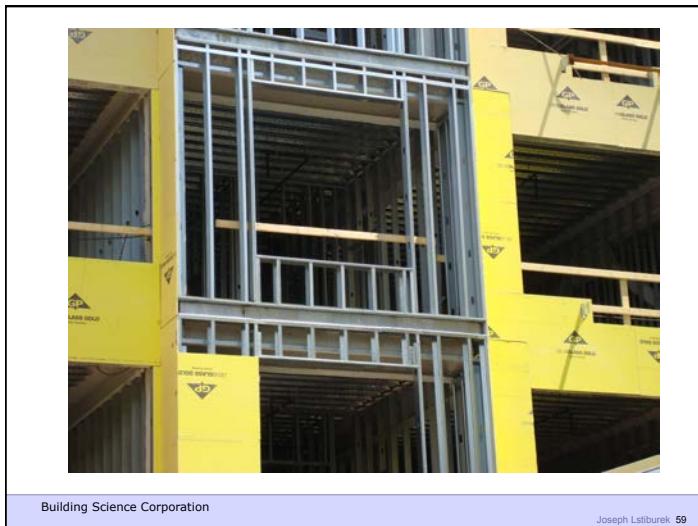

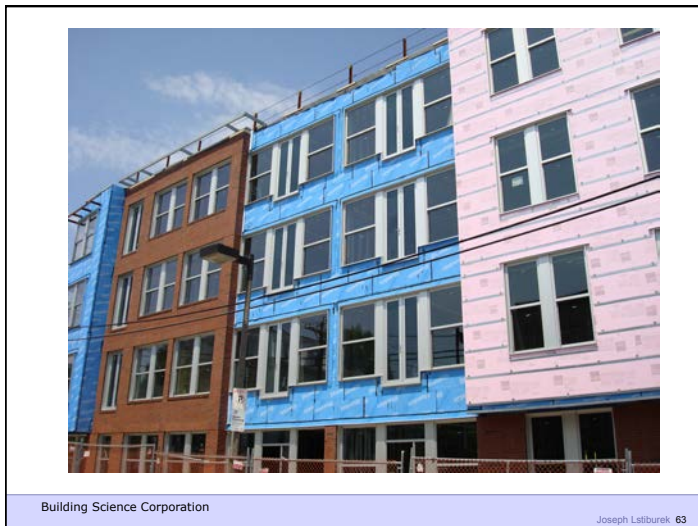



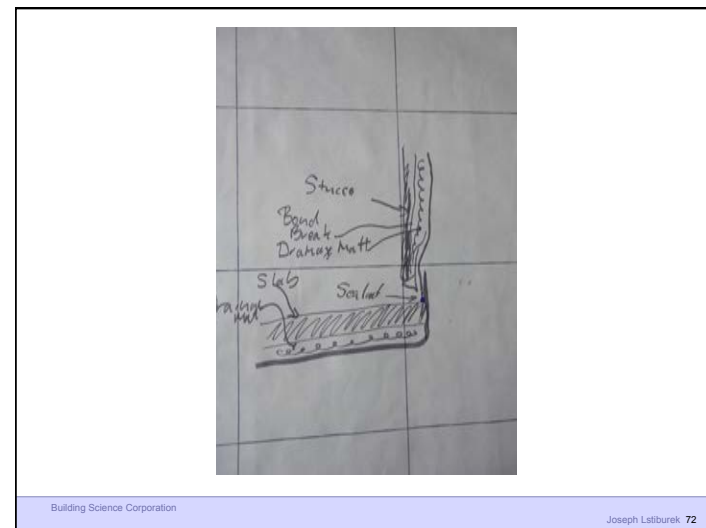

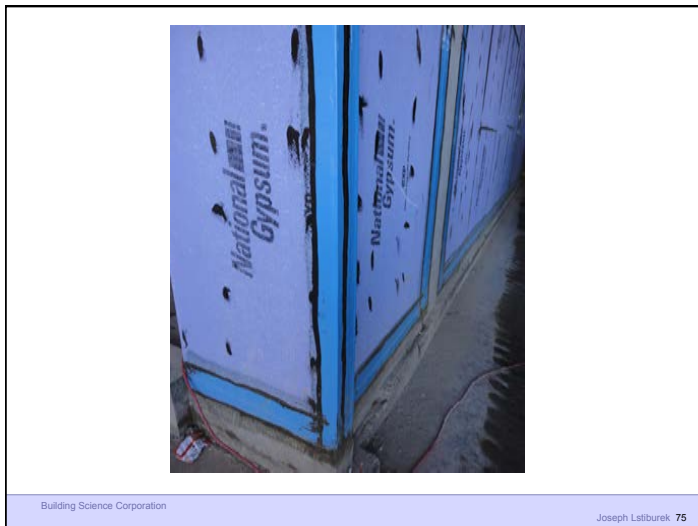



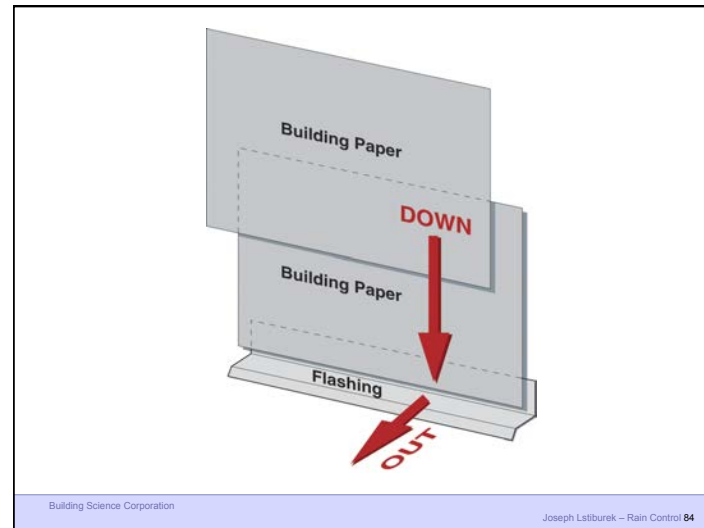
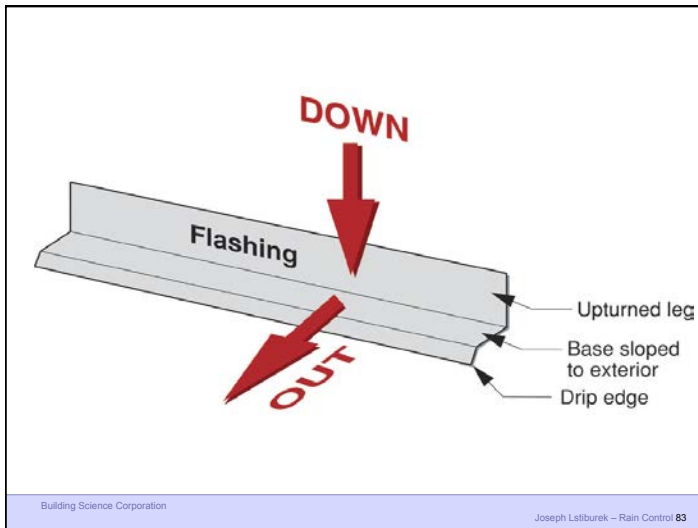
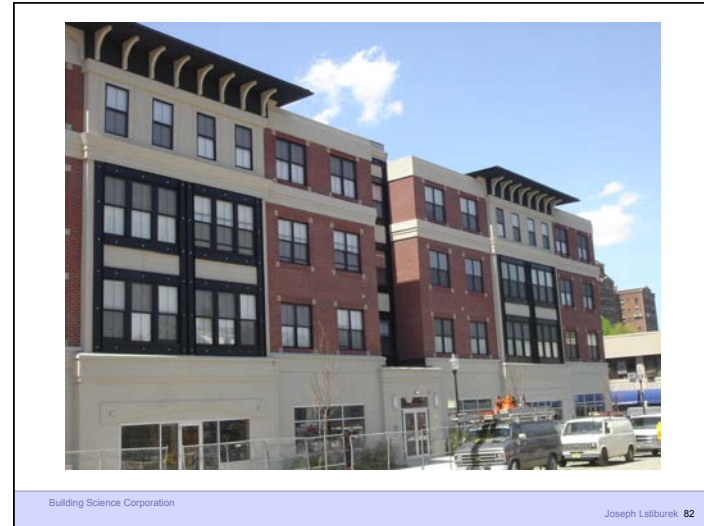
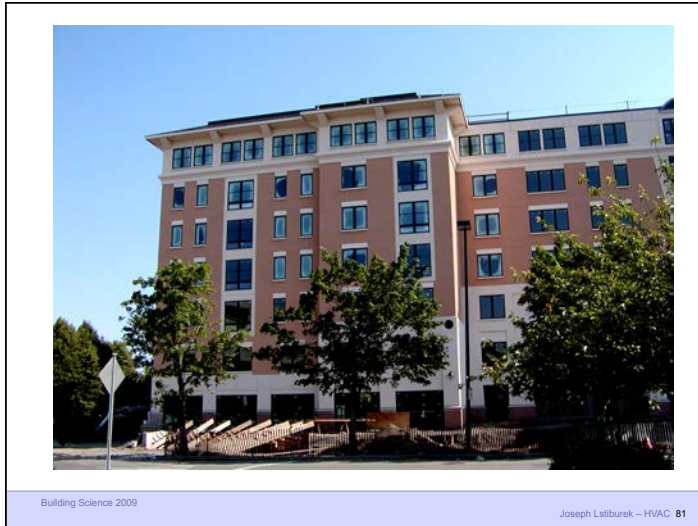

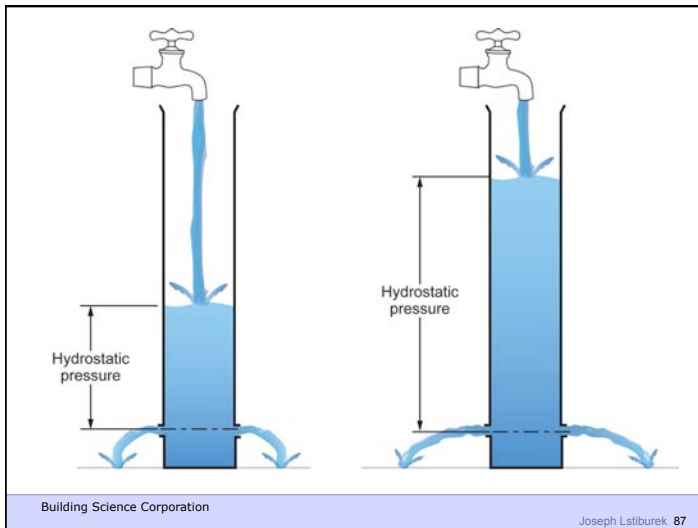

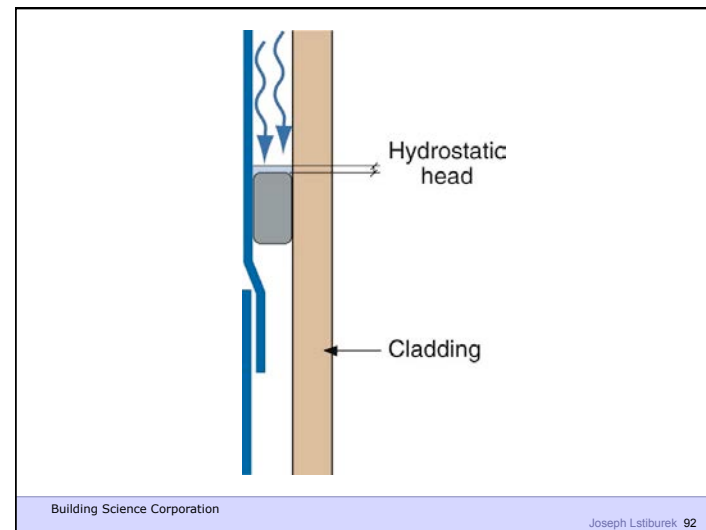
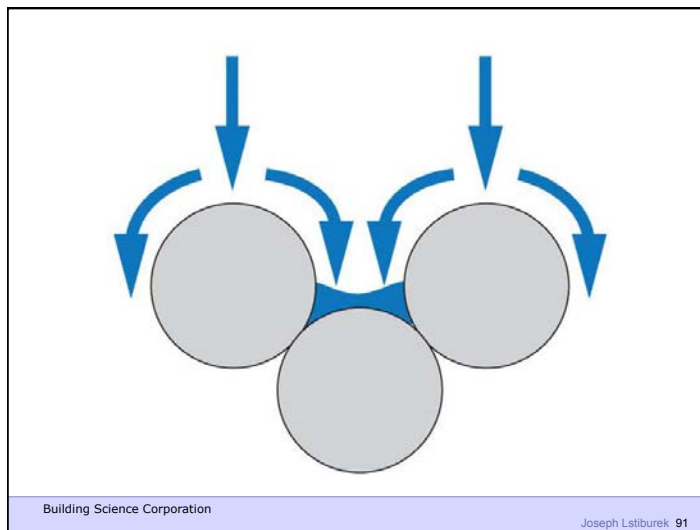
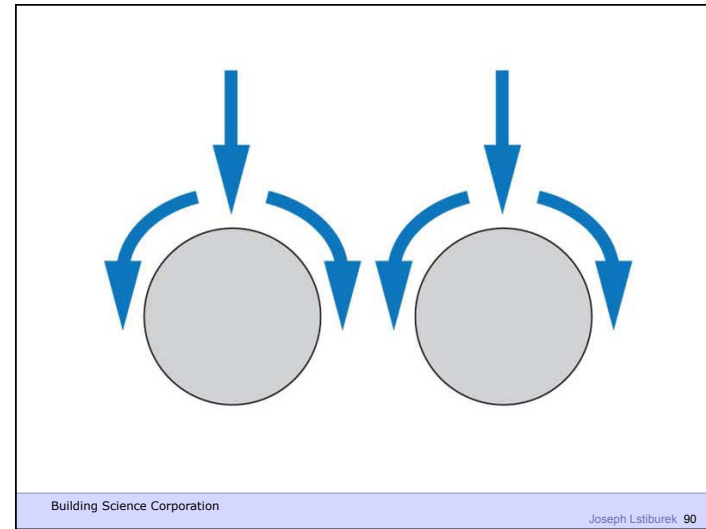
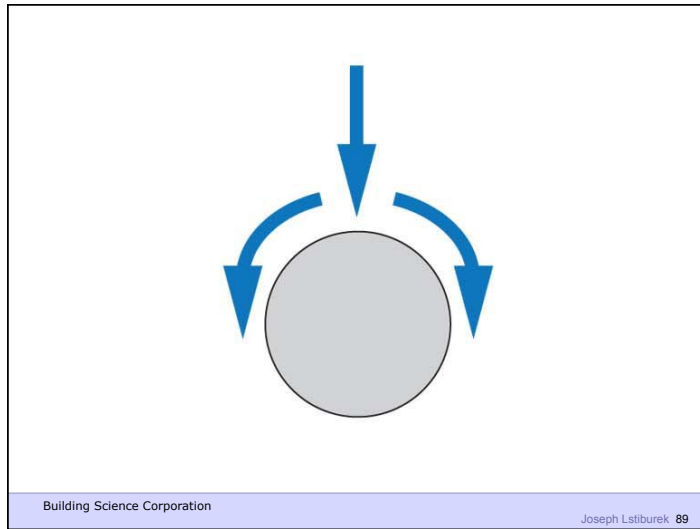

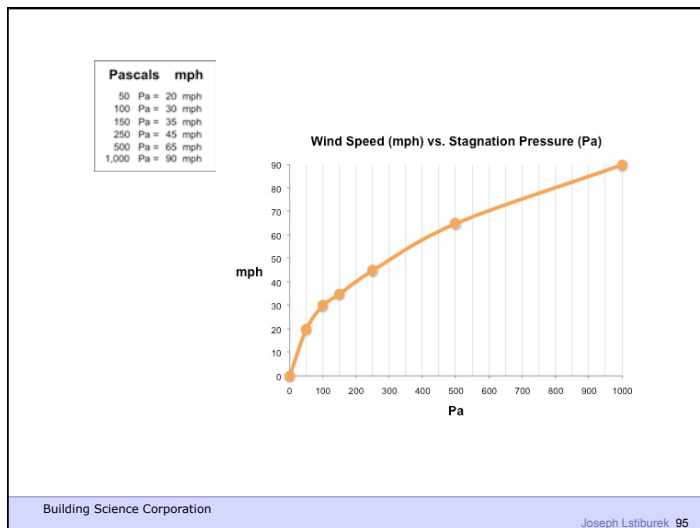
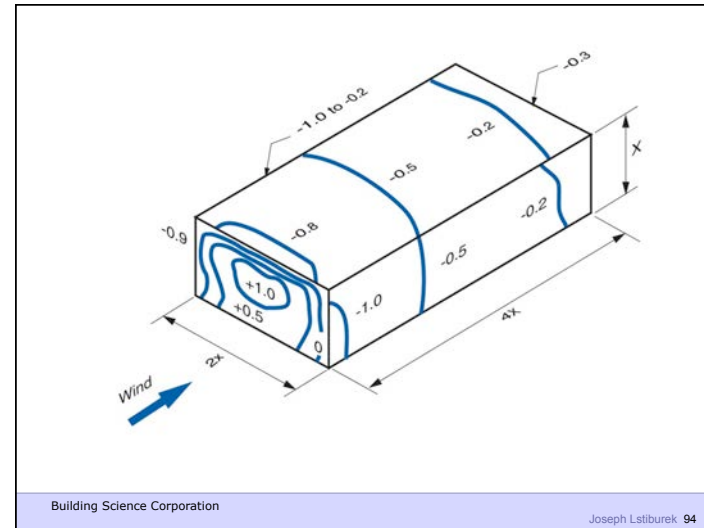
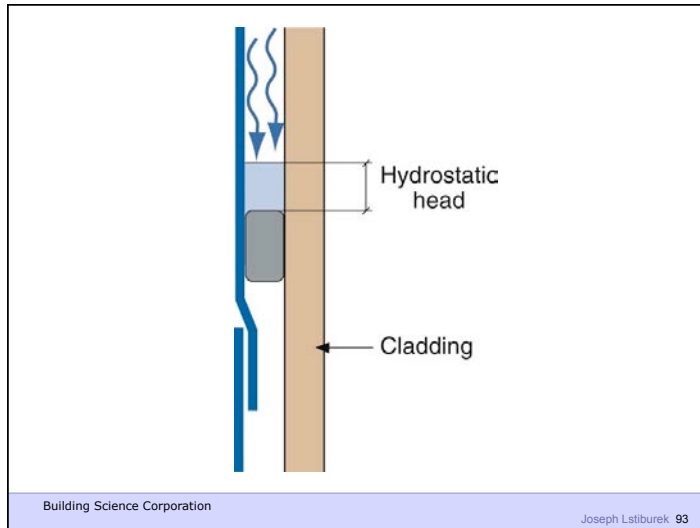

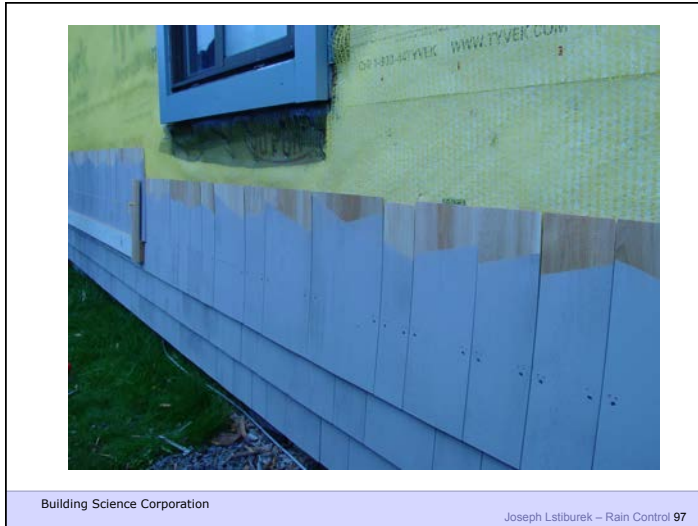

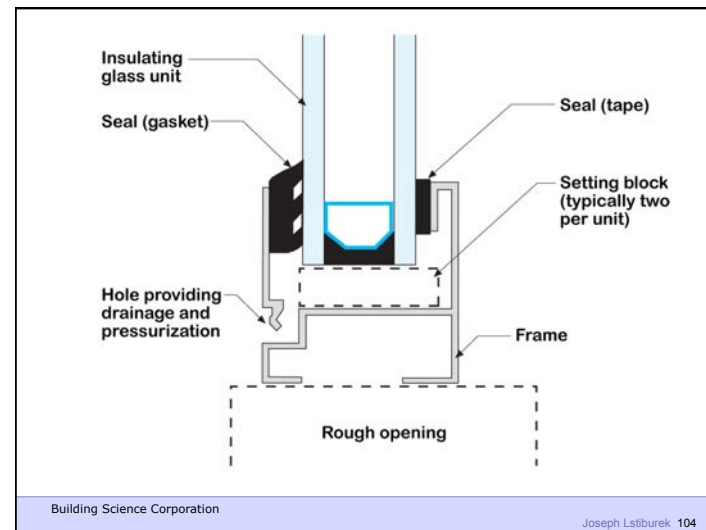
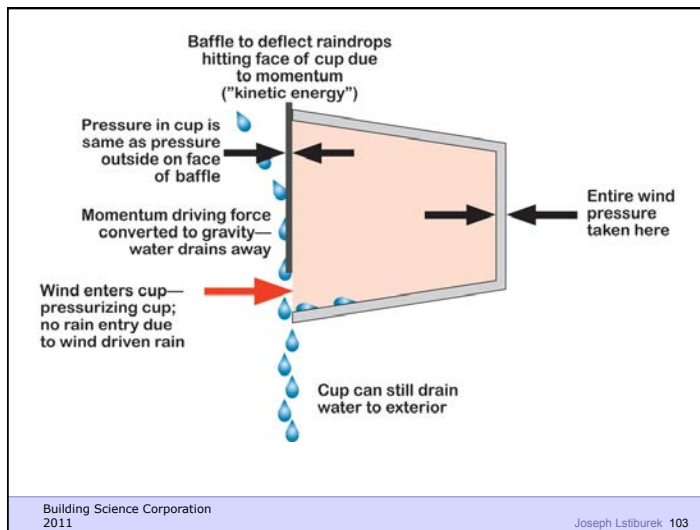
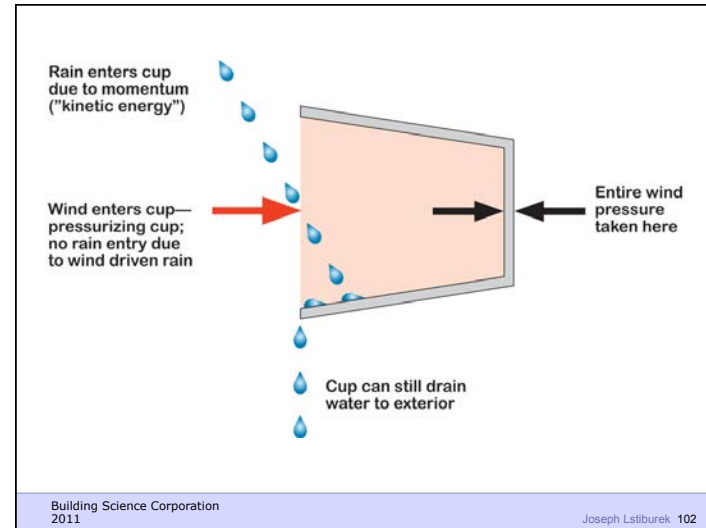
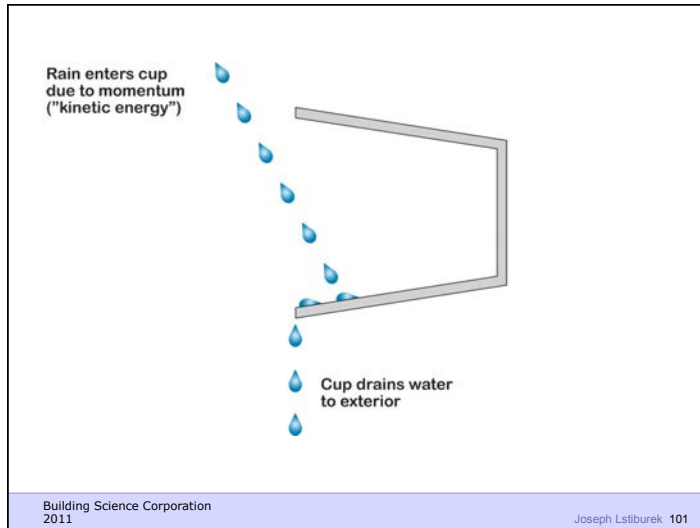

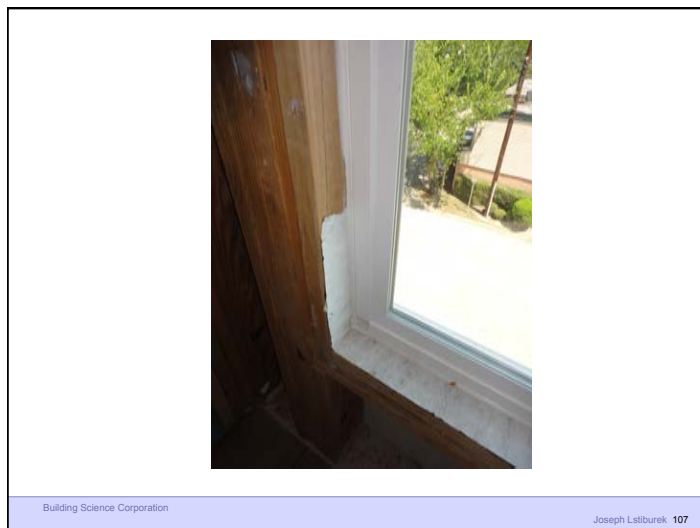
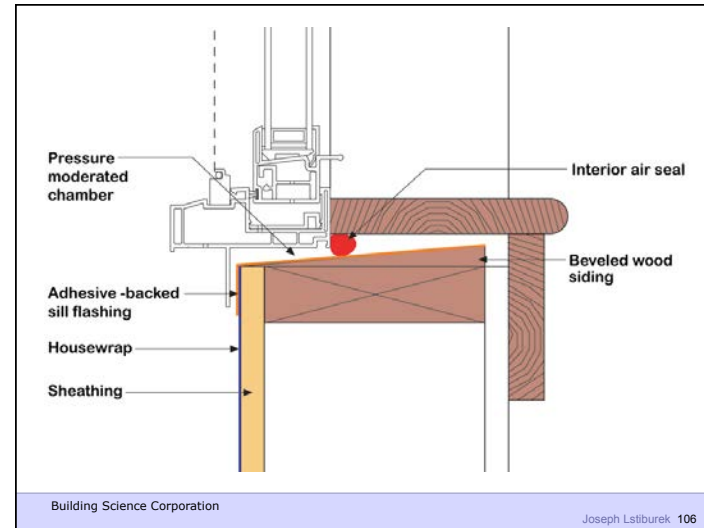
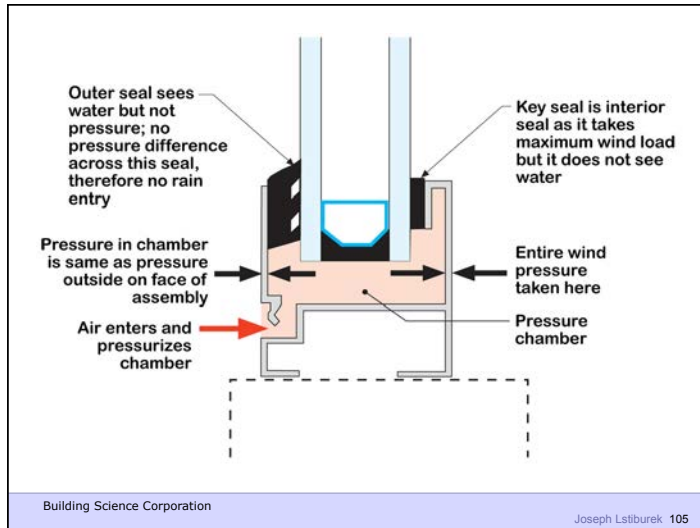

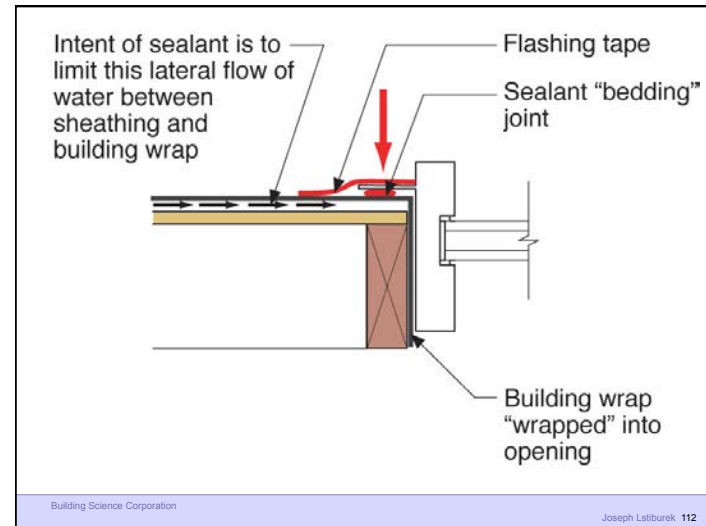
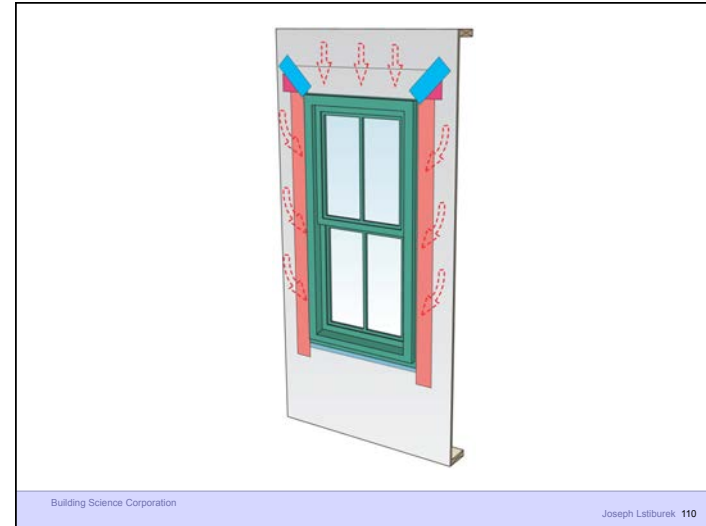

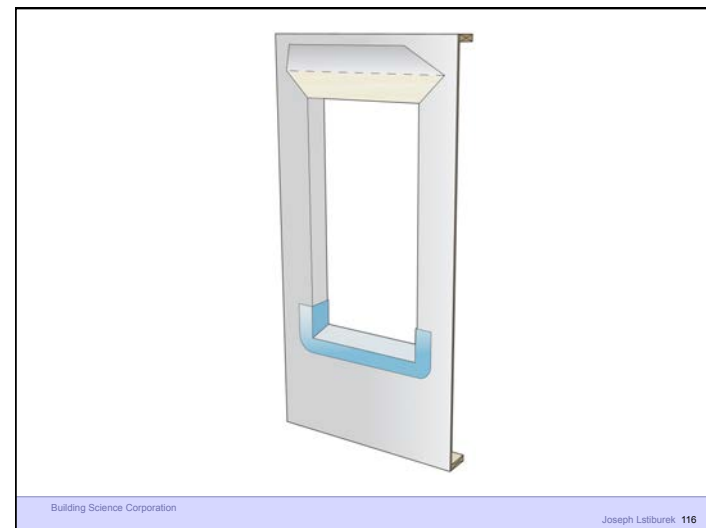
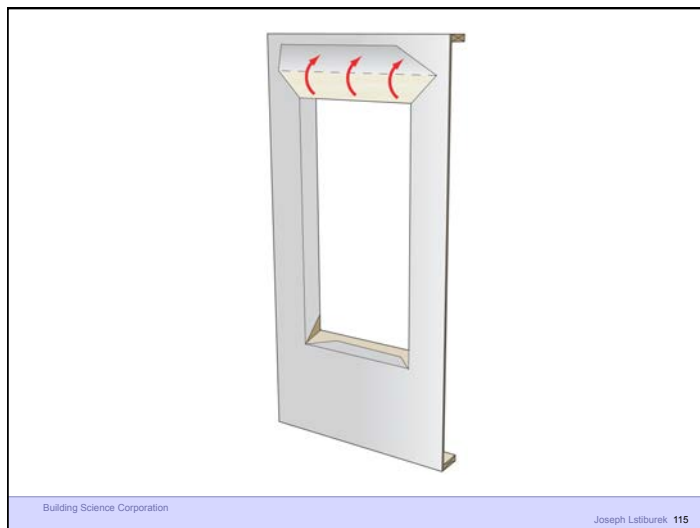
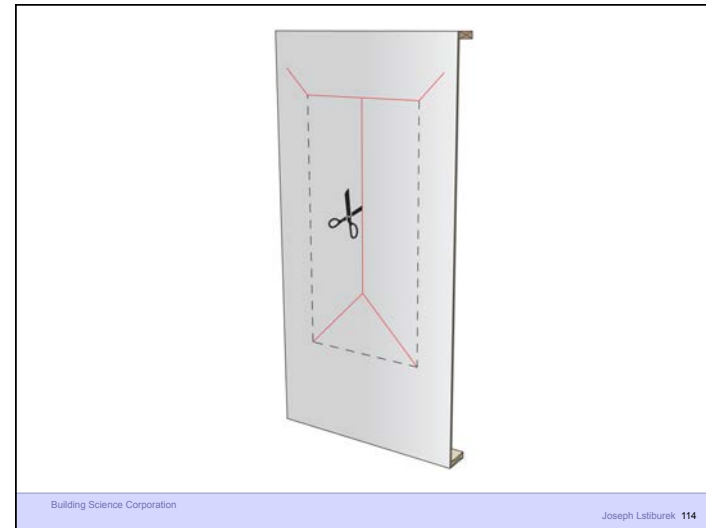
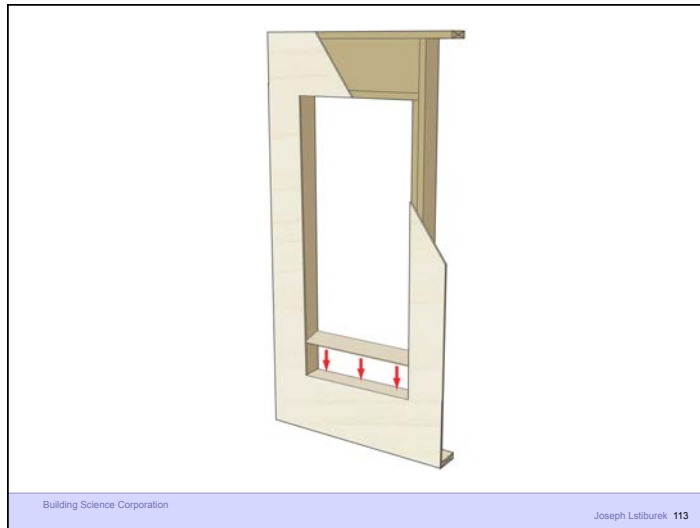

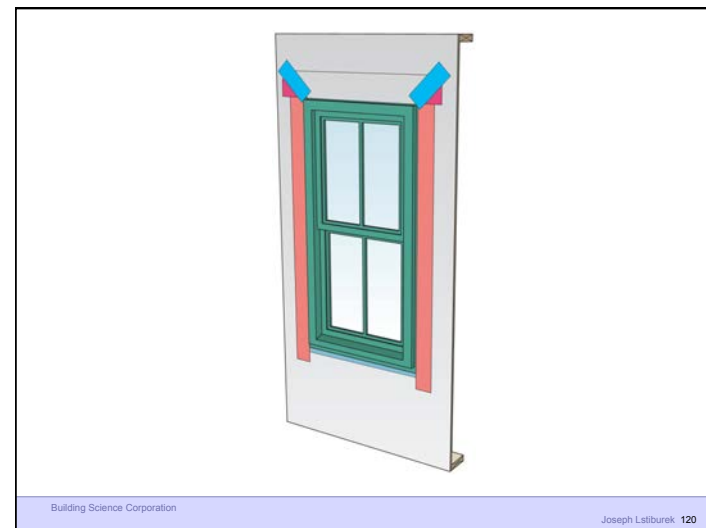
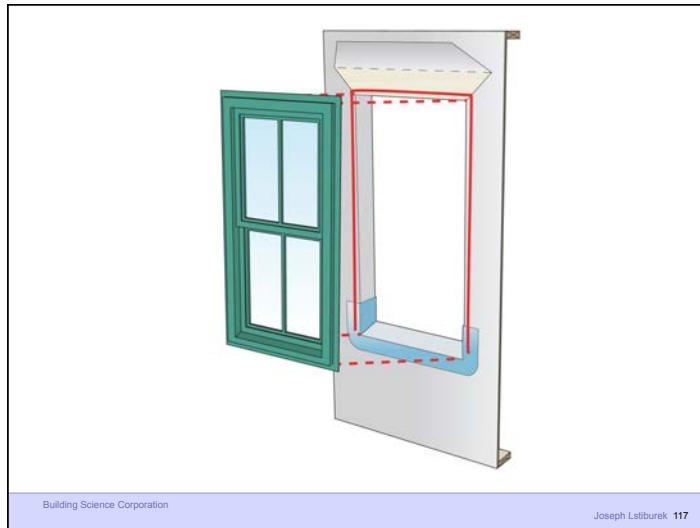

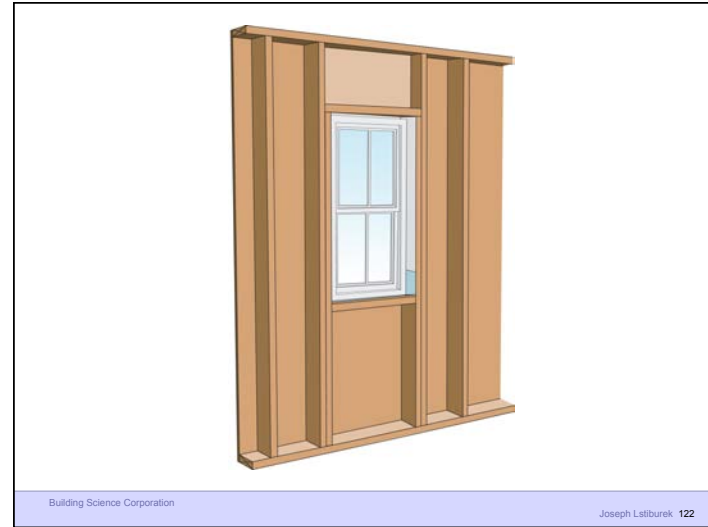
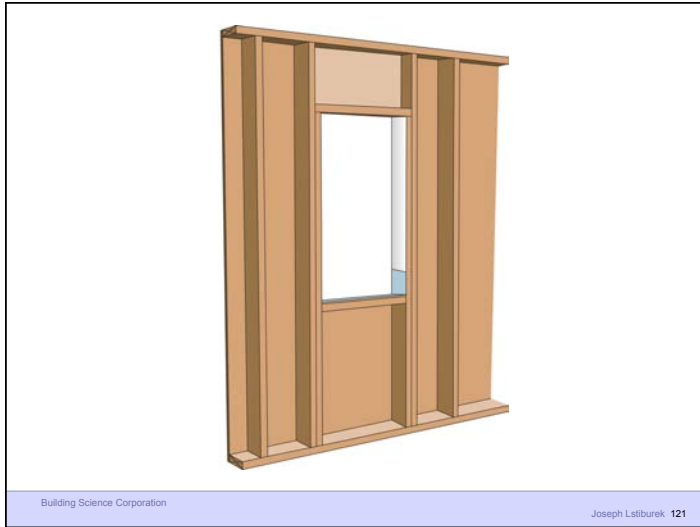

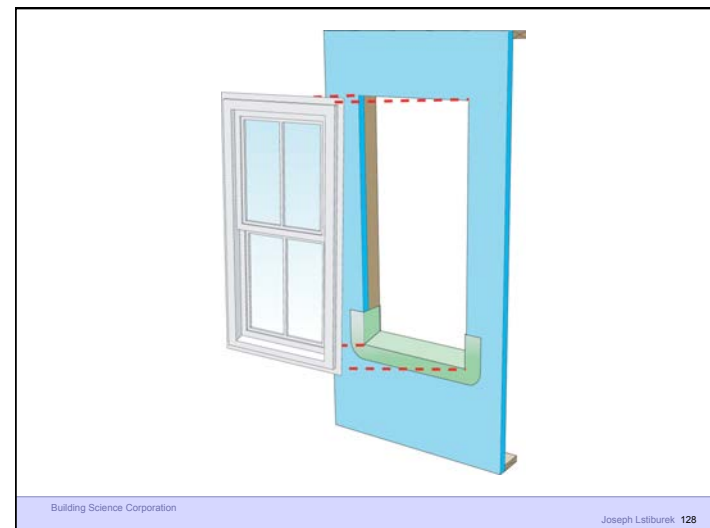
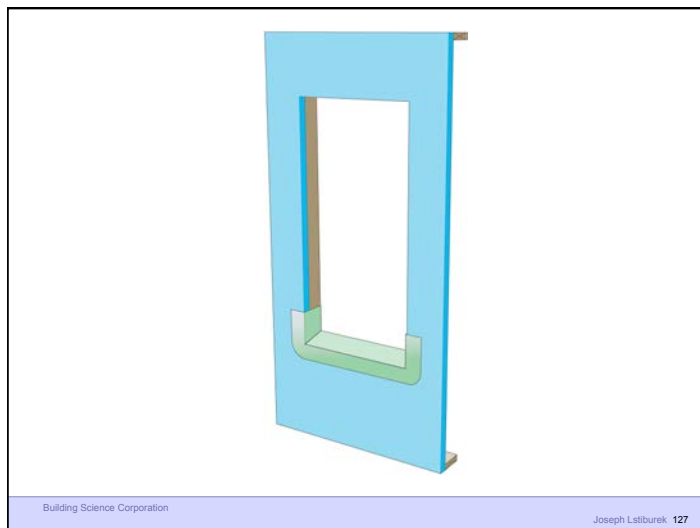
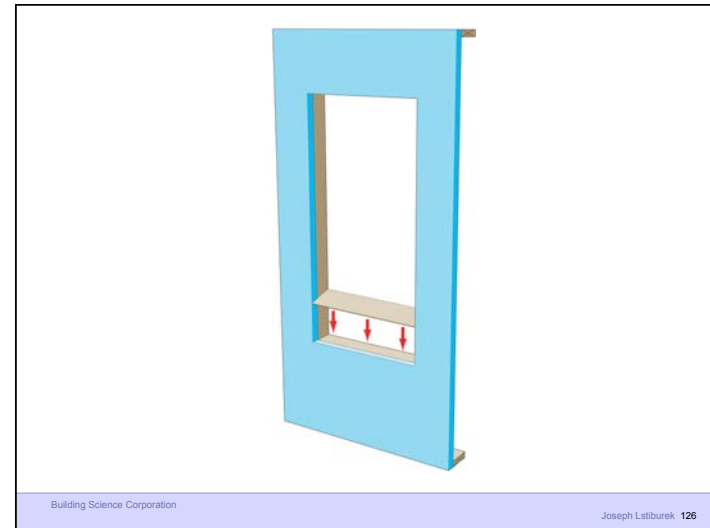
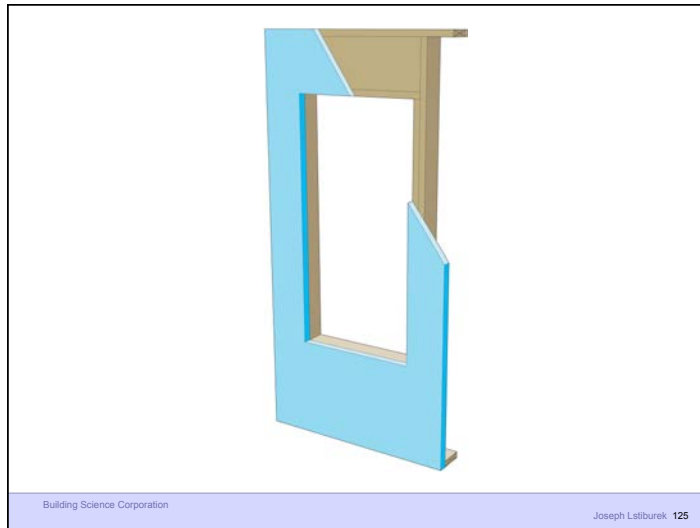



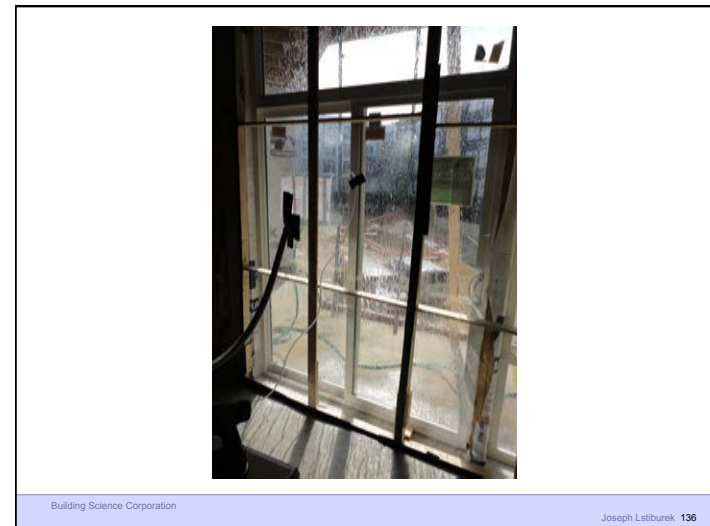

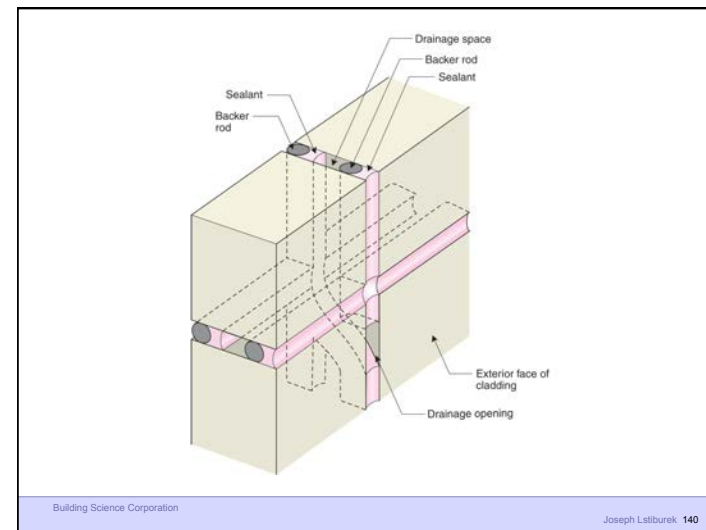
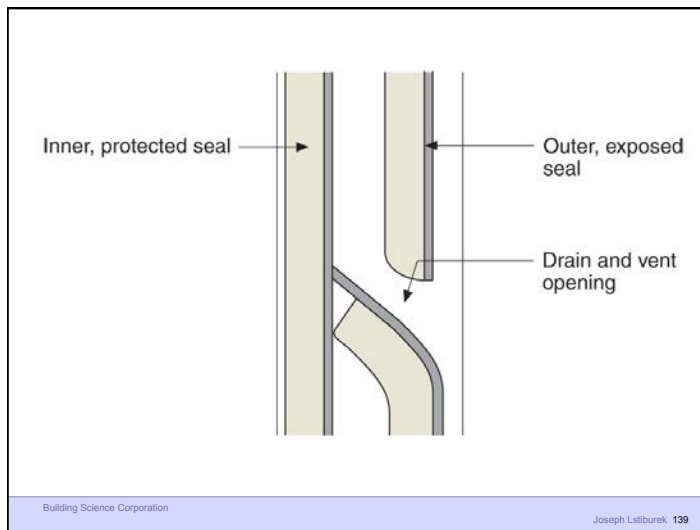
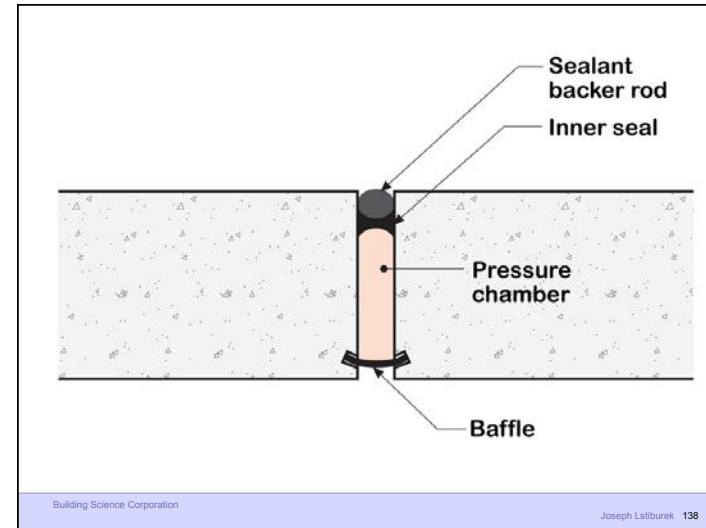
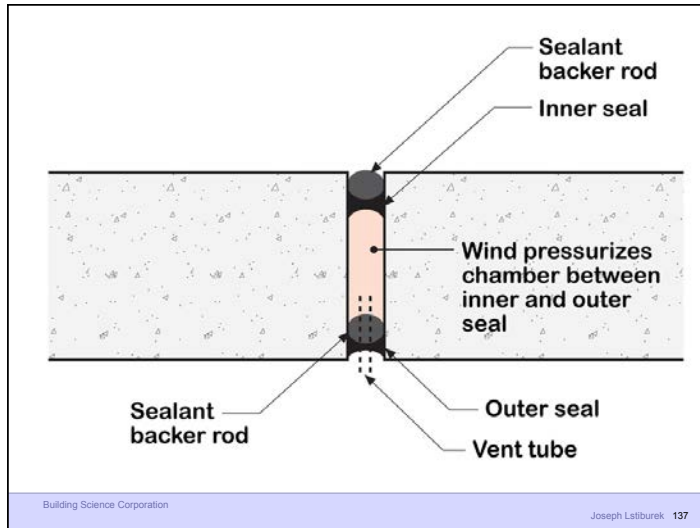

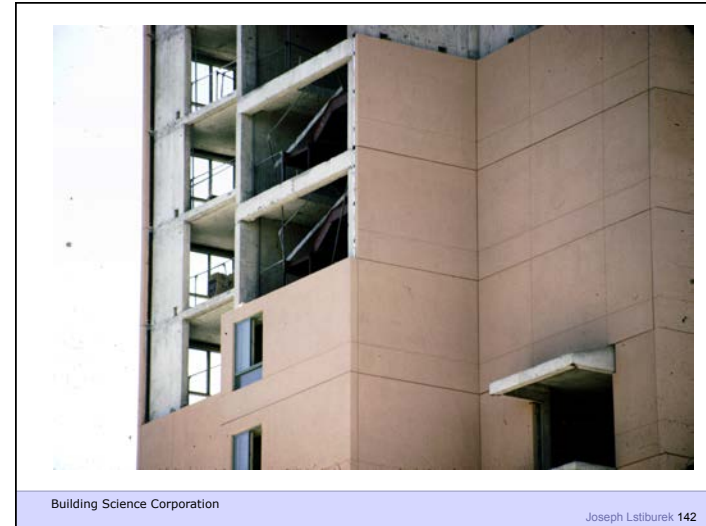

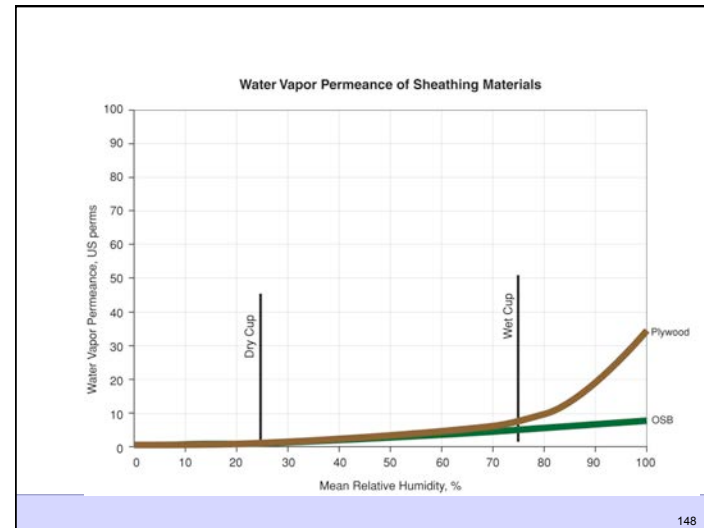
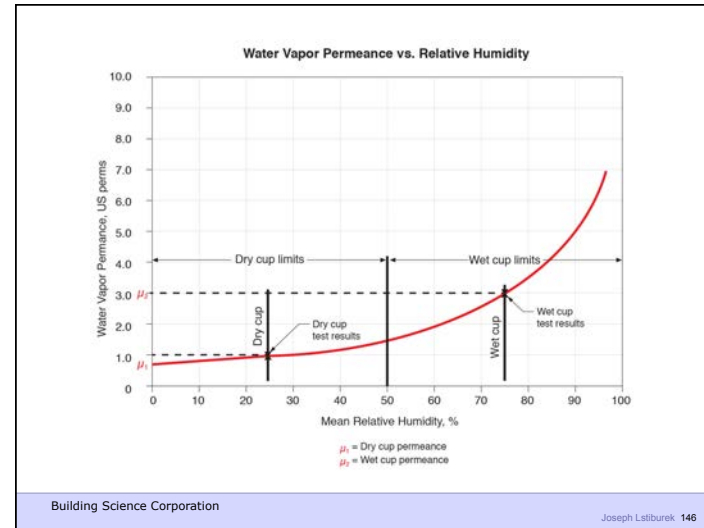
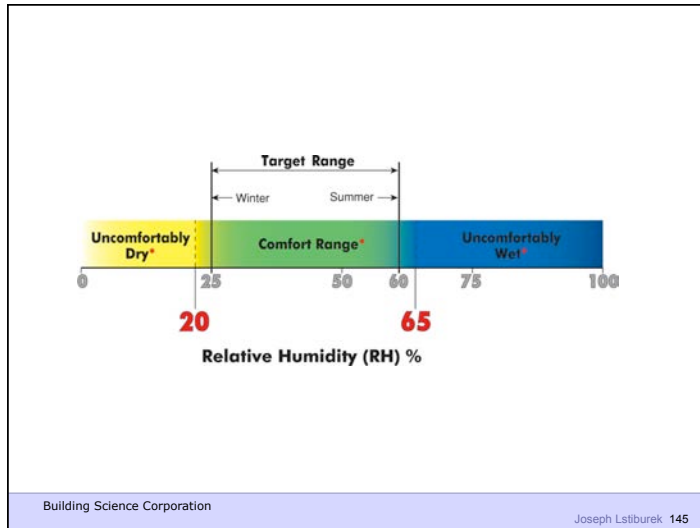

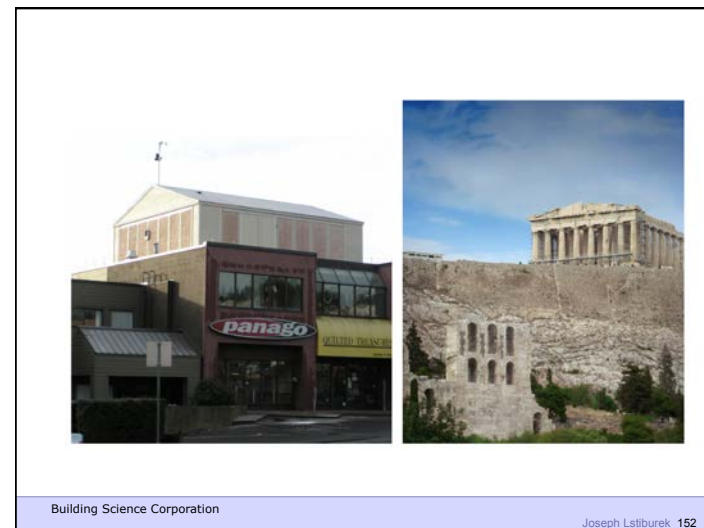
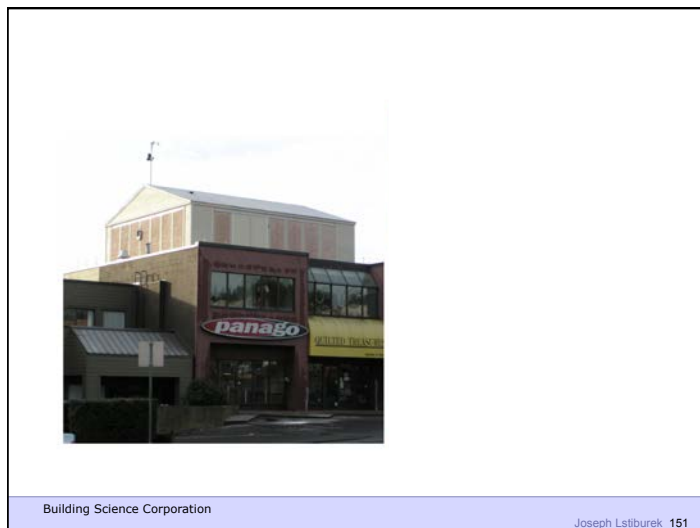
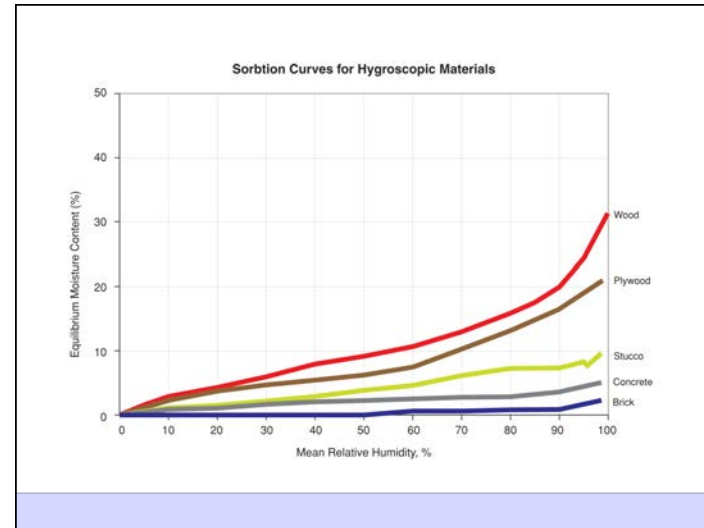
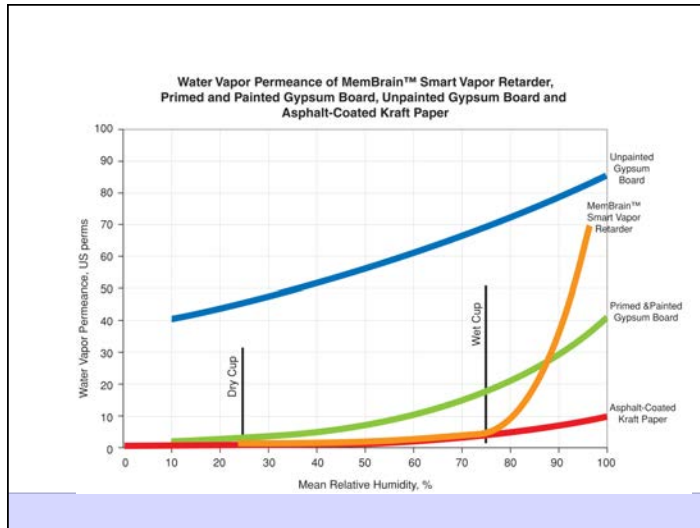

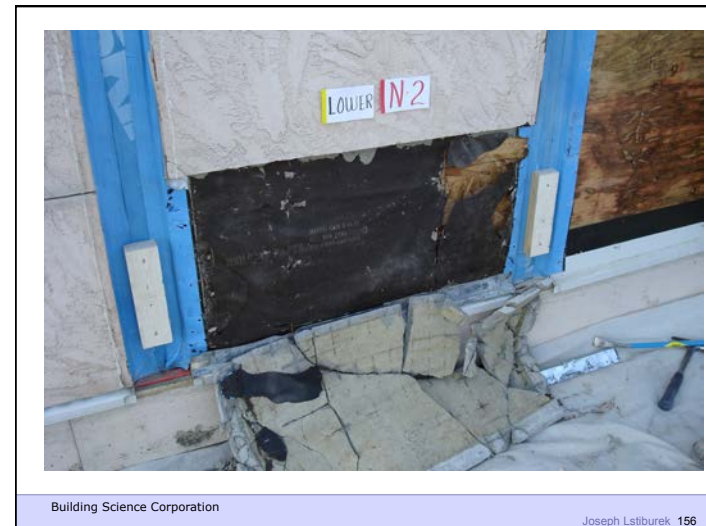

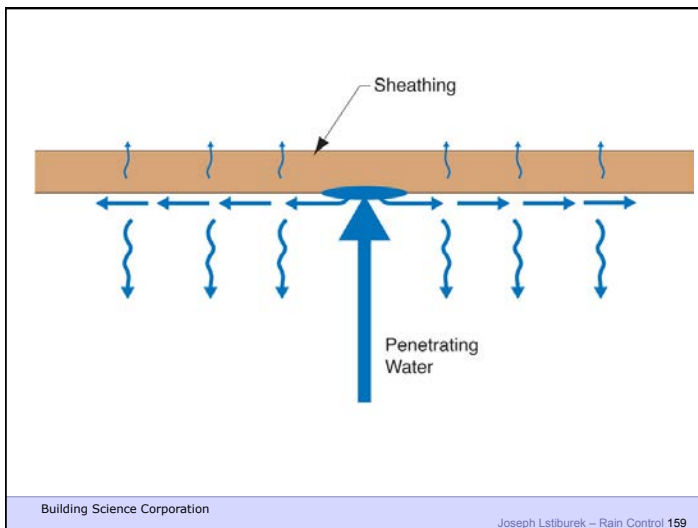
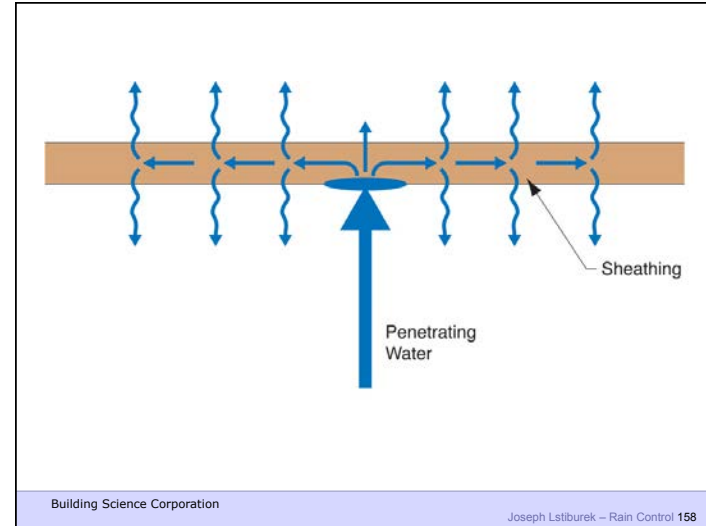

Rain Screen

Building Science Corporation
Joseph Lstiburek 161

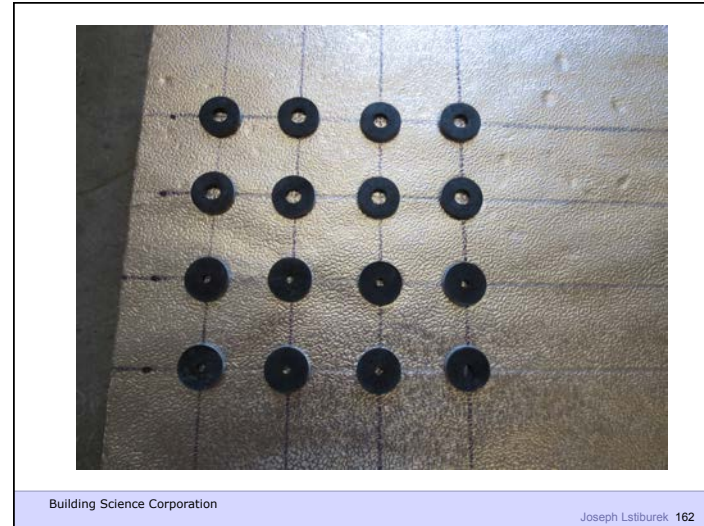

Beer Screen?

Building Science Corporation
Joseph Lstiburek 163

