

Joseph Lstiburek, Ph.D., P.Eng., ASHRAE Fellow

# Stuck on You

Building Science Corporation

## The Perfect Wall

2

- Water Control Layer
- Air Control Layer
- Vapor Control Layer
- Thermal Control Layer

3

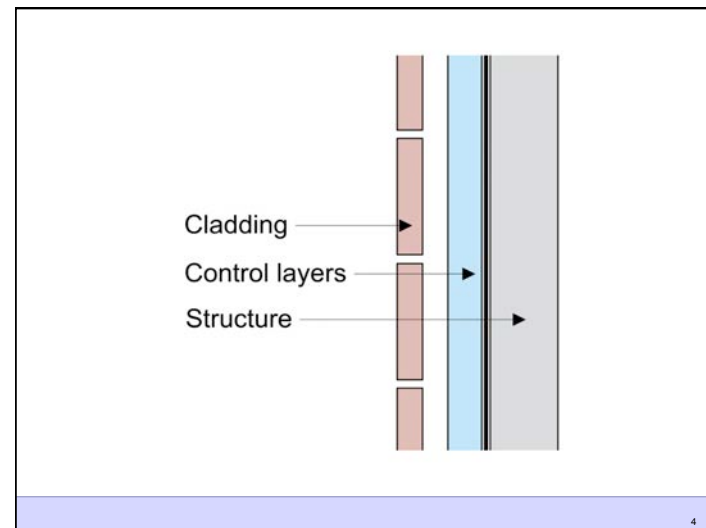

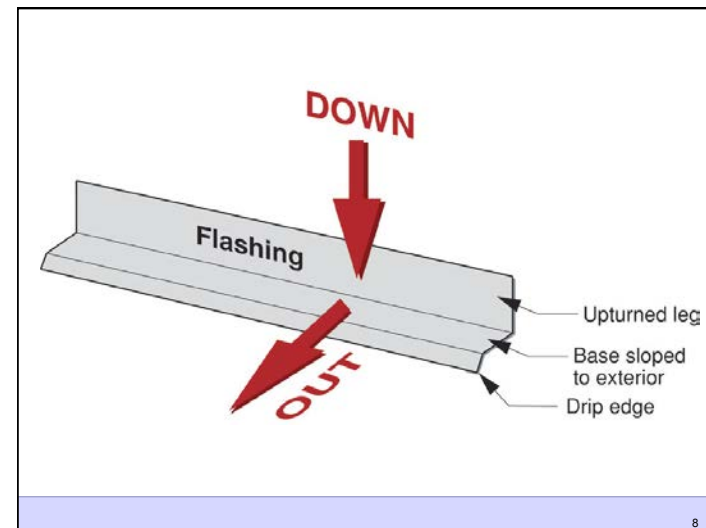
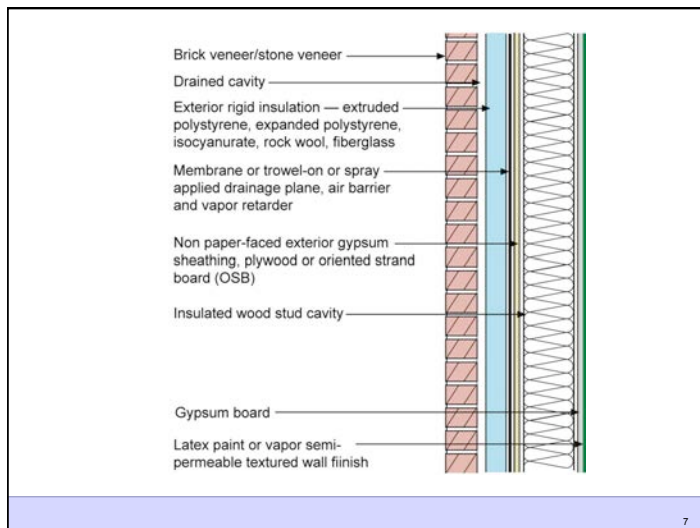
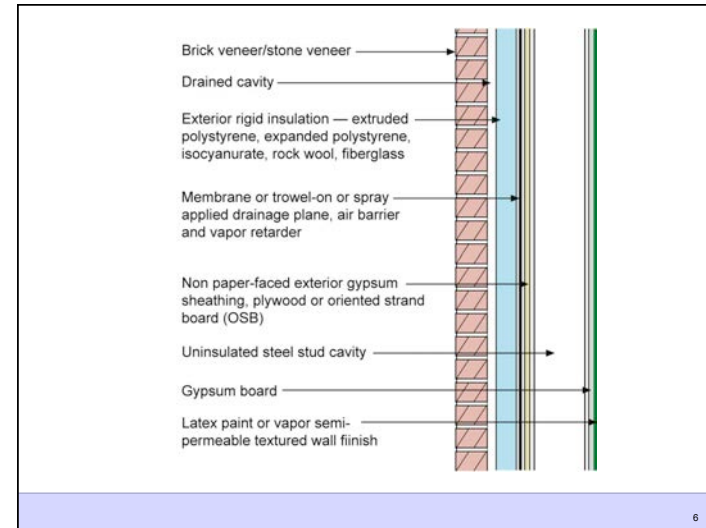
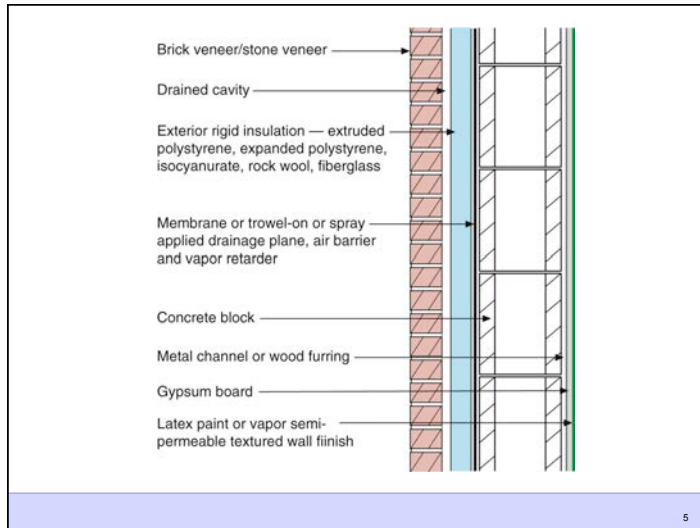

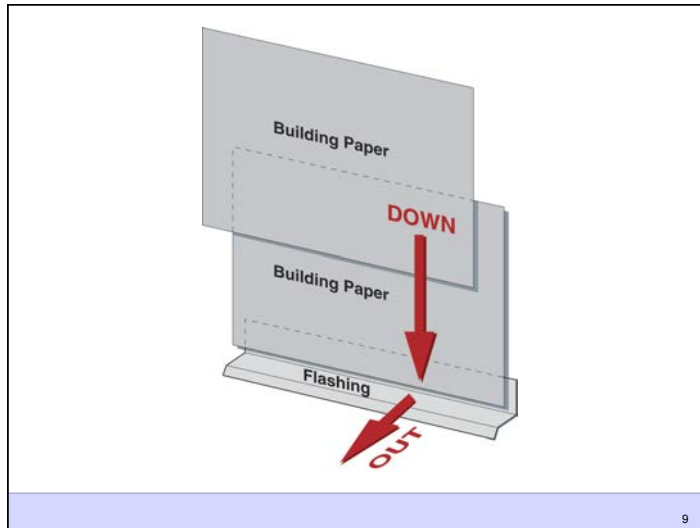

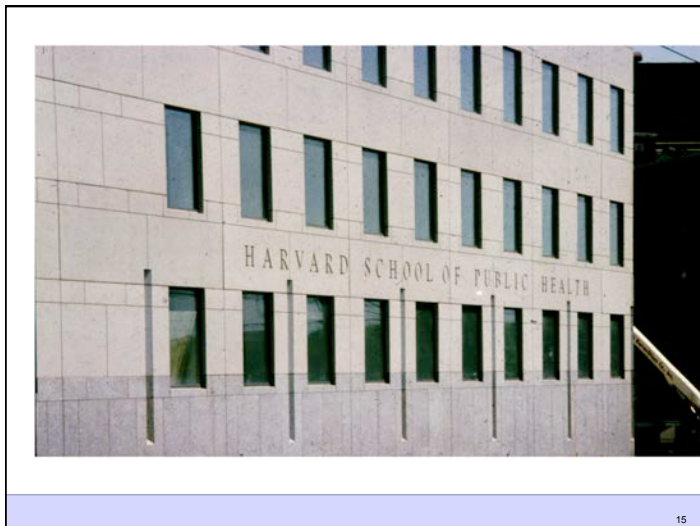
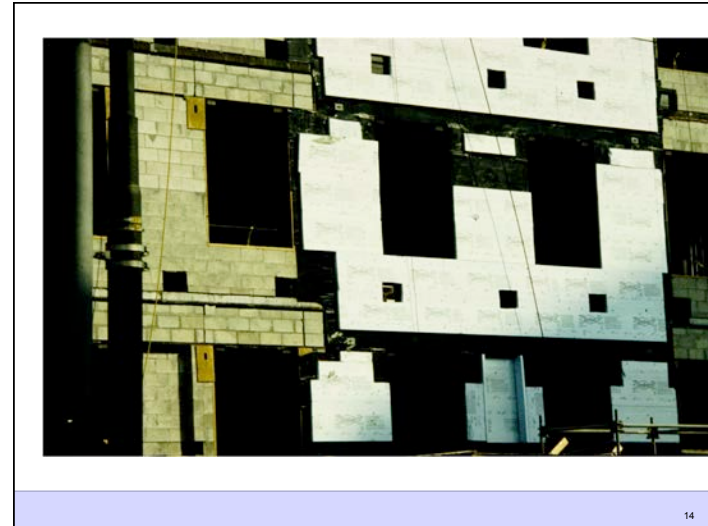

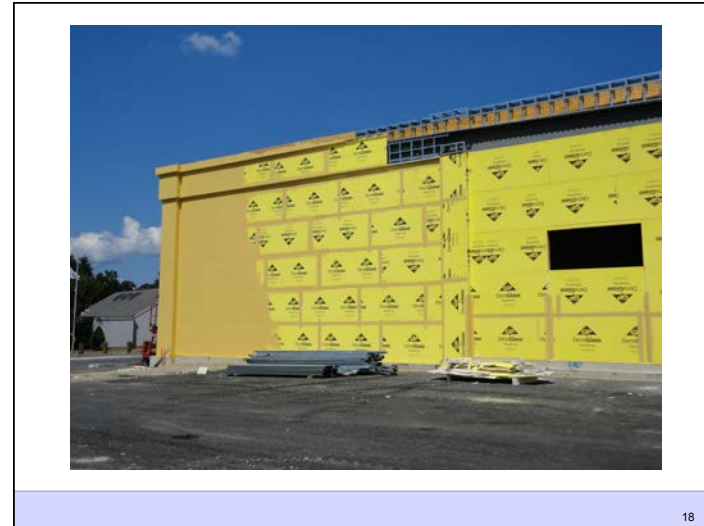
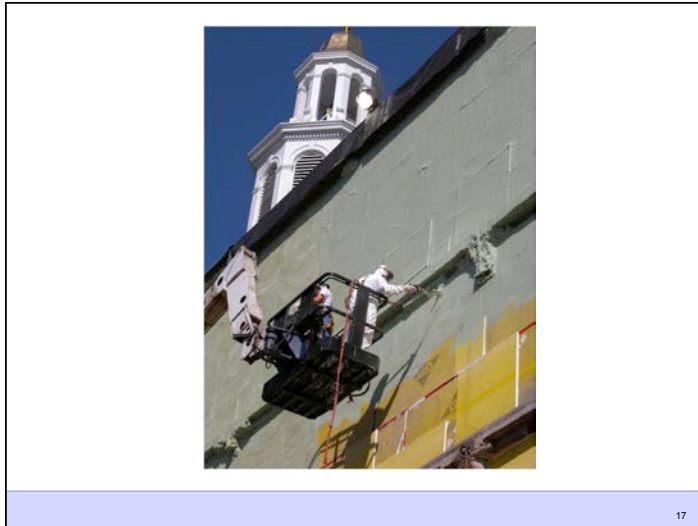

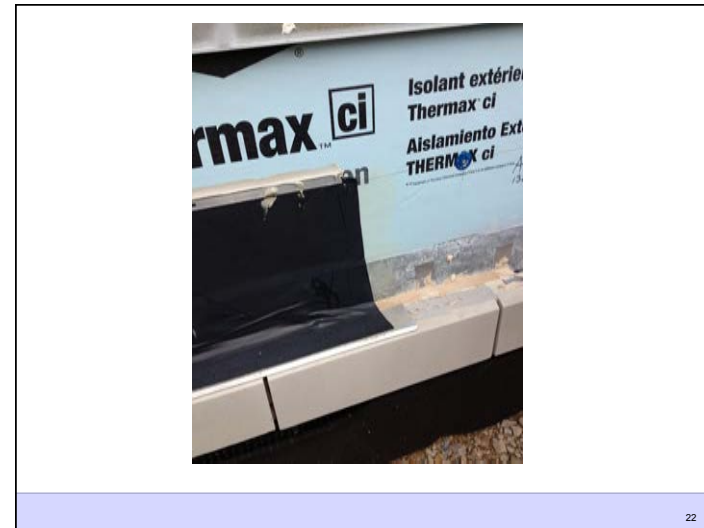

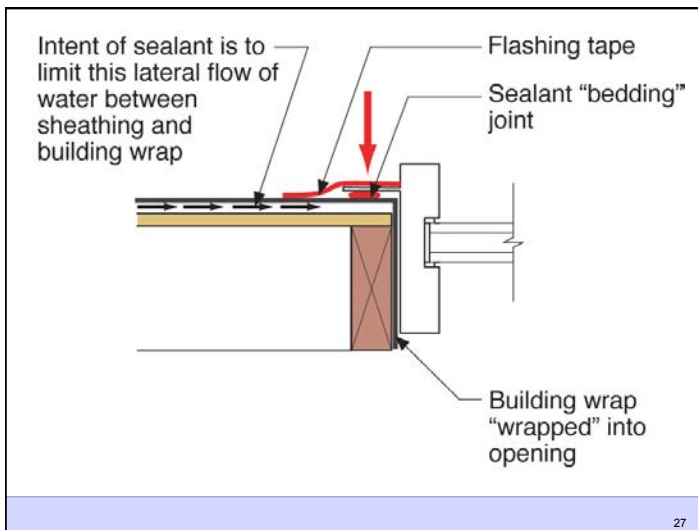
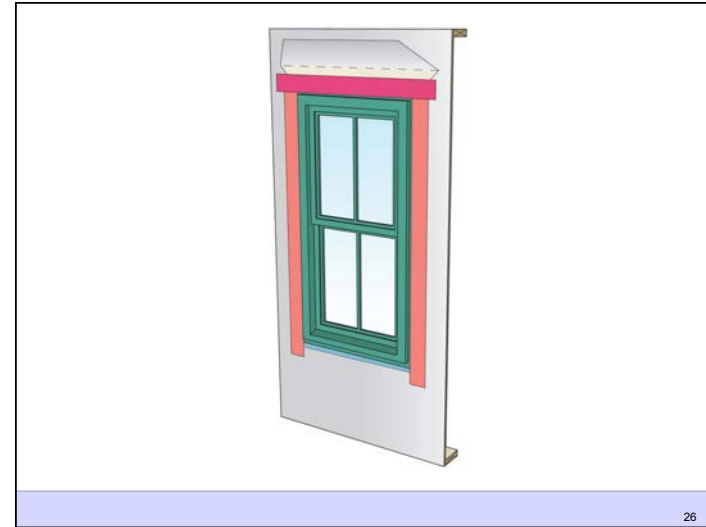









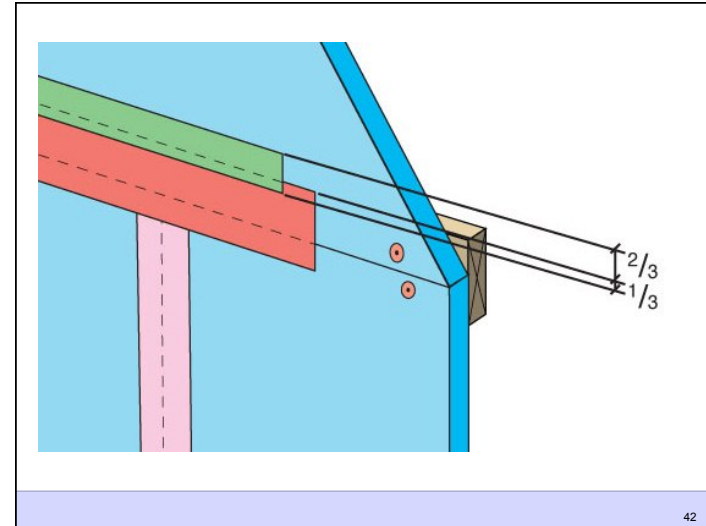

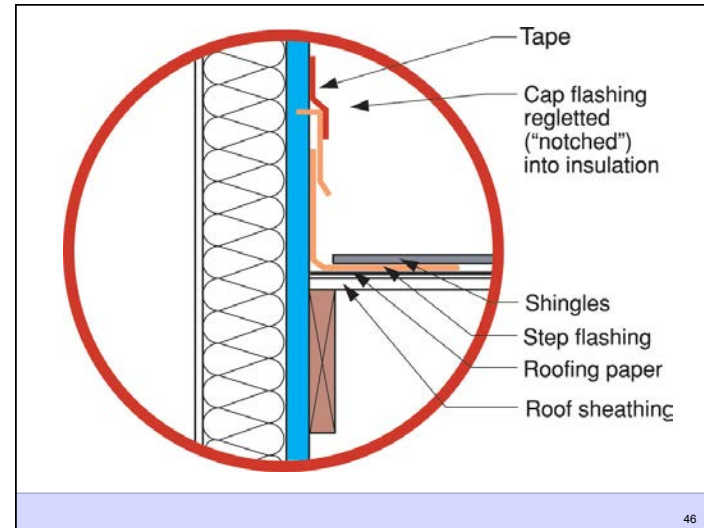



49

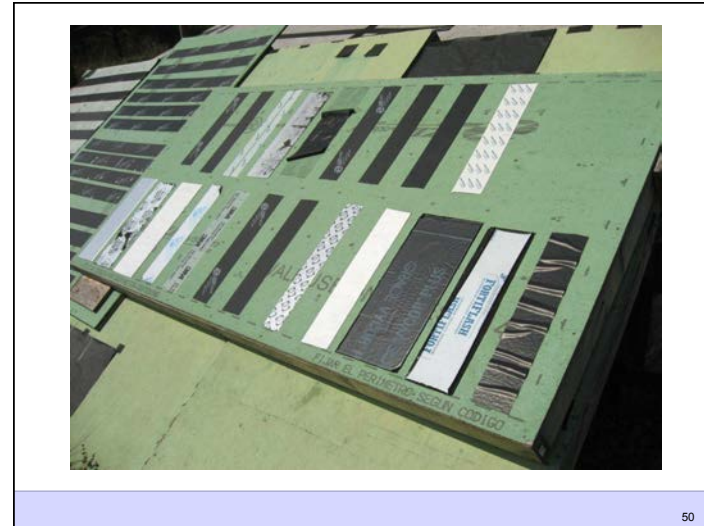

50

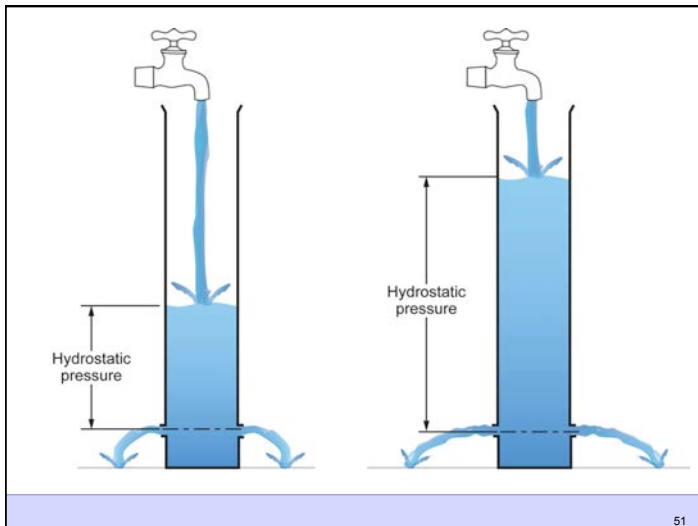

51



52

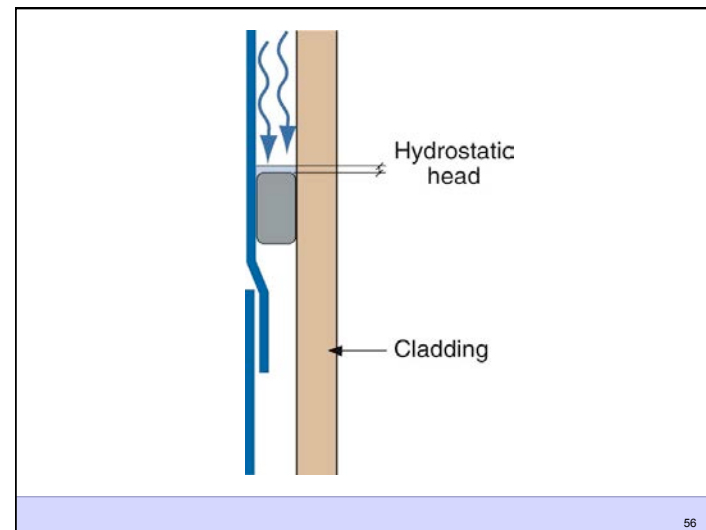
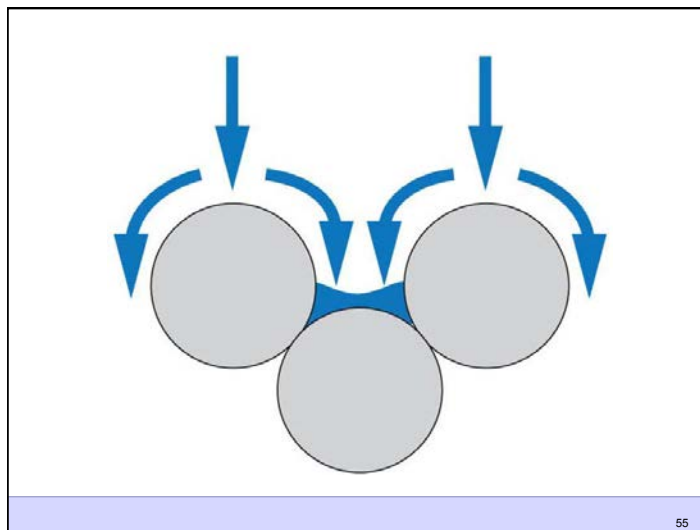
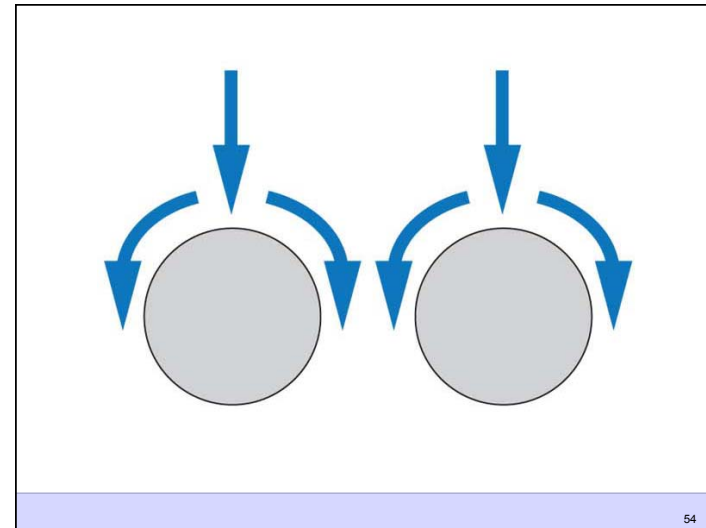
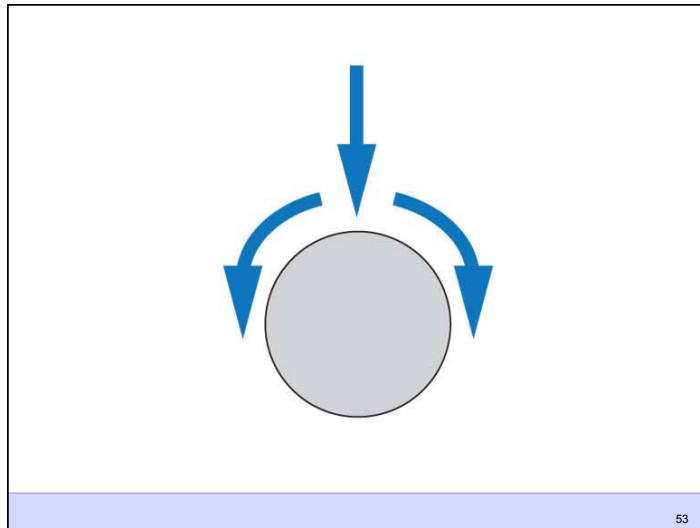

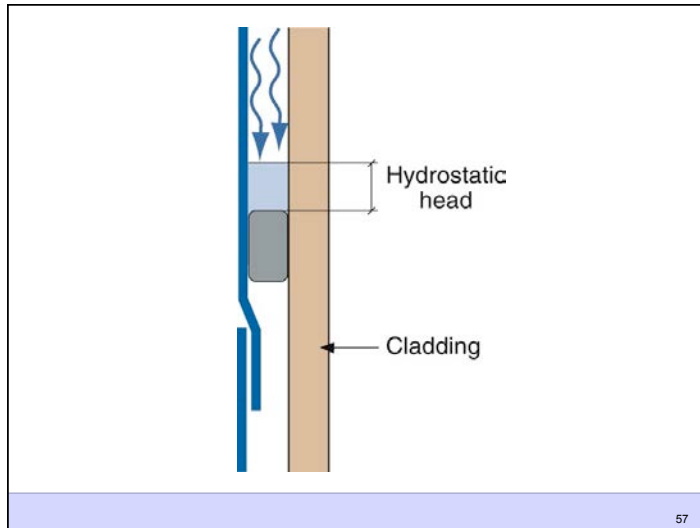

57

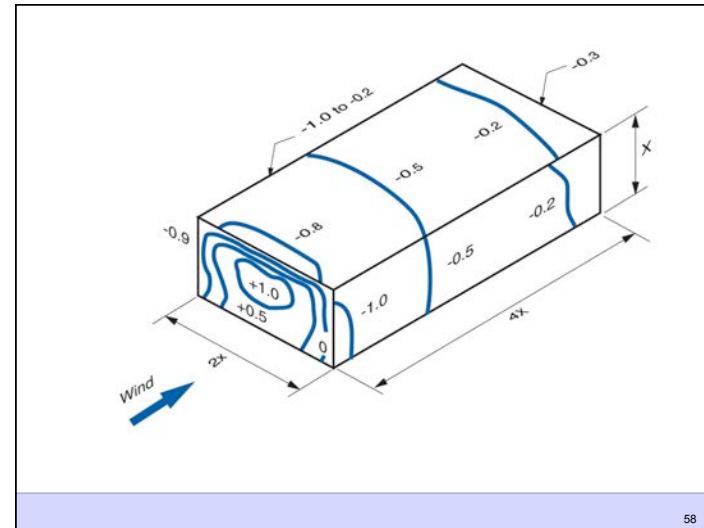

58

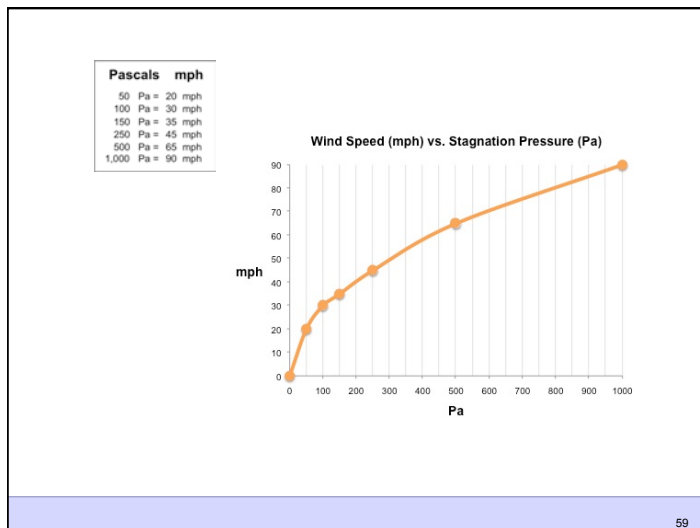

59



60

