

Joseph Lstiburek, Ph.D., P.Eng, ASHRAE Fellow

Building Science

Multifamily Podium Construction

www.buildingscience.com



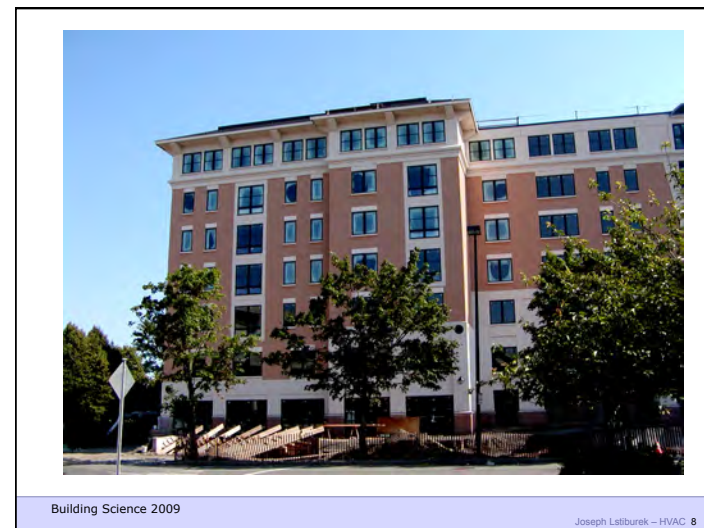



Building Science Corporation

Joseph Lstiburek 9

Heat flow is from warm to cold
Moisture flow is from more to less
Air flow is from a higher pressure to a lower pressure
Gravity acts down

Building Science Corporation

Joseph Lstiburek 10

A Building is an Environmental Separator

Building Science Corporation

Joseph Lstiburek 11

- Control heat flow
- Control airflow
- Control water vapor flow
- Control rain
- Control ground water
- Control light and solar radiation
- Control noise and vibrations
- Control contaminants, environmental hazards and odors
- Control insects, rodents and vermin
- Control fire
- Provide strength and rigidity
- Be durable
- Be aesthetically pleasing
- Be economical

Building Science Corporation

Joseph Lstiburek 12

Water Control Layer
Air Control Layer
Vapor Control Layer
Thermal Control Layer

Building Science Corporation Joseph Lstiburek 13

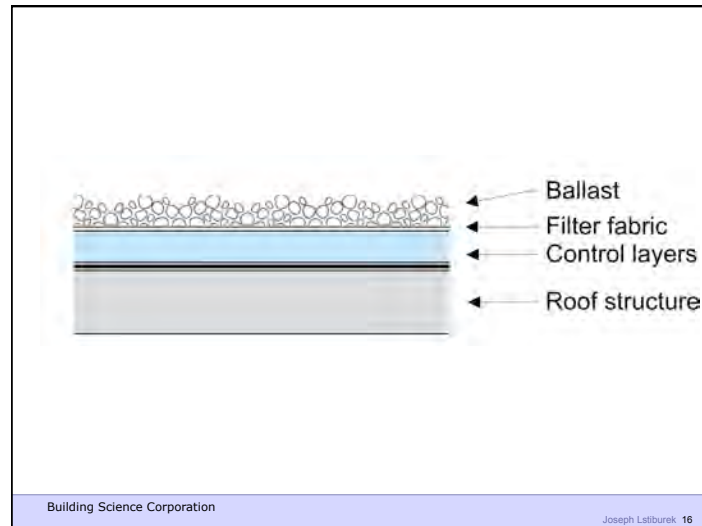
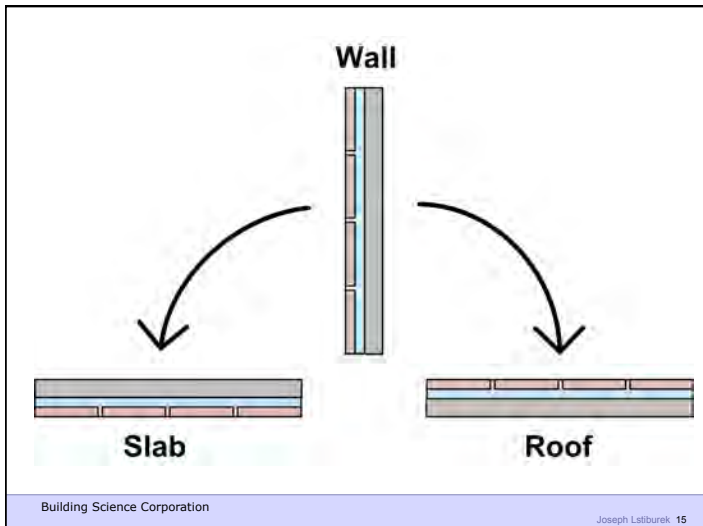
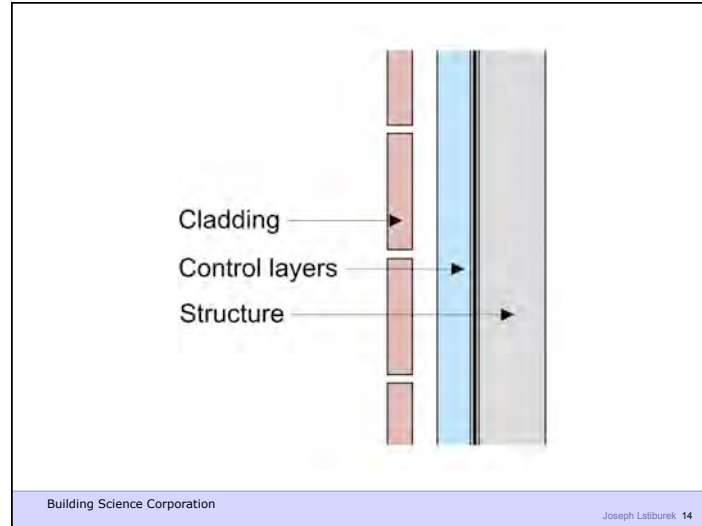

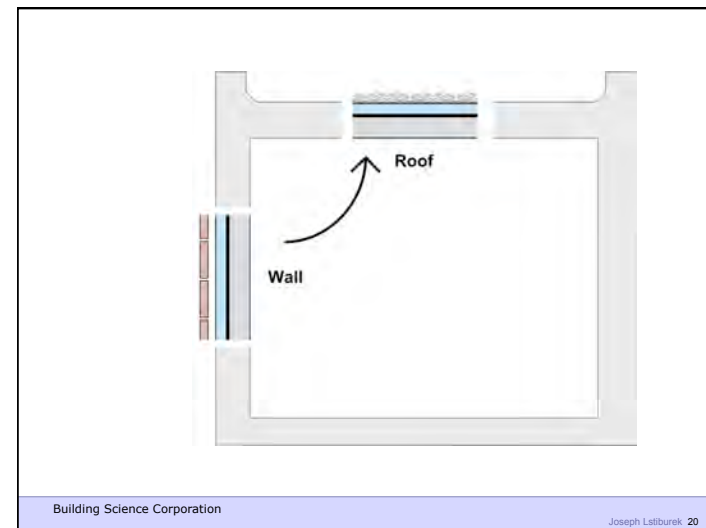
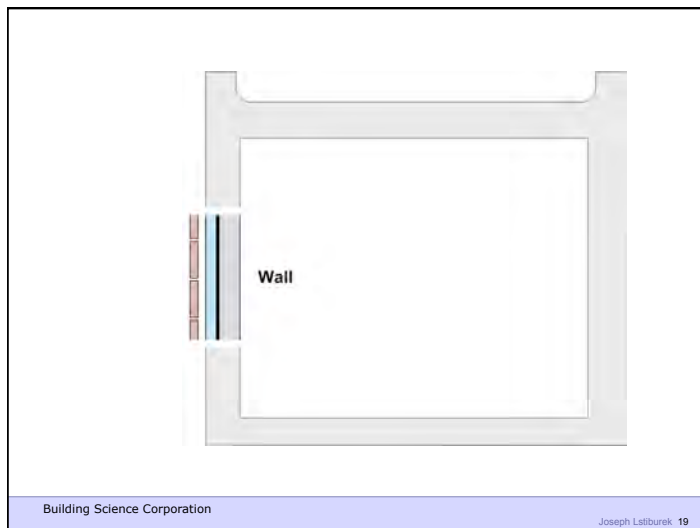
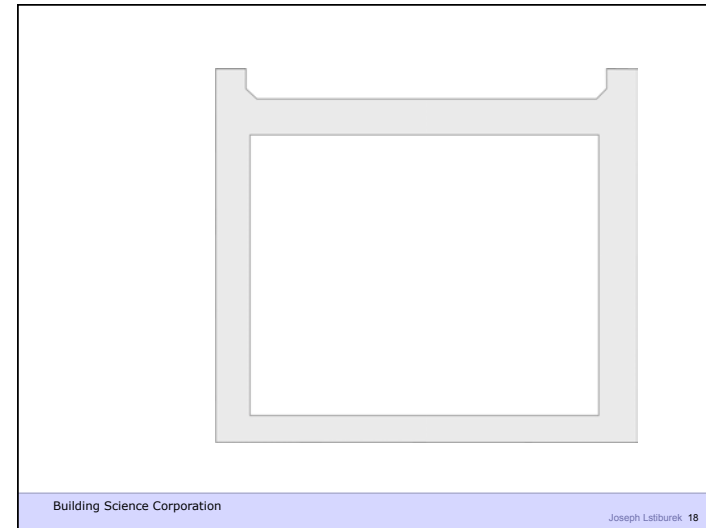
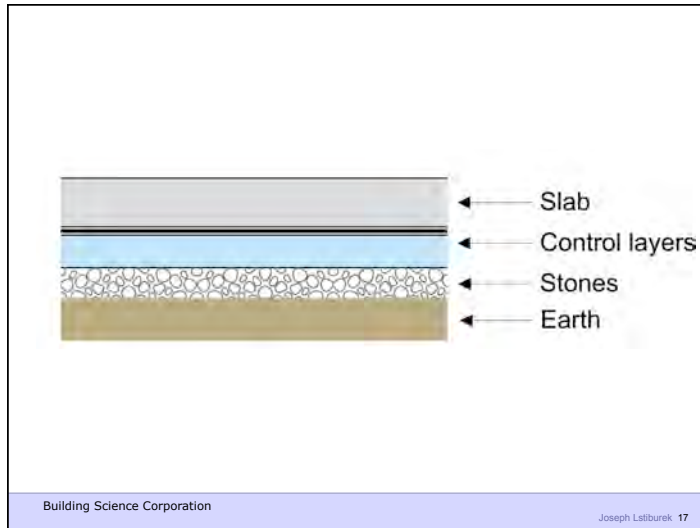

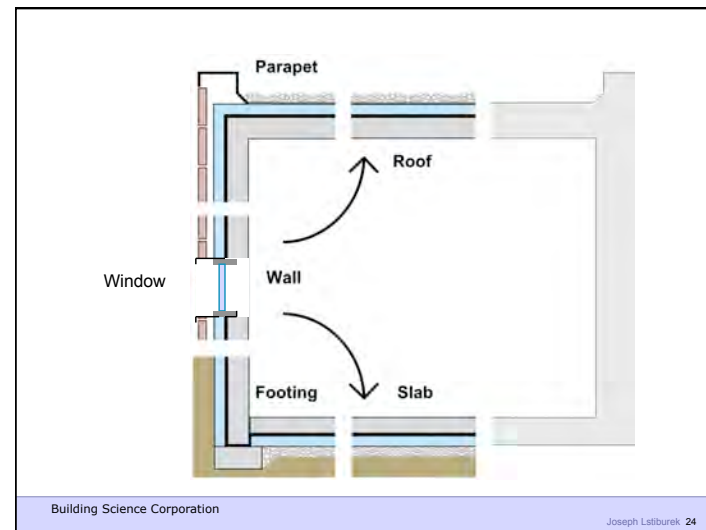
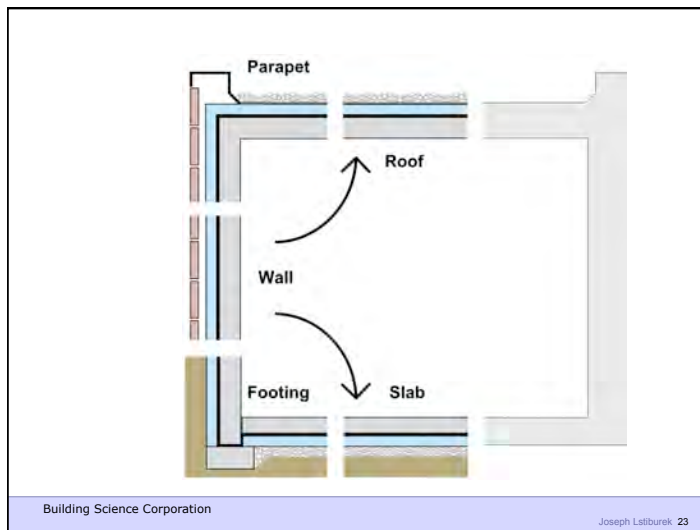
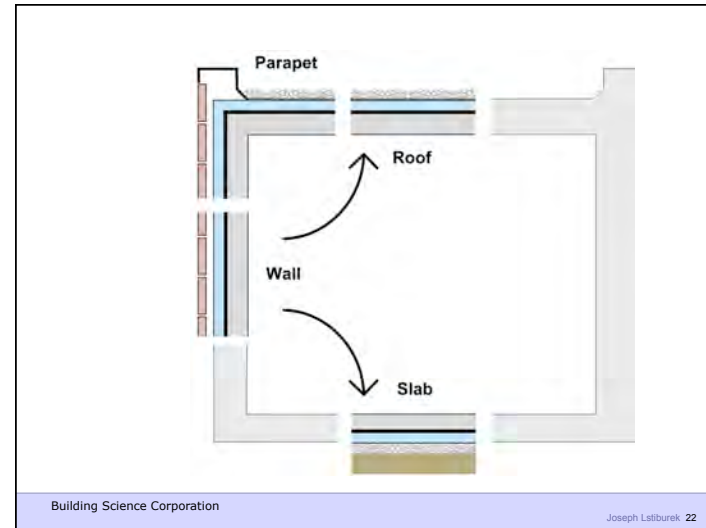
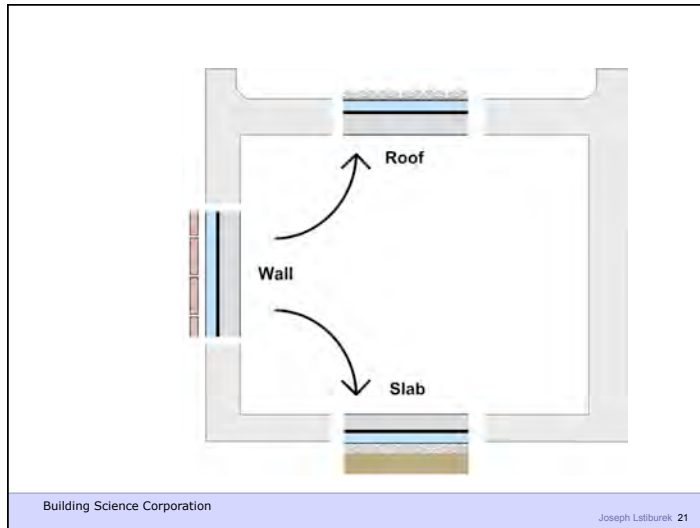

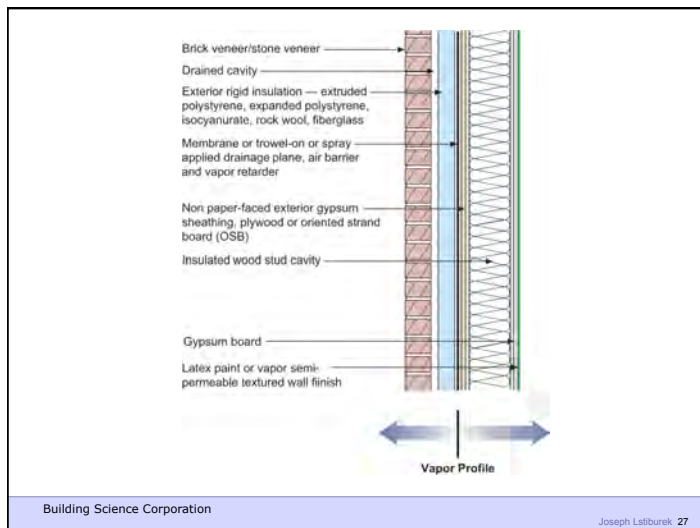
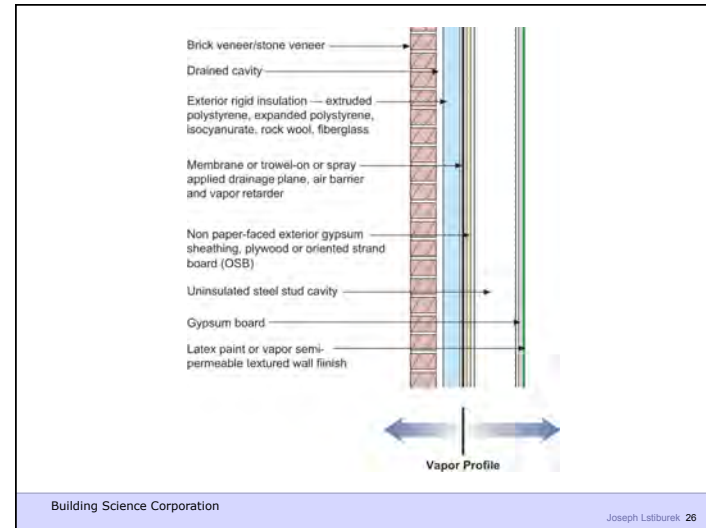
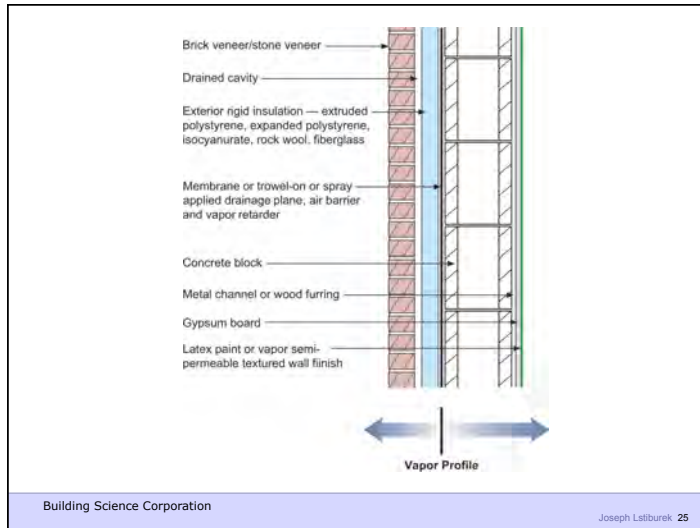

Commercial Enclosure: Simple Layers

- Structure
- Rain/Air/Vapor
- Insulation
- Finish

Building Science Corporation Joseph Lstiburek 28

Enclosure Design: Details

- Details demand the same approach as the enclosure.
- Scaled drawings required at 

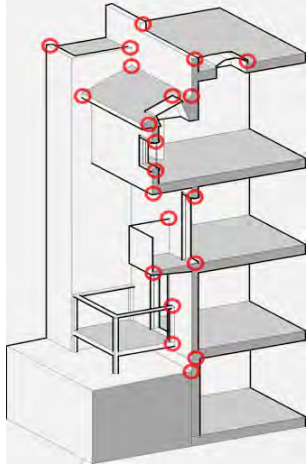

Building Science Corporation Joseph Lstiburek 29



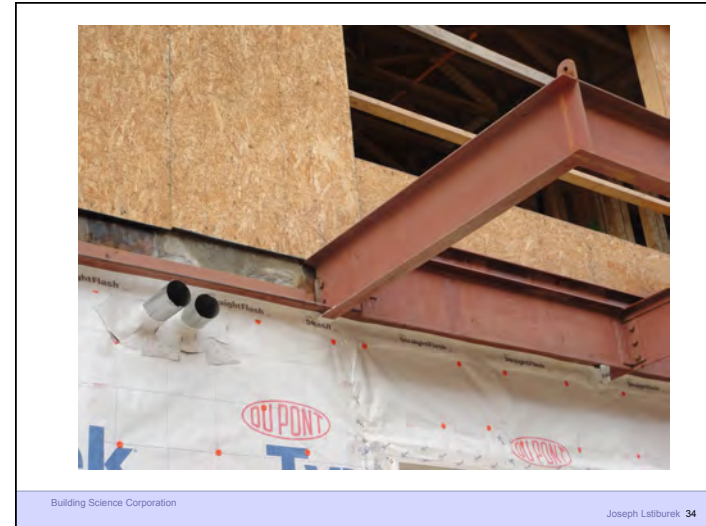

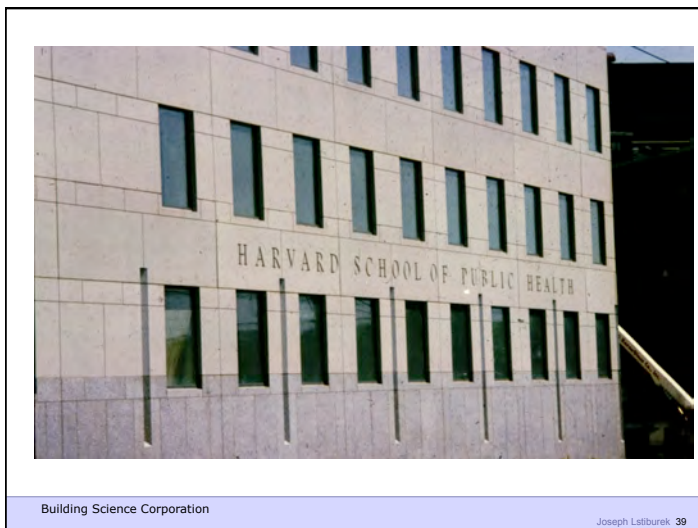

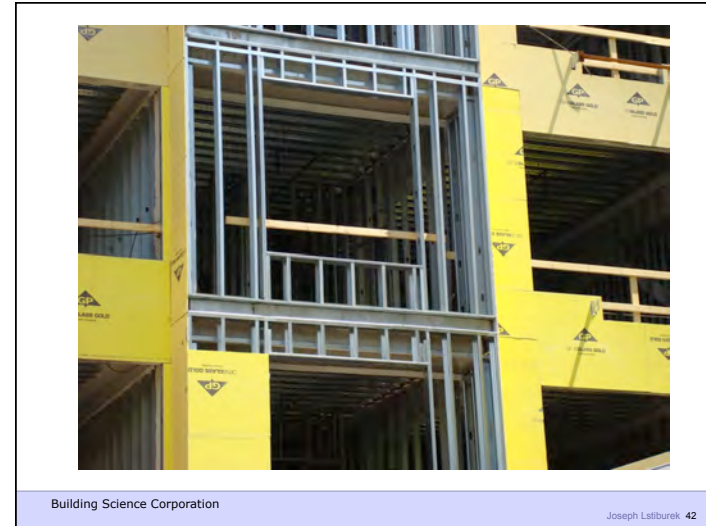

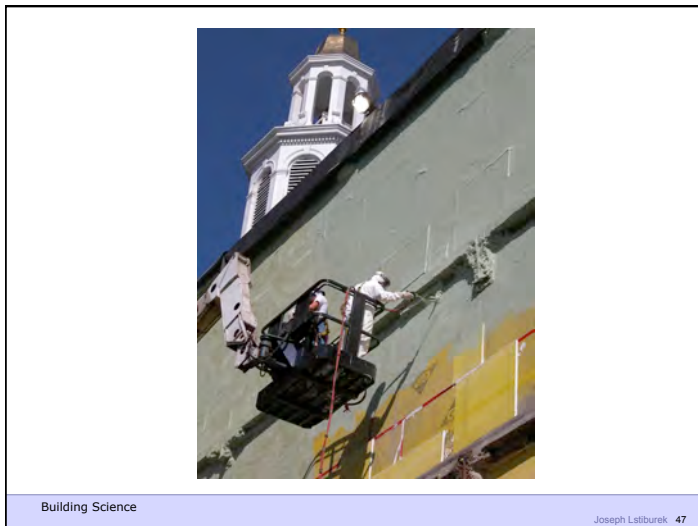
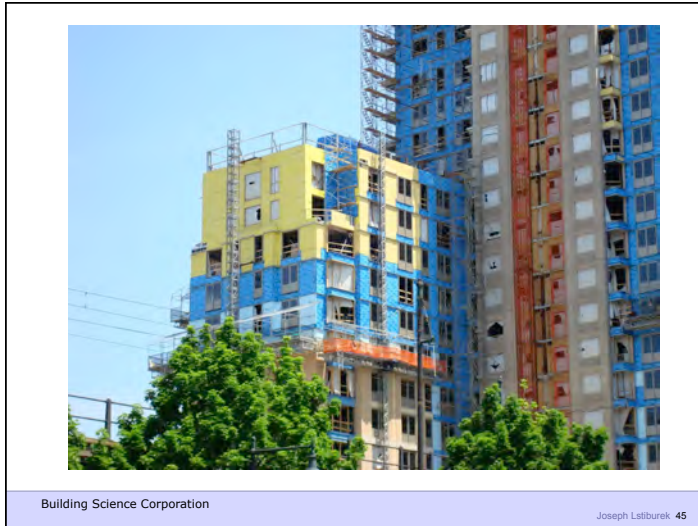





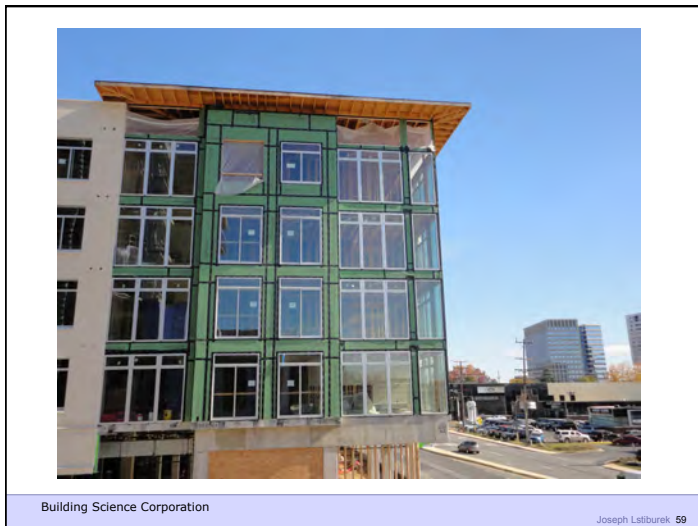
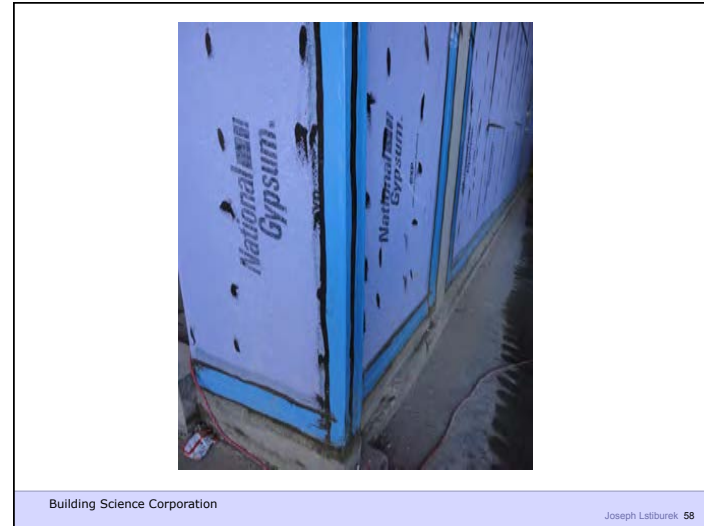

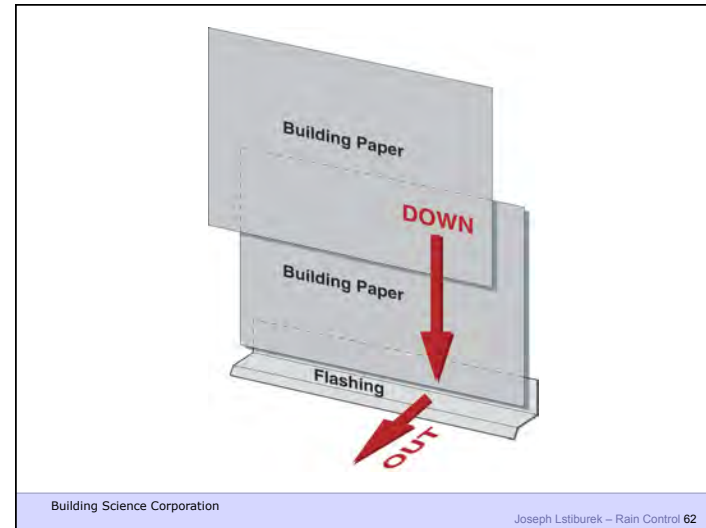
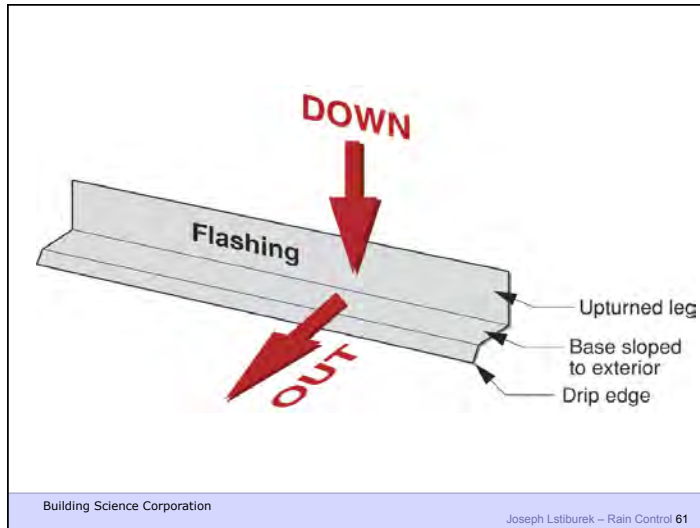

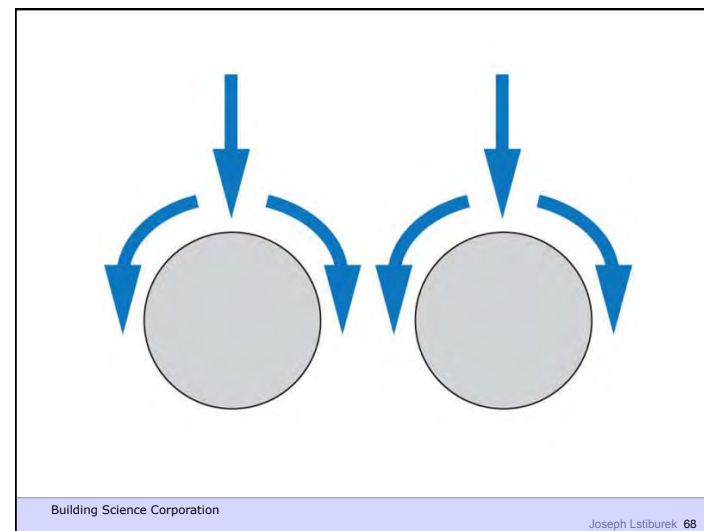
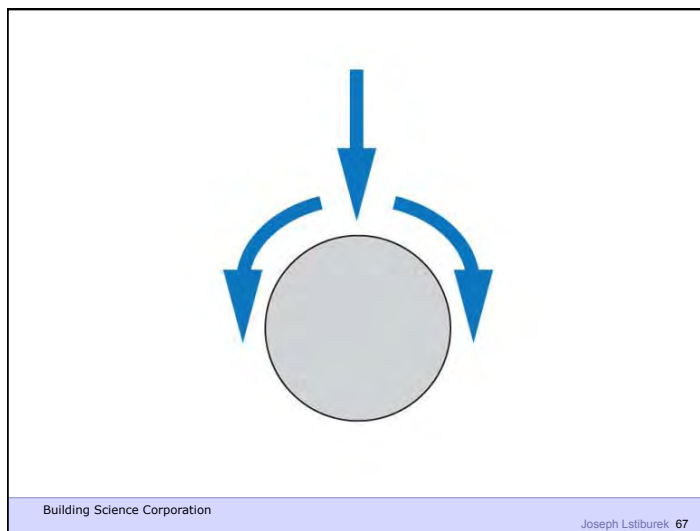
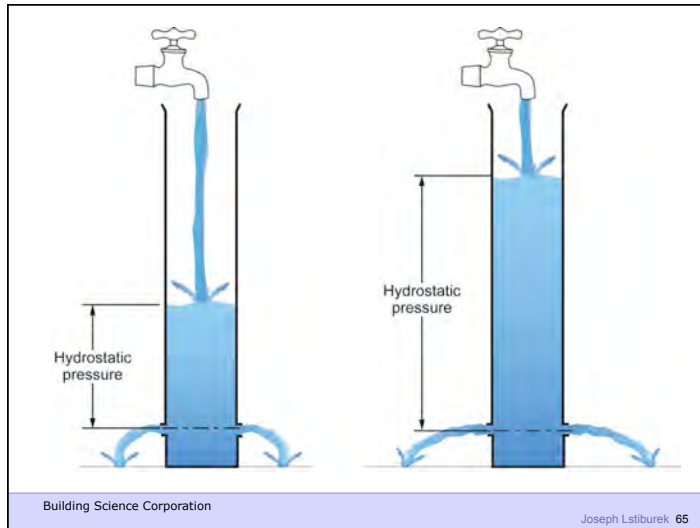

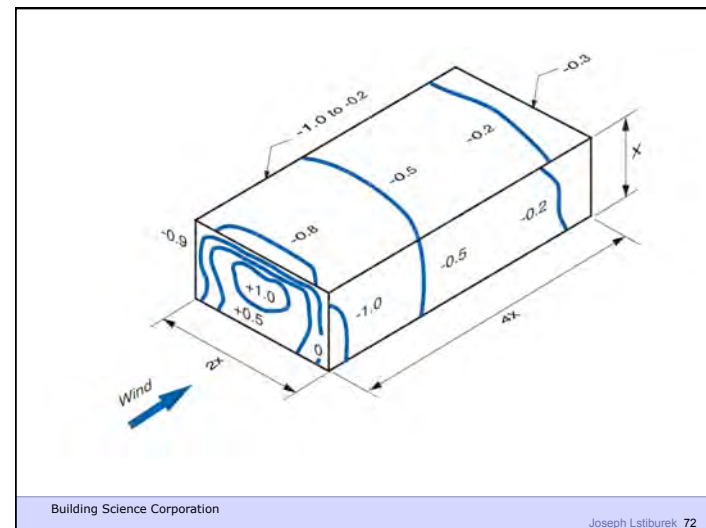
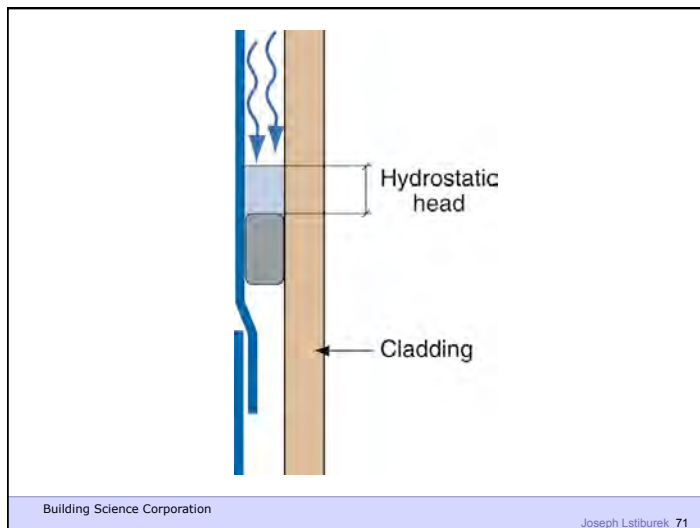
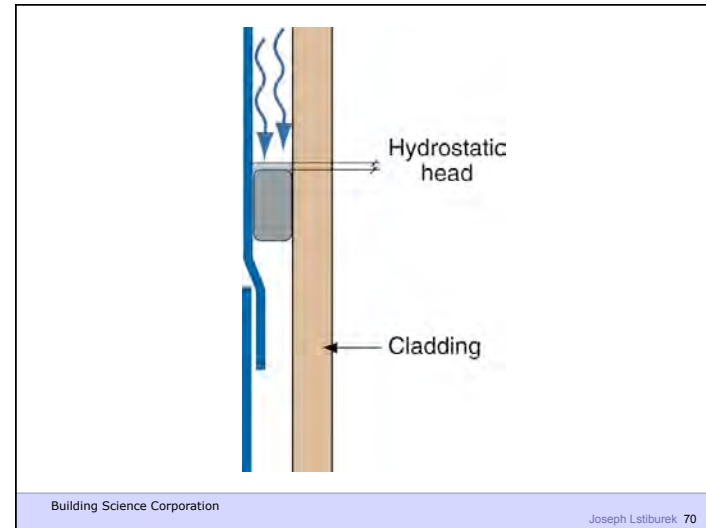
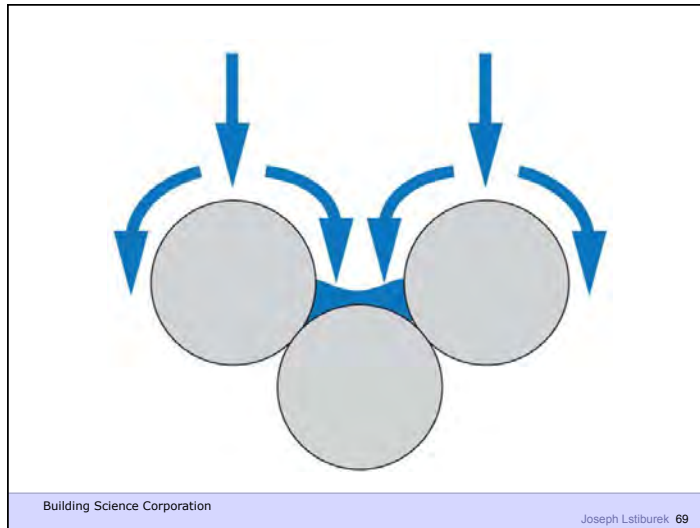

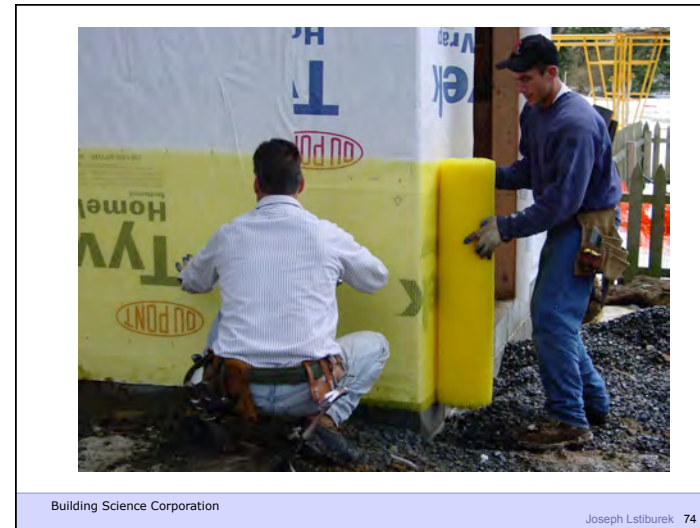
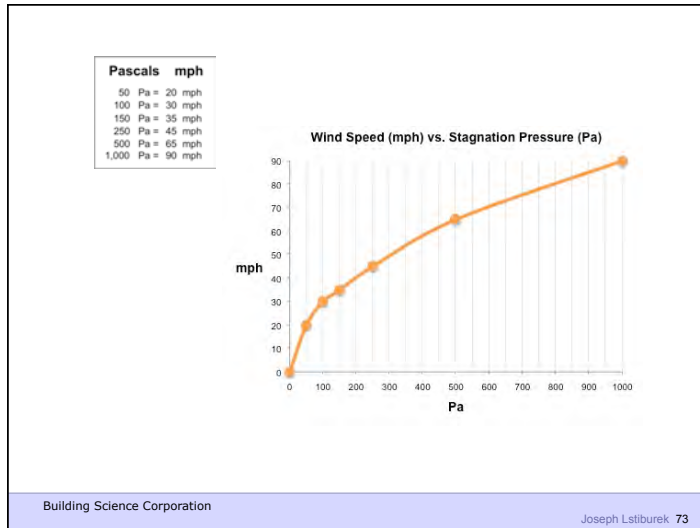

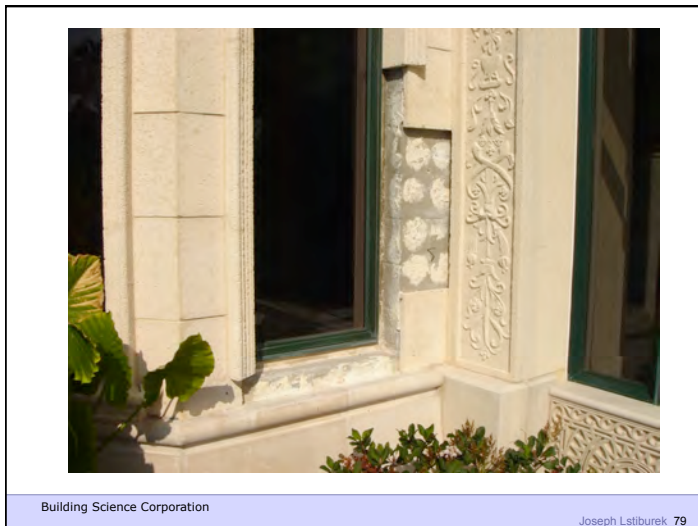
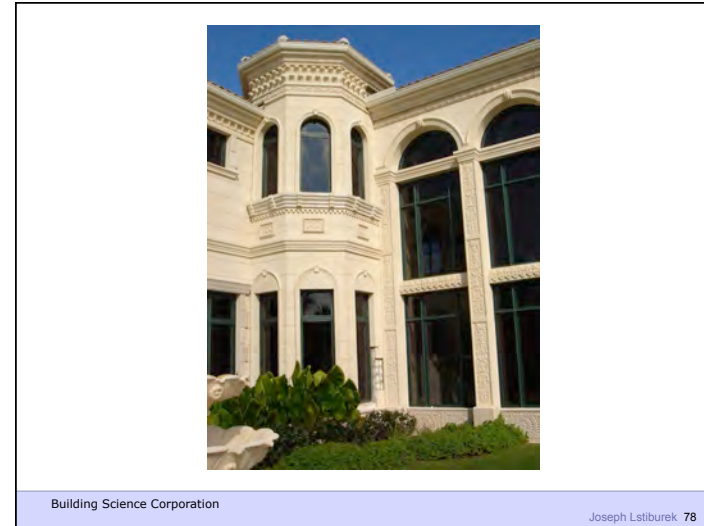

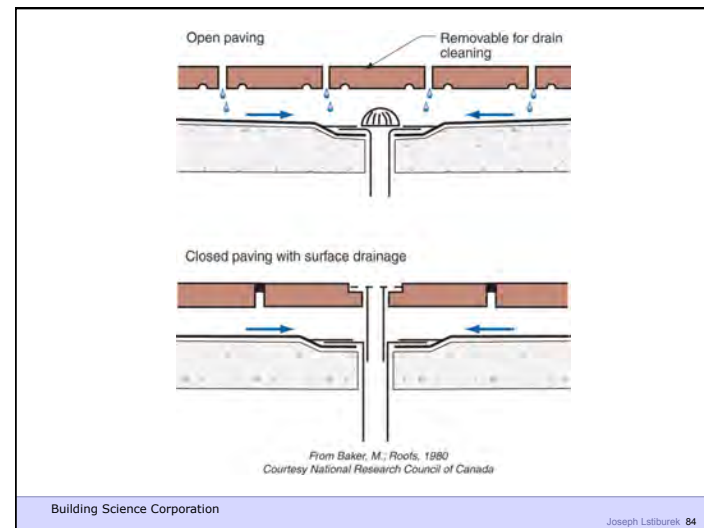
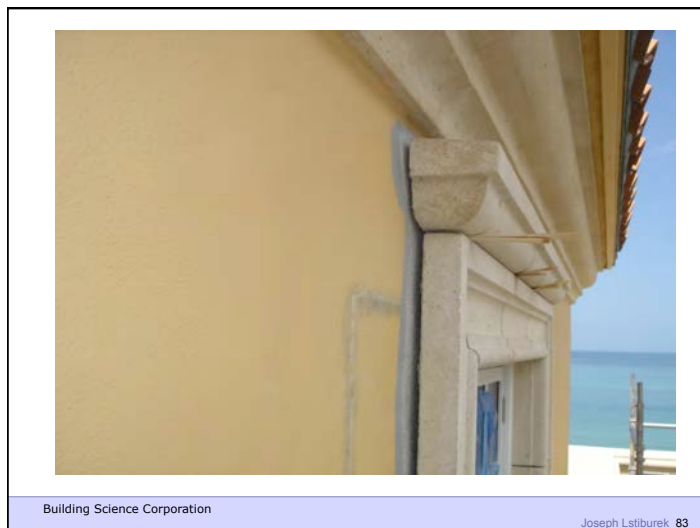
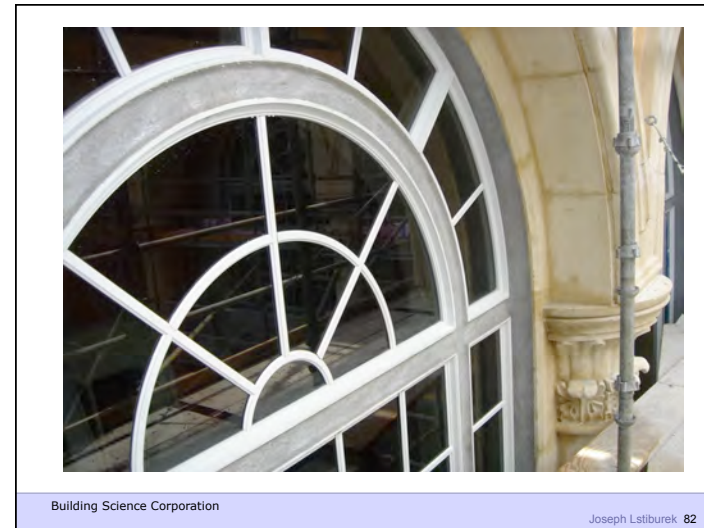
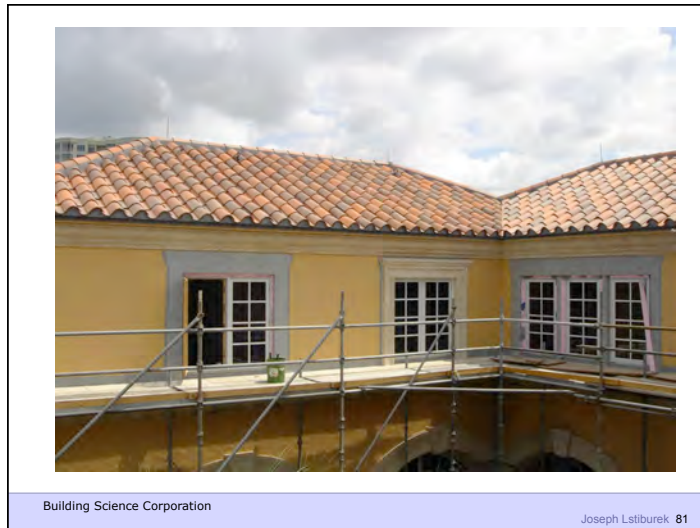

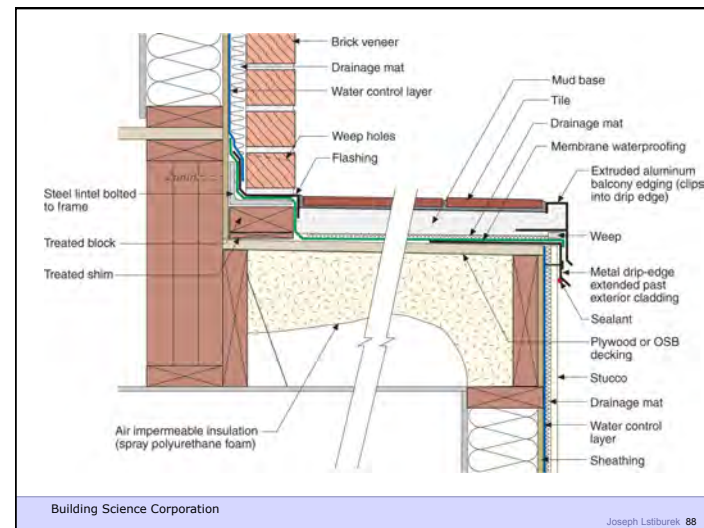
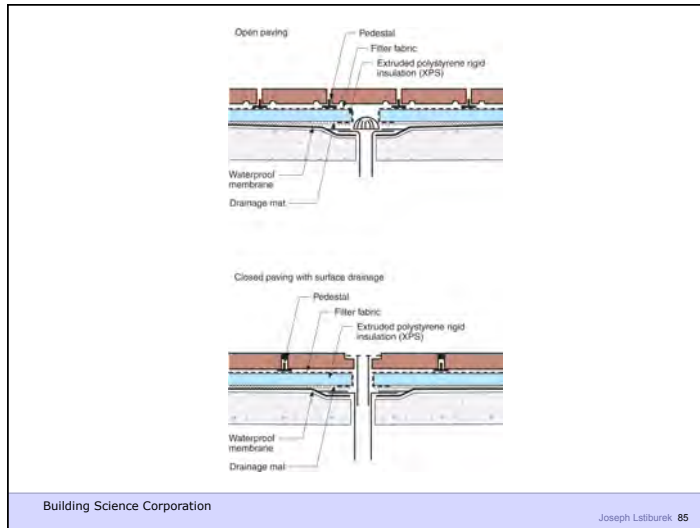

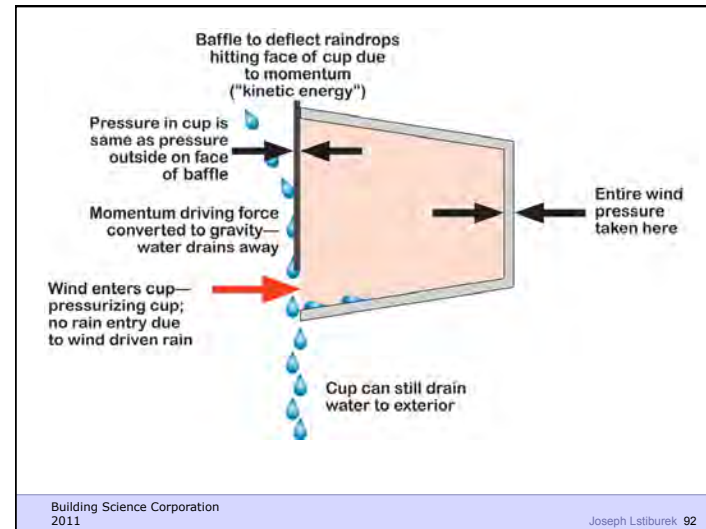
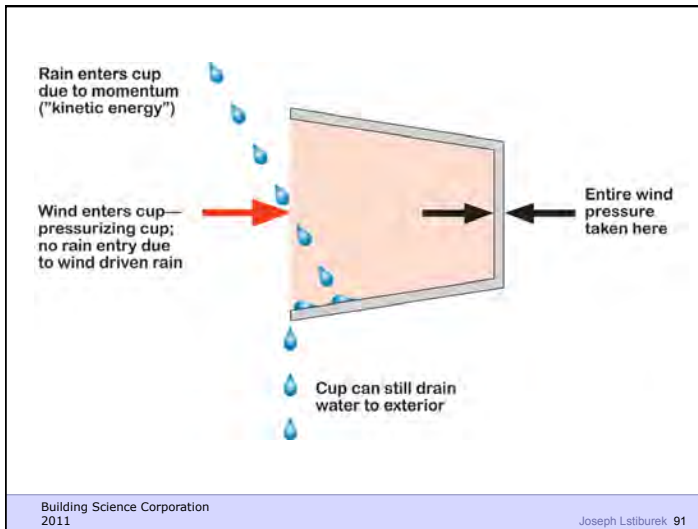
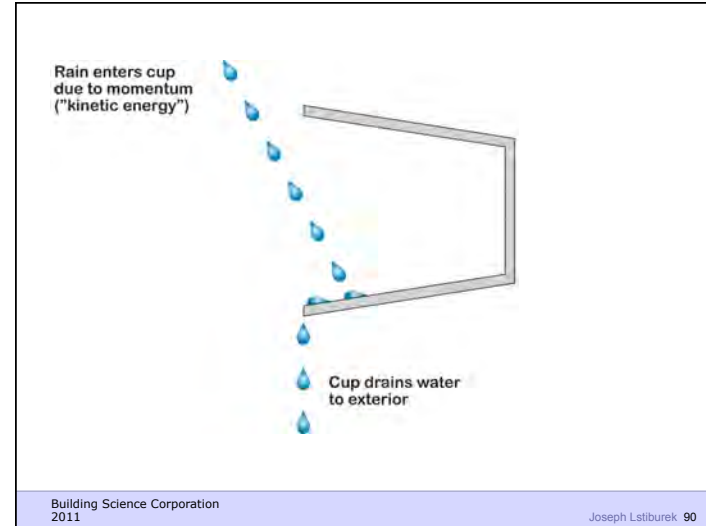

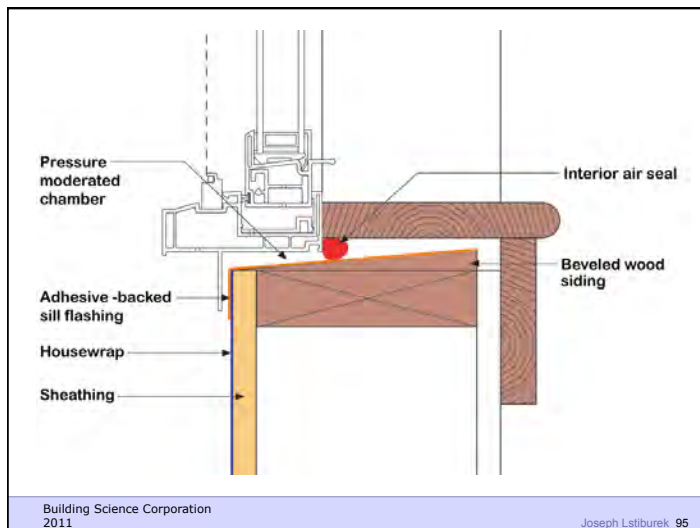
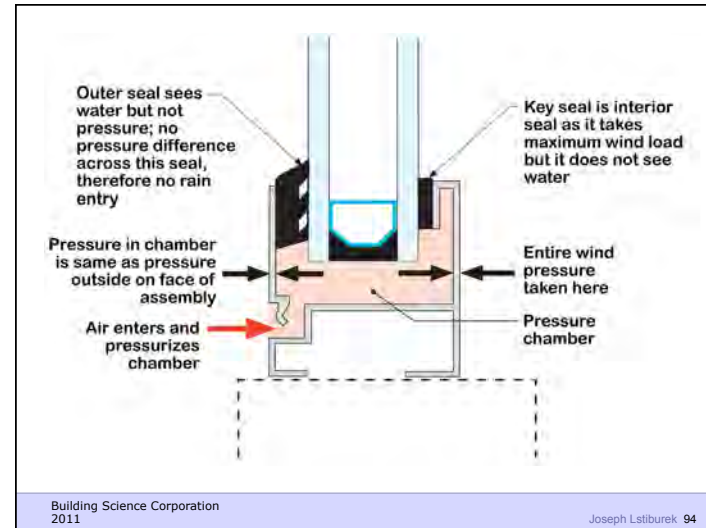
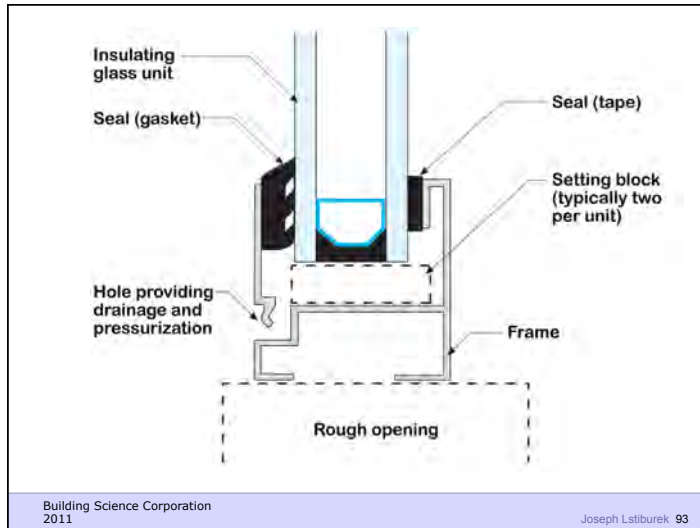

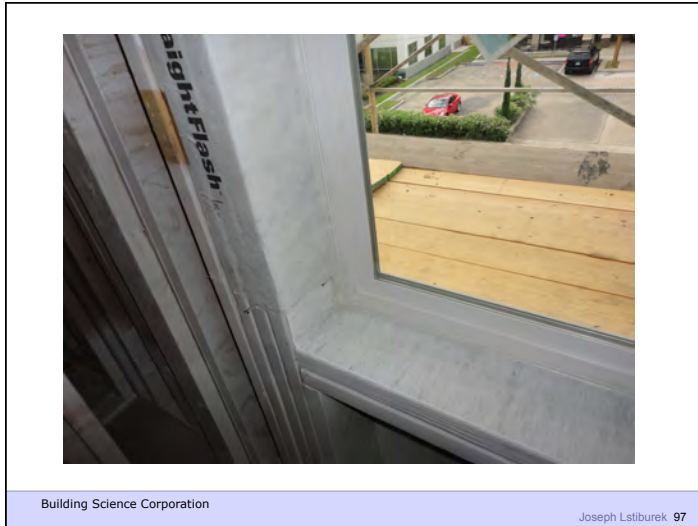

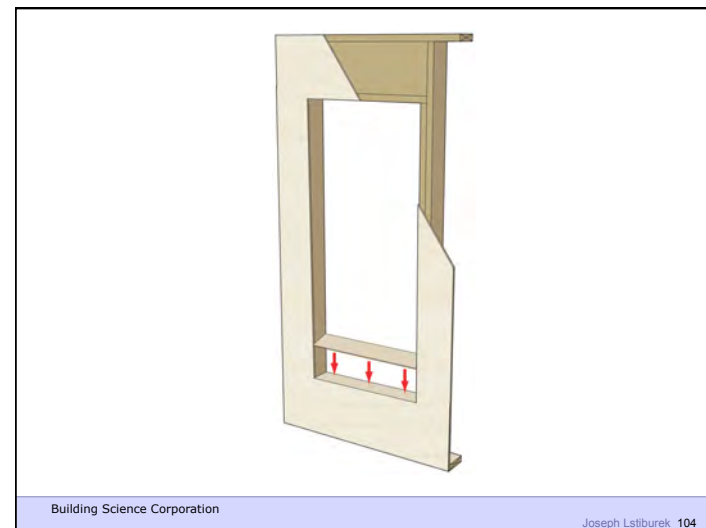
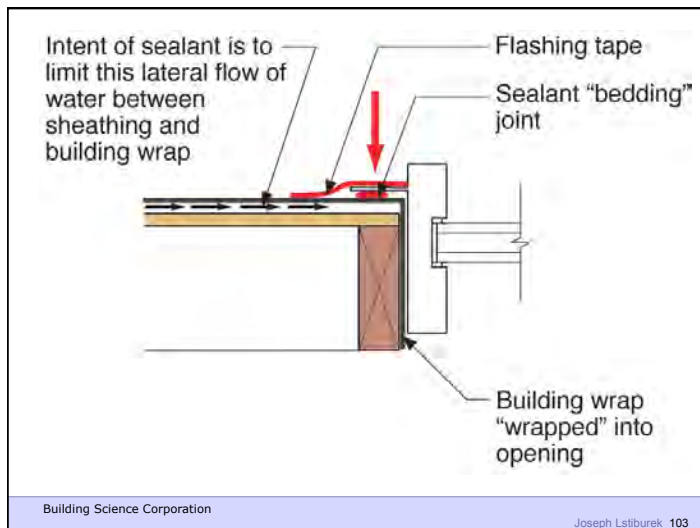
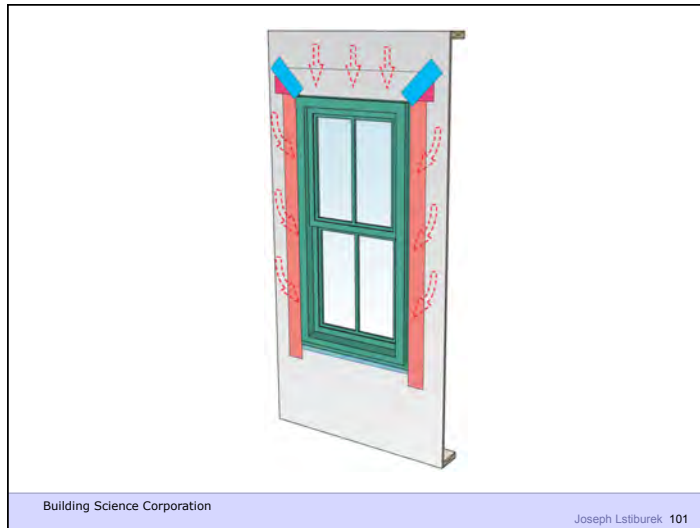

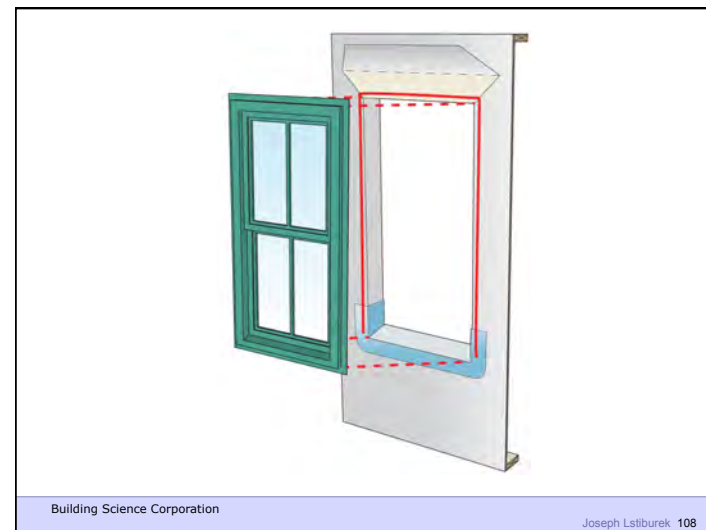
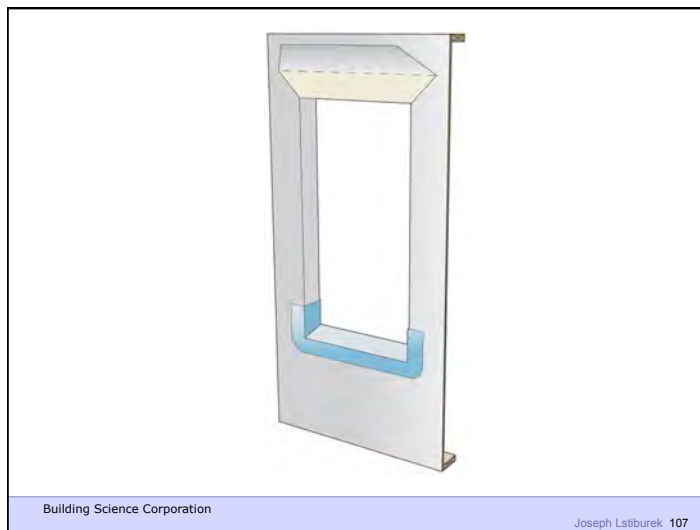
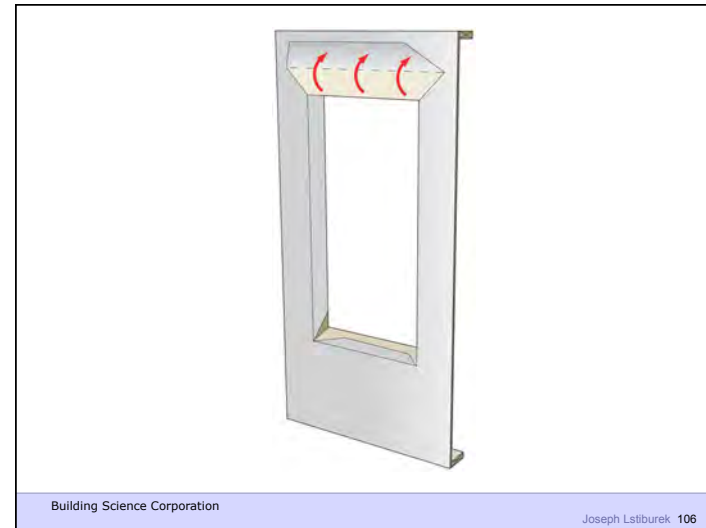
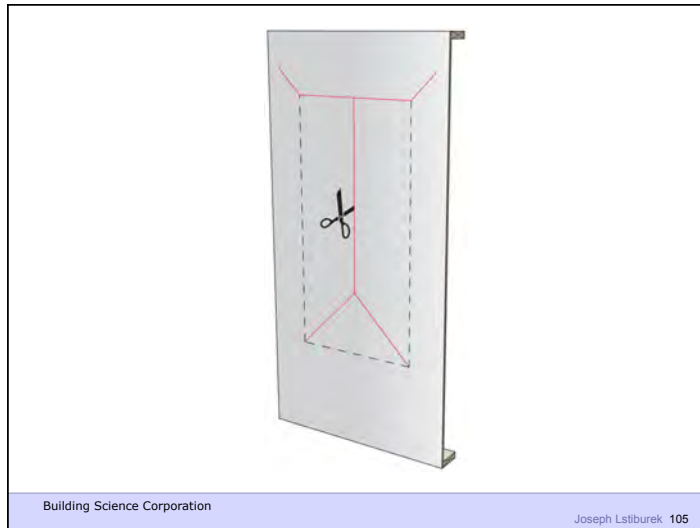

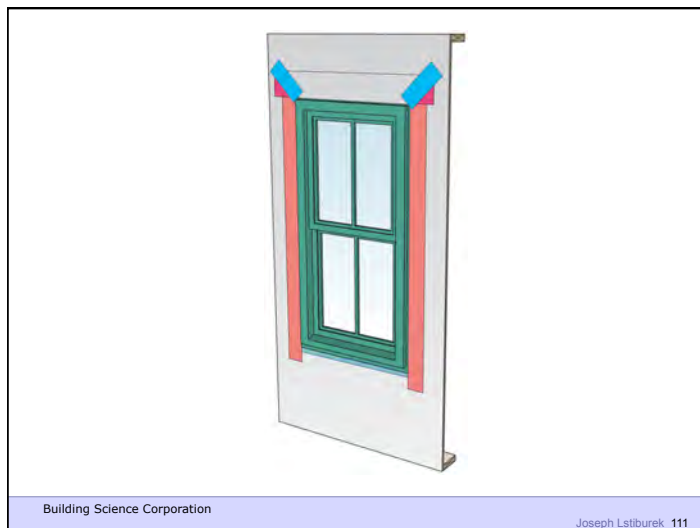

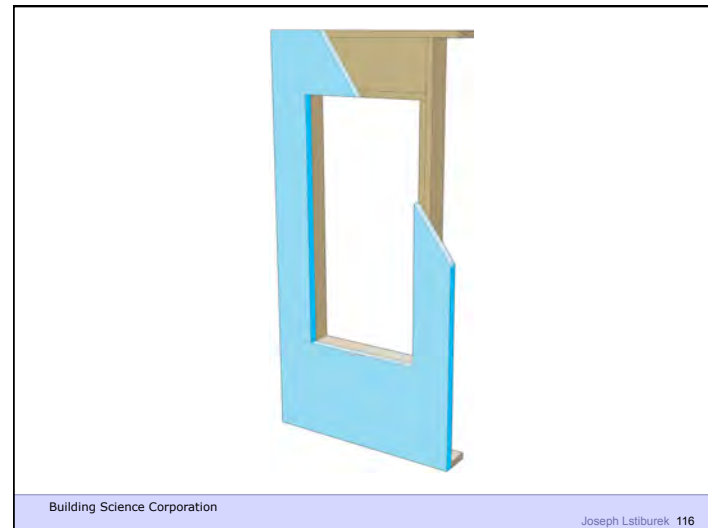
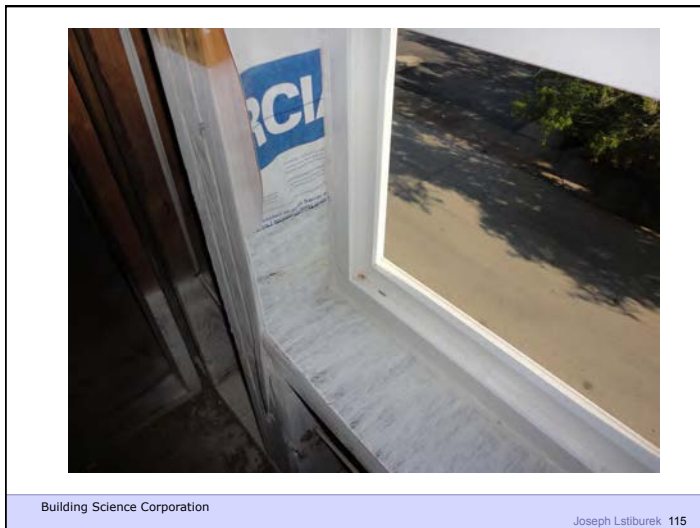

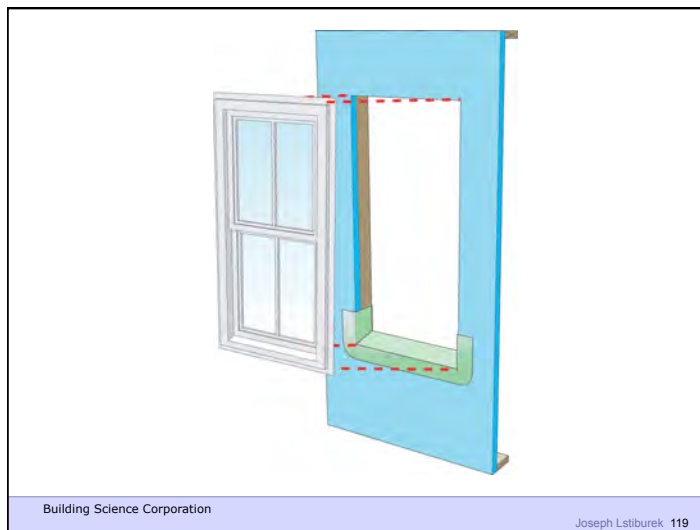
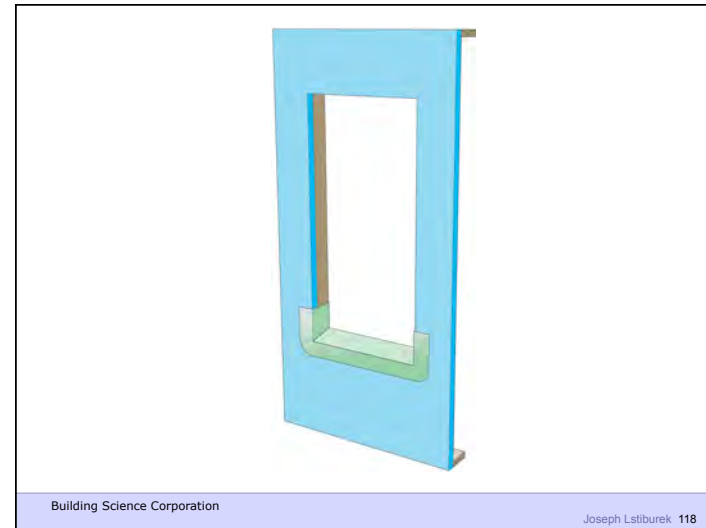
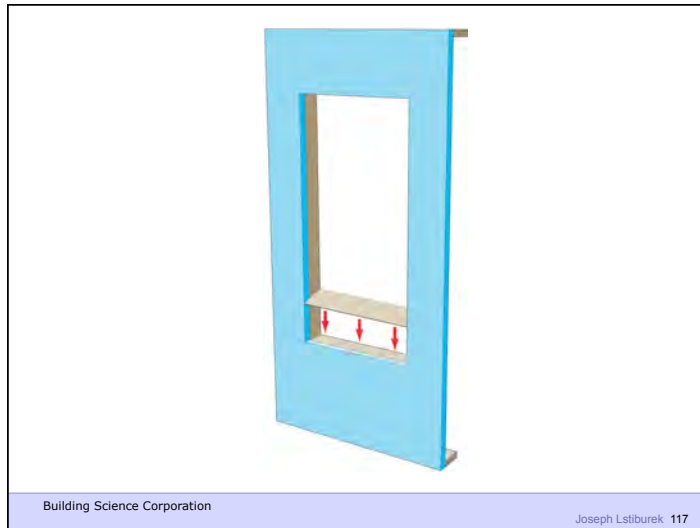



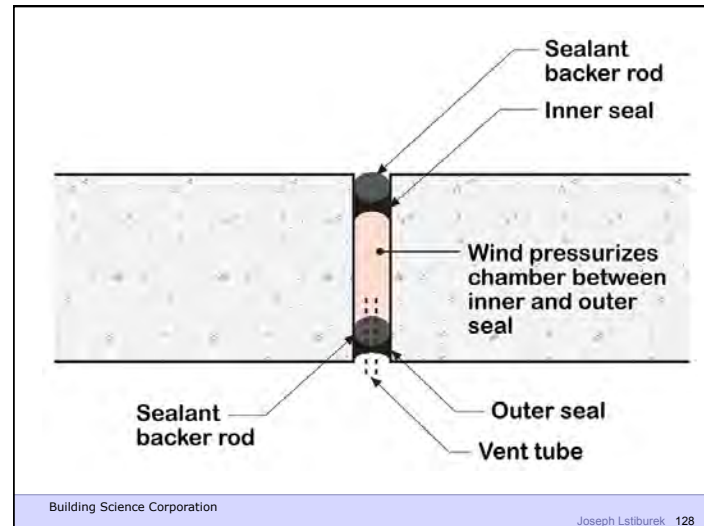

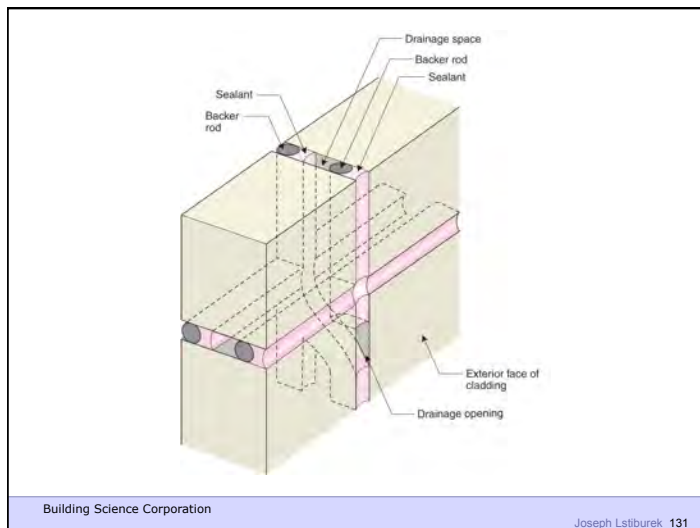
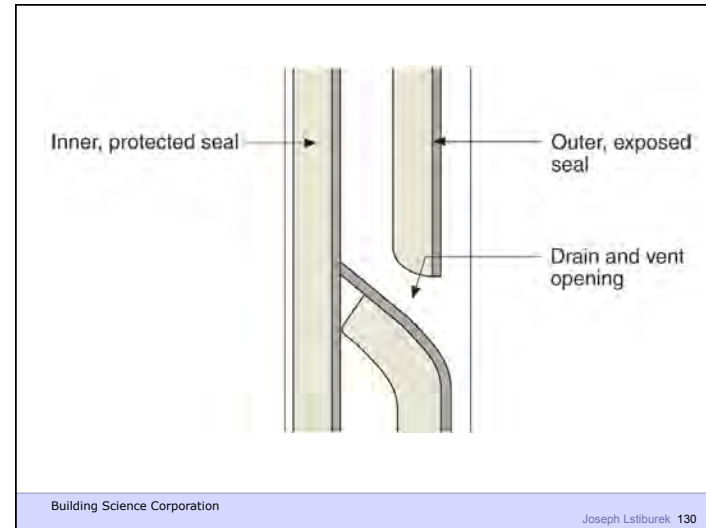
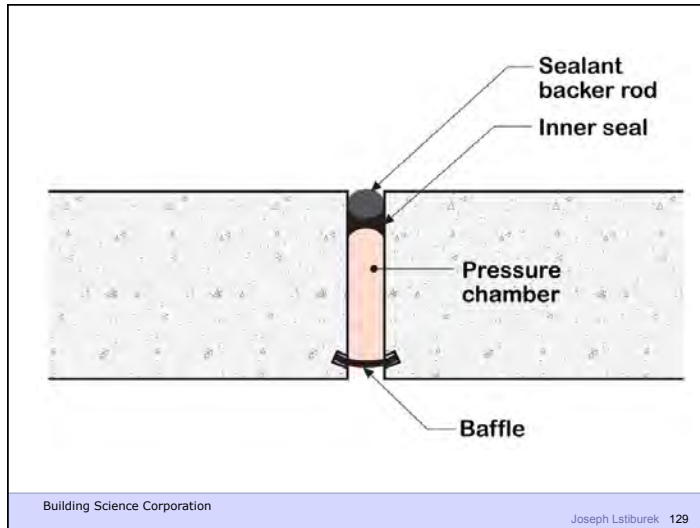

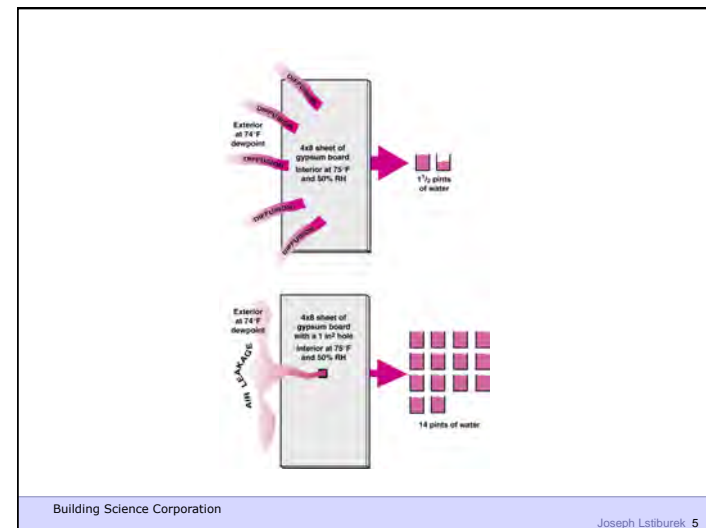
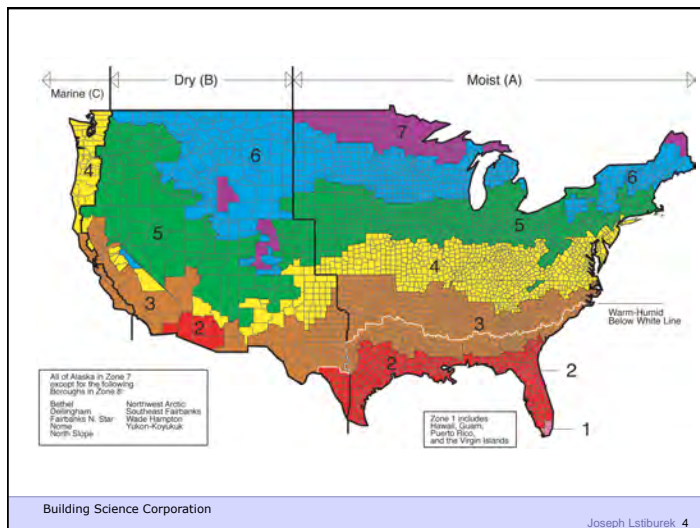
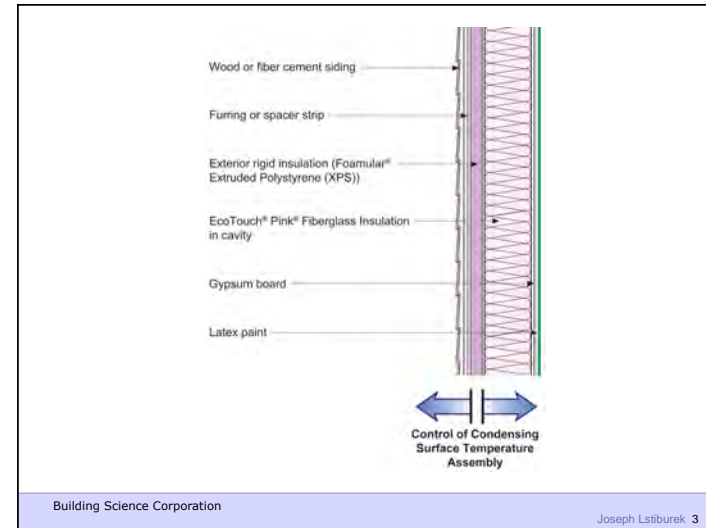
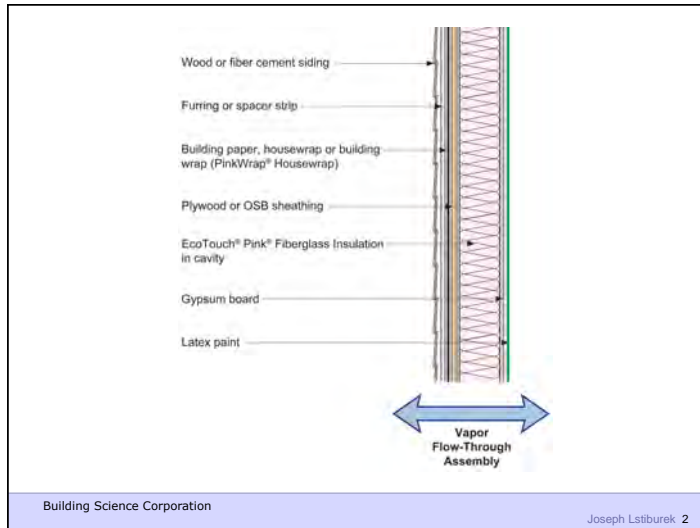

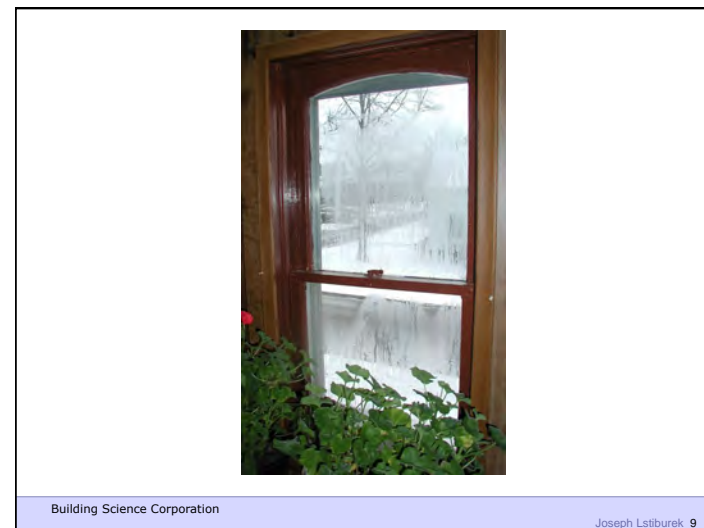
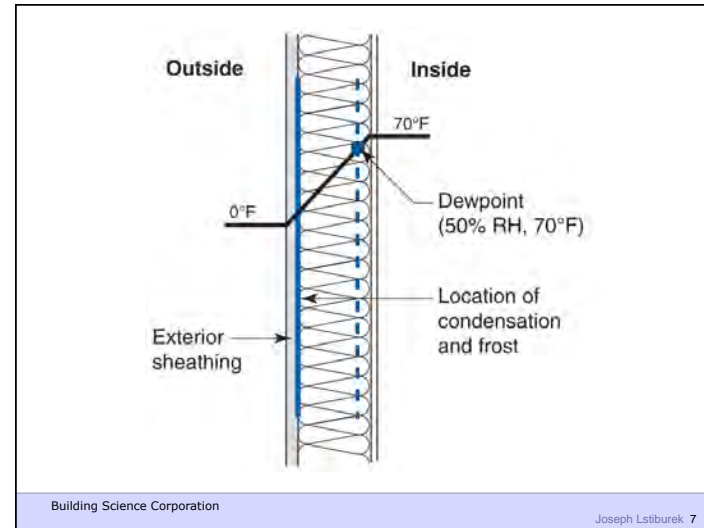
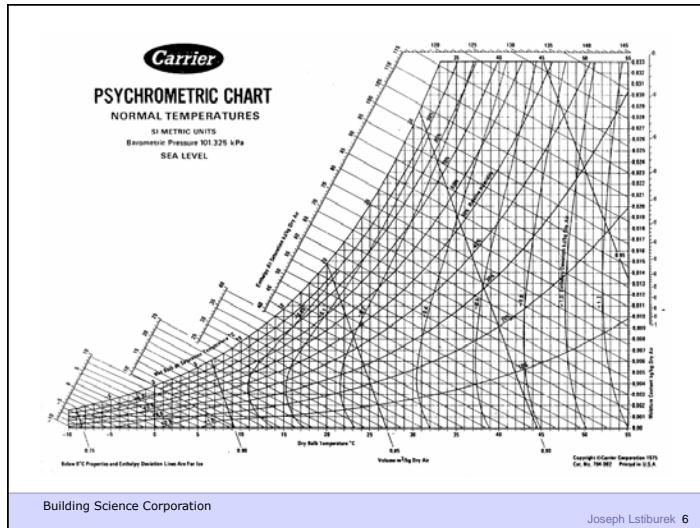

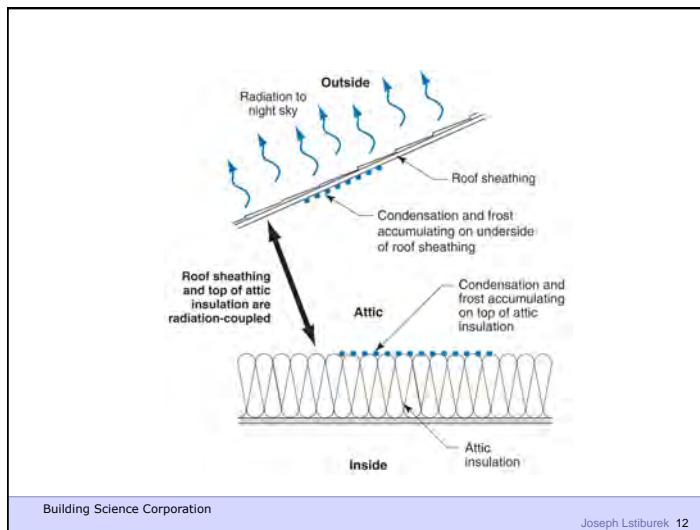
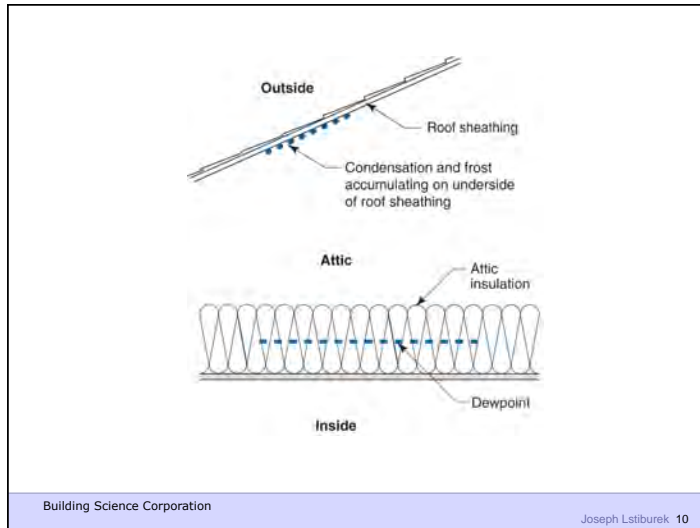



Building Science Corporation

Joseph Lstiburek 14

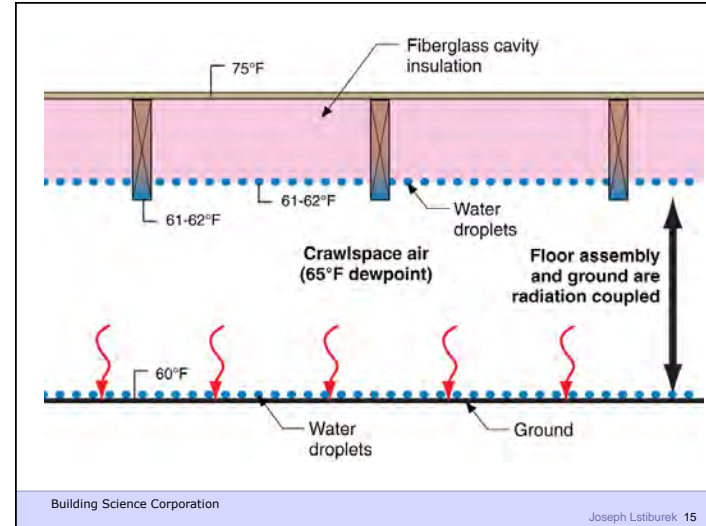

Building Science Corporation

Joseph Lstiburek 15

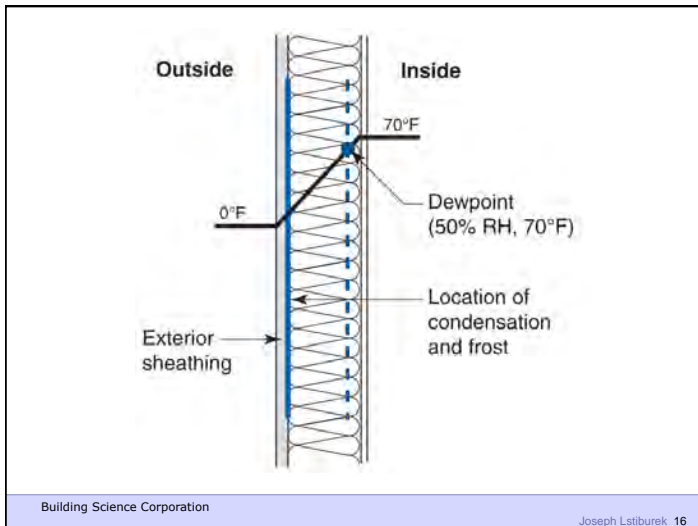

Building Science Corporation

Joseph Lstiburek 16

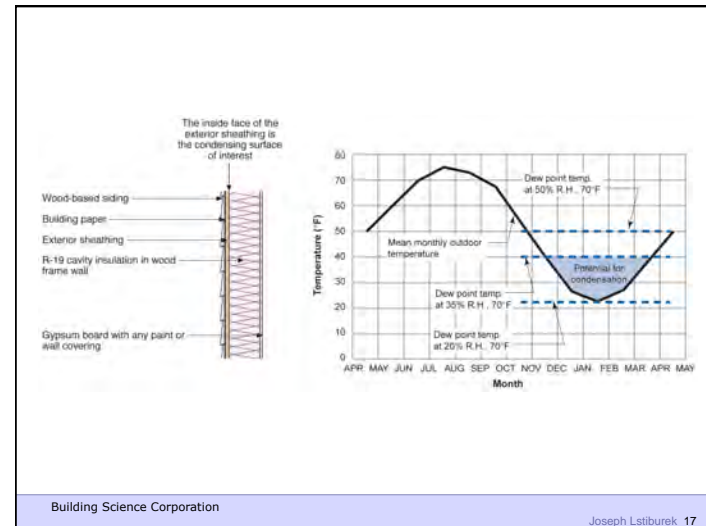

Building Science Corporation

Joseph Lstiburek 17

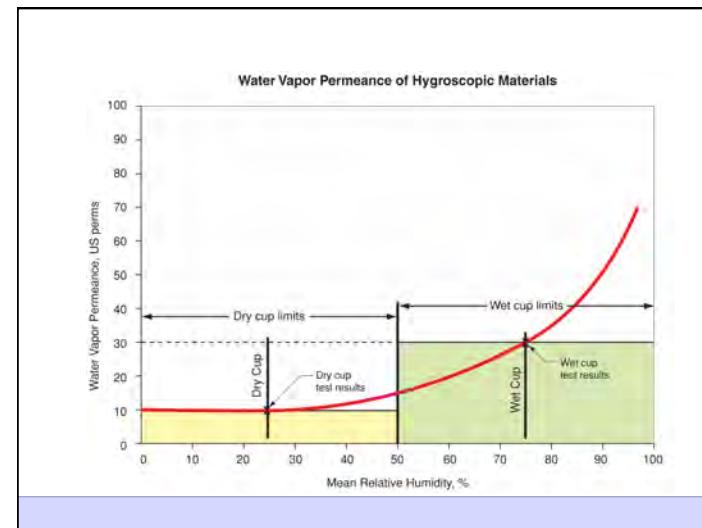
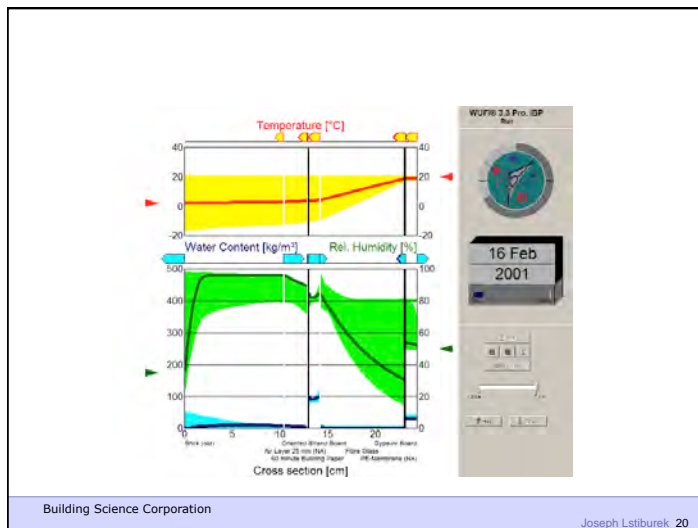
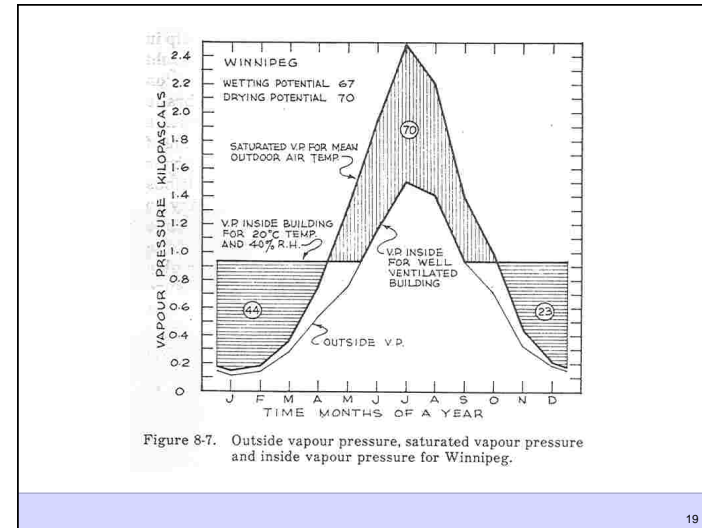
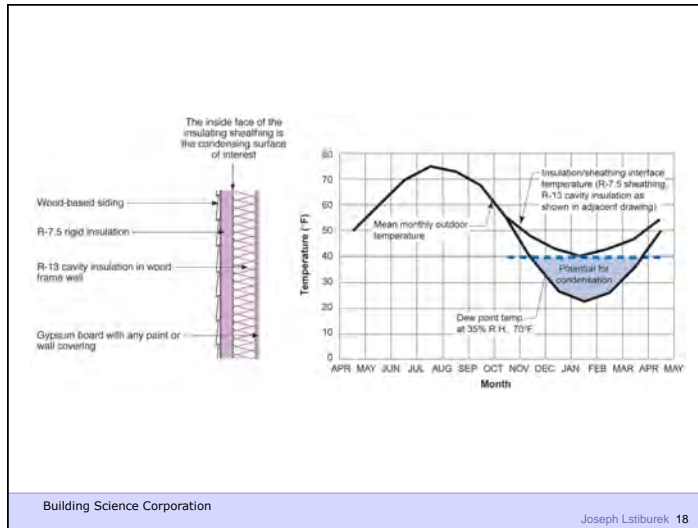

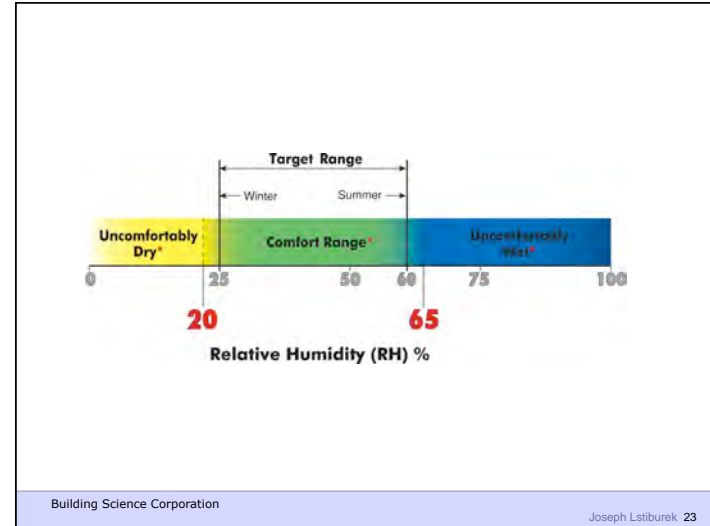
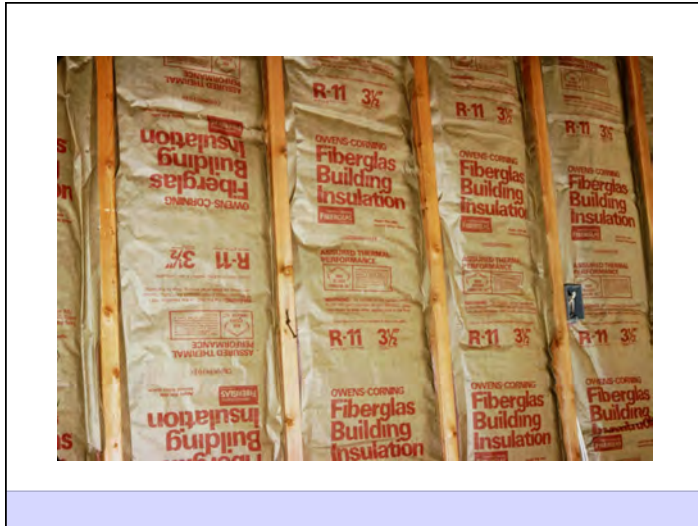

Building Science Corporation

Joseph Lstiburek 23

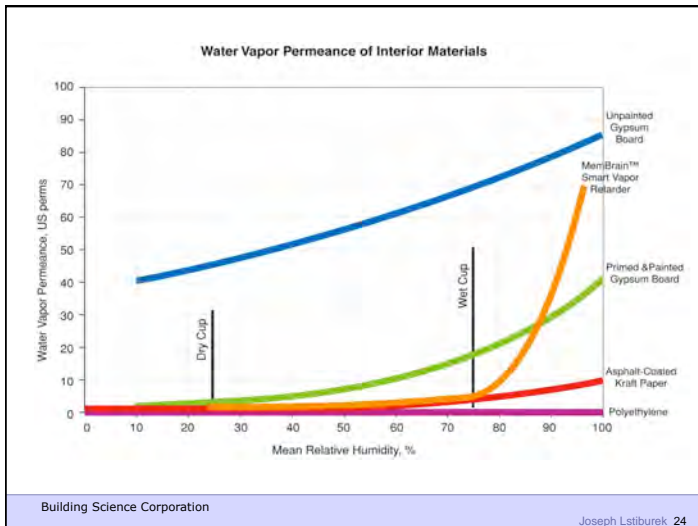

Building Science Corporation

Joseph Lstiburek 24

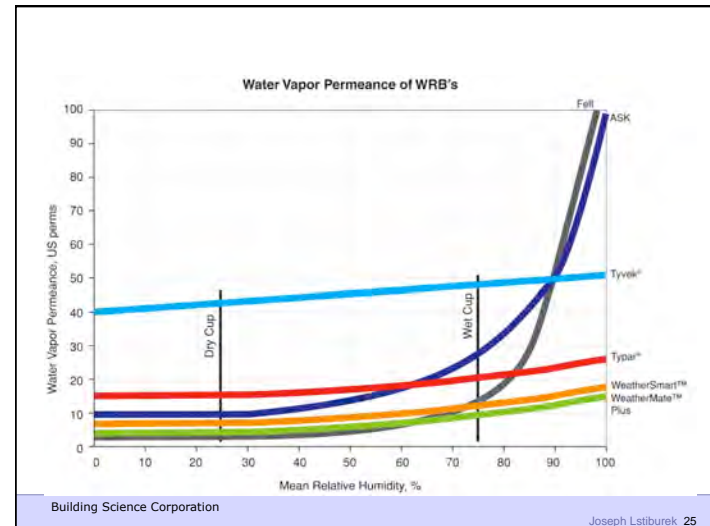

Building Science Corporation

Joseph Lstiburek 25

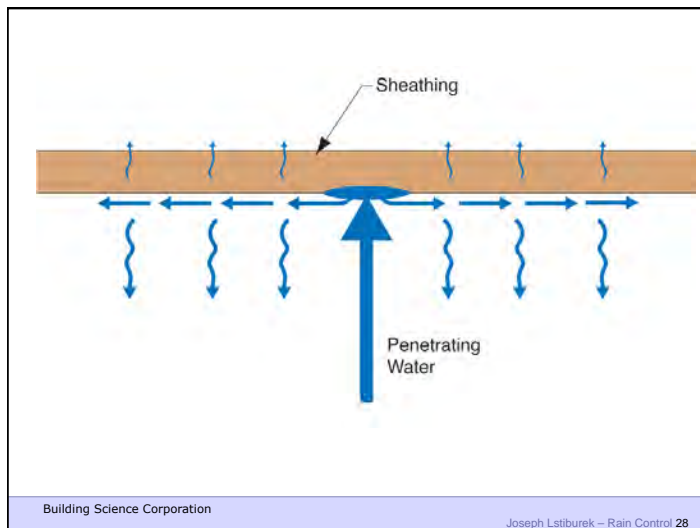
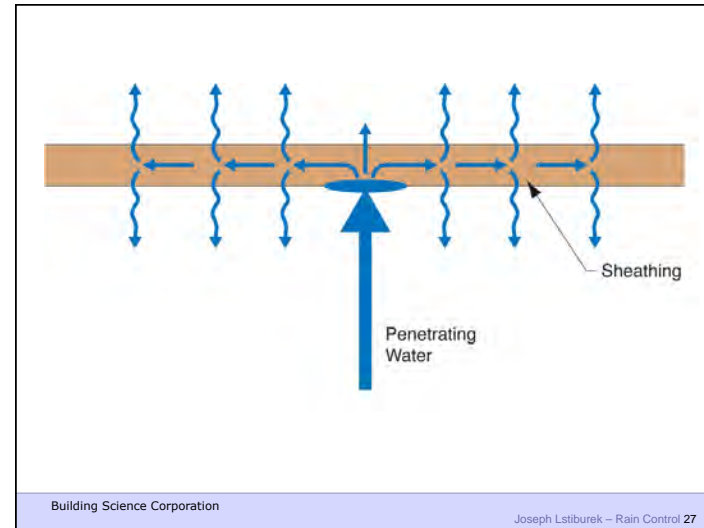
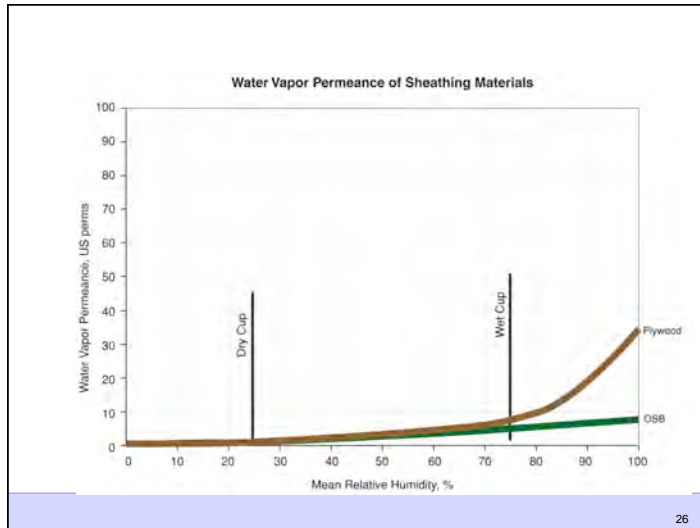

Rain Screen

Building Science Corporation

Joseph Lstiburek 30

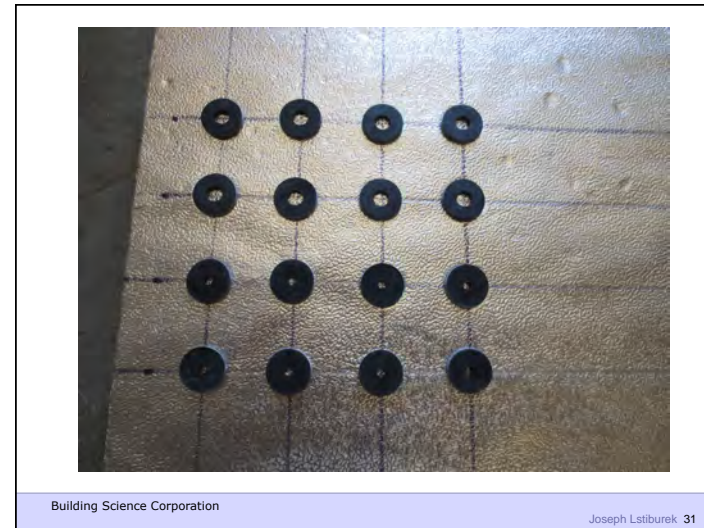

Beer Screen?

Building Science Corporation

Joseph Lstiburek 32

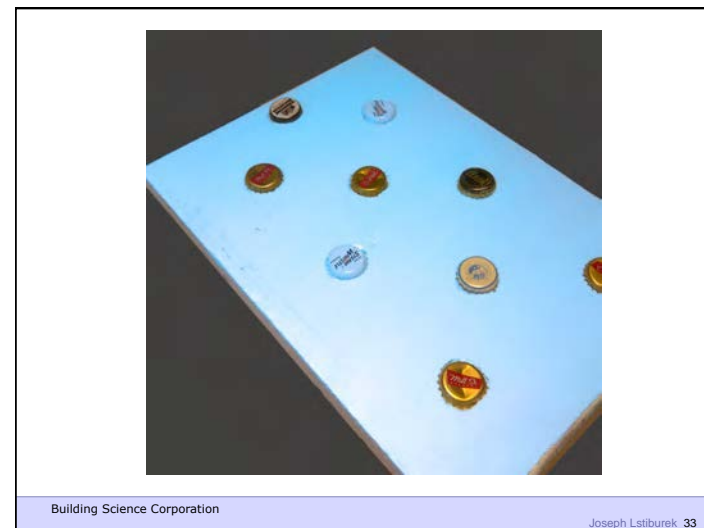

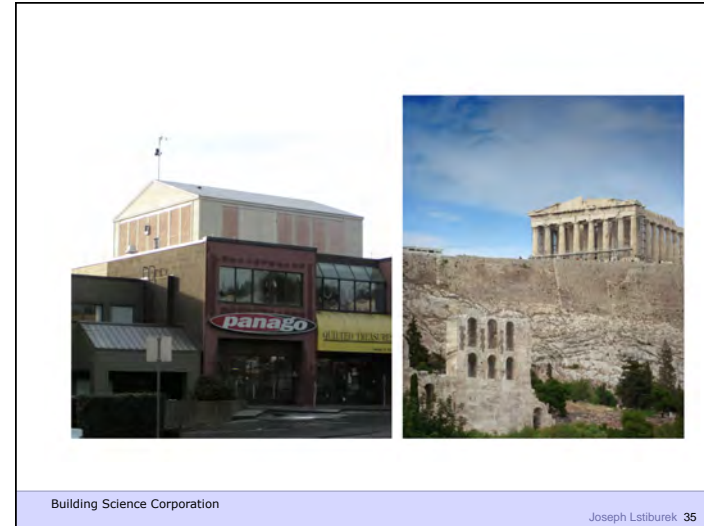
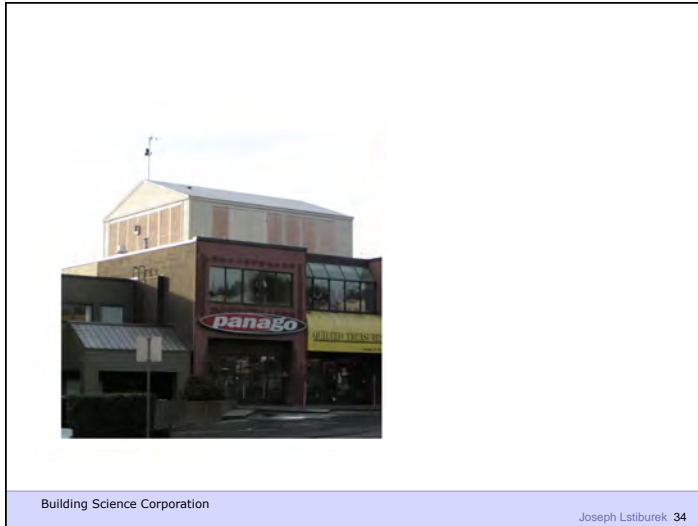



Building Science Corporation

Joseph Lstiburek 38

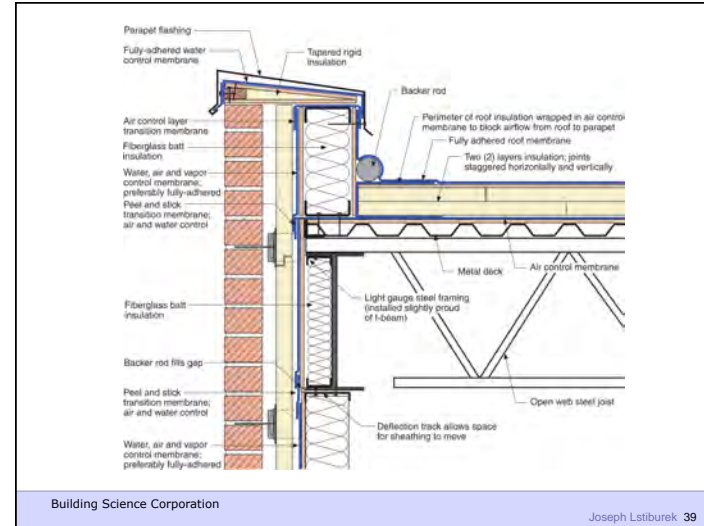

Building Science Corporation

Joseph Lstiburek 39

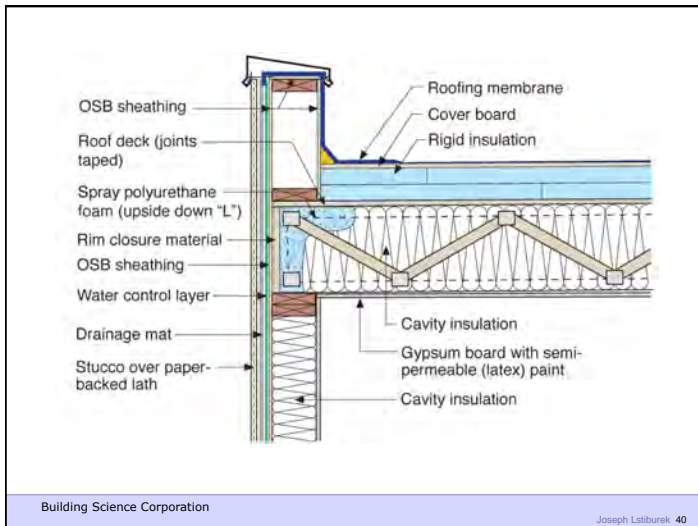

Building Science Corporation

Joseph Lstiburek 40

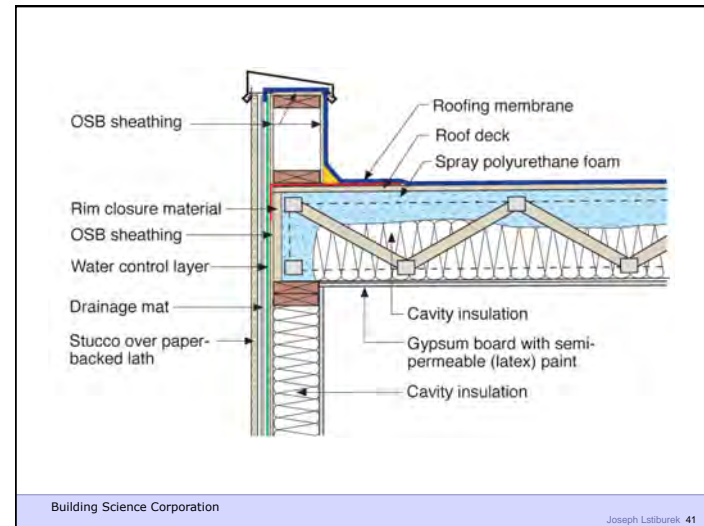

Building Science Corporation

Joseph Lstiburek 41

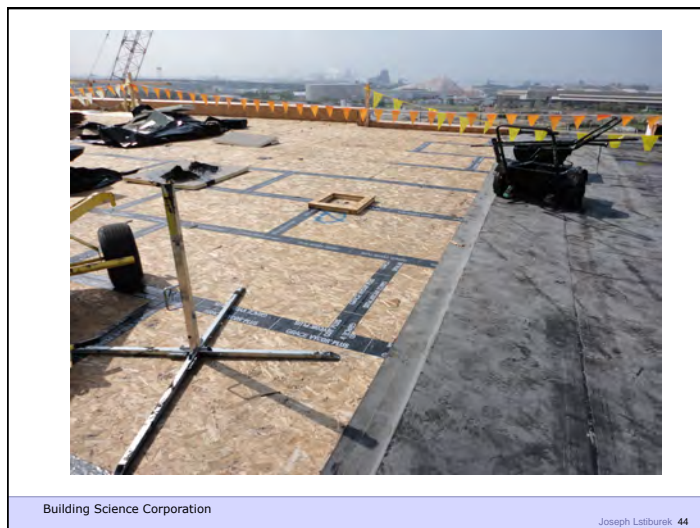
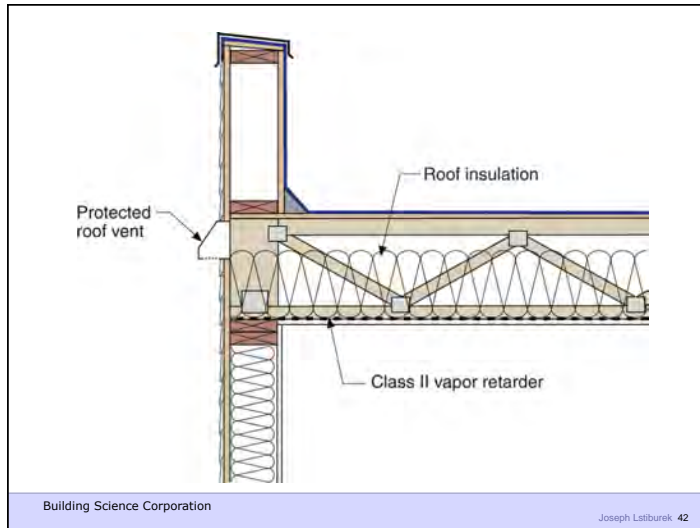

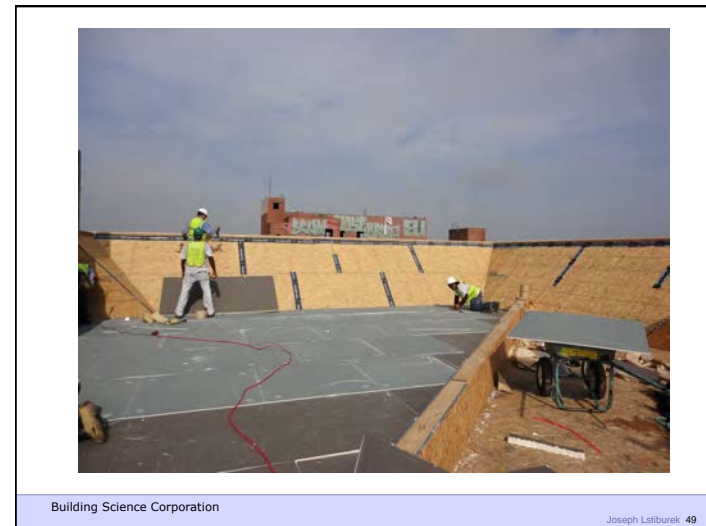
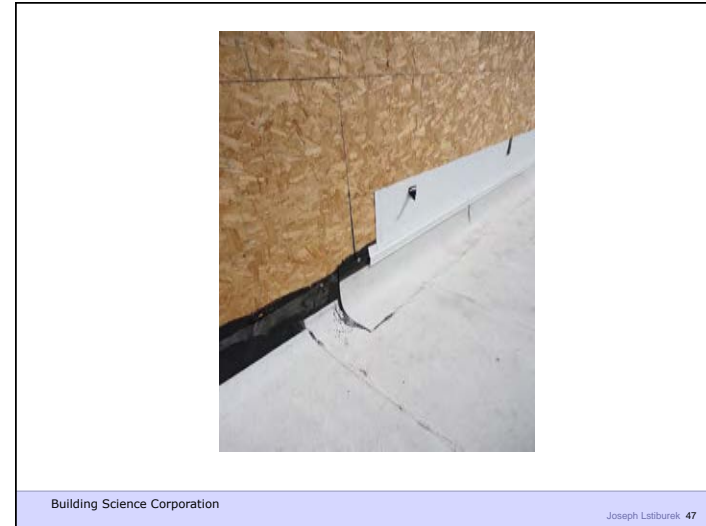
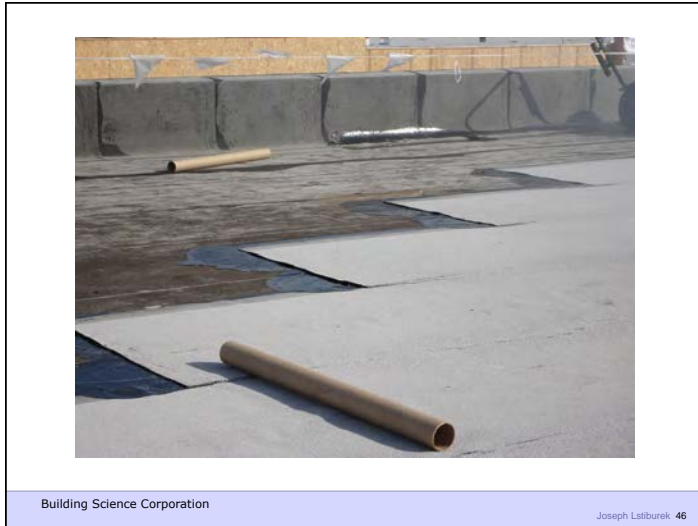

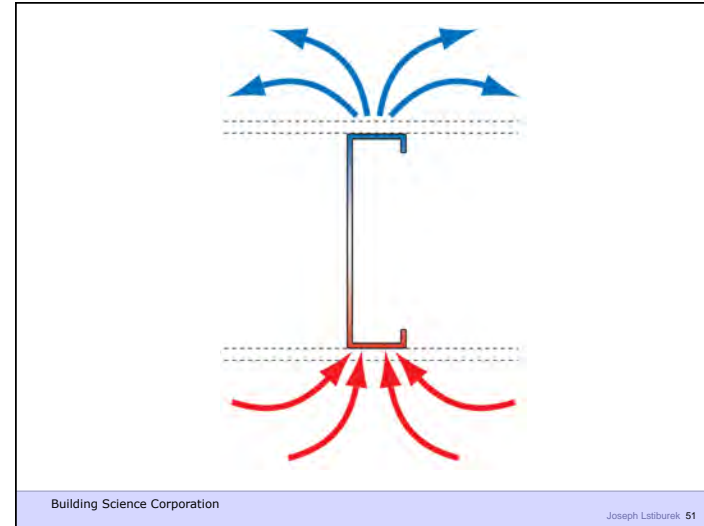
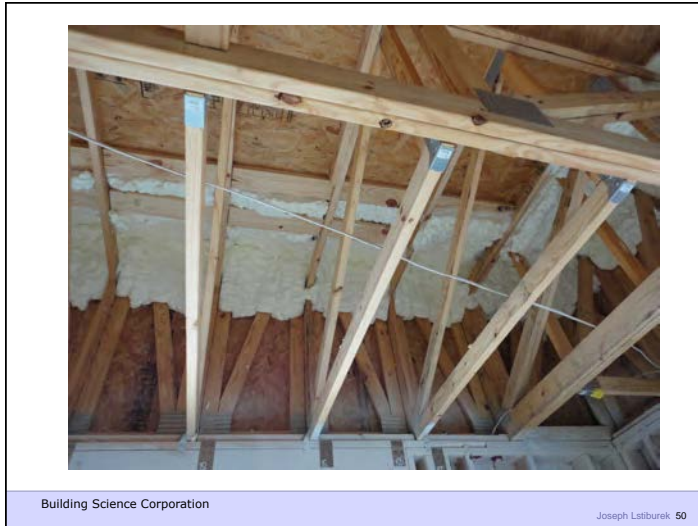

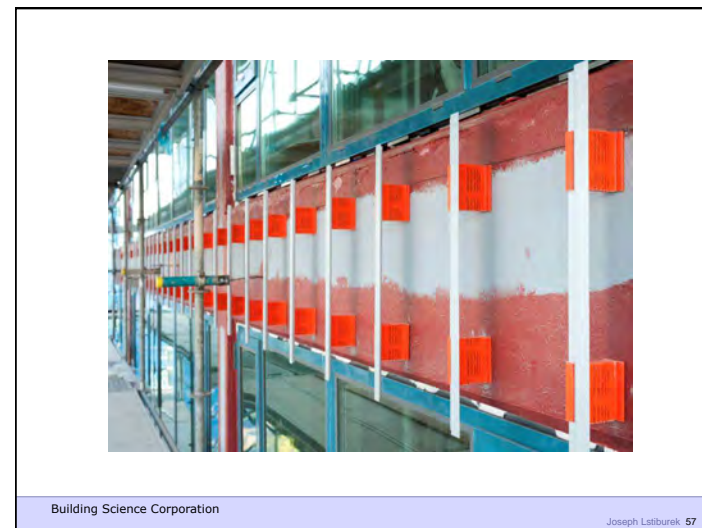
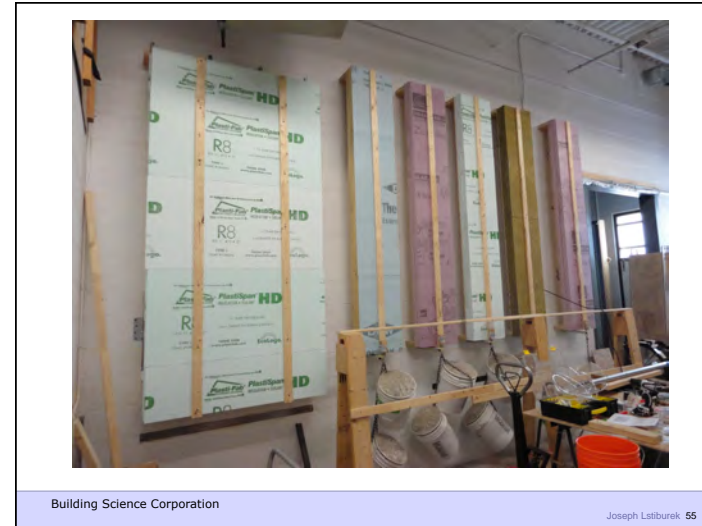

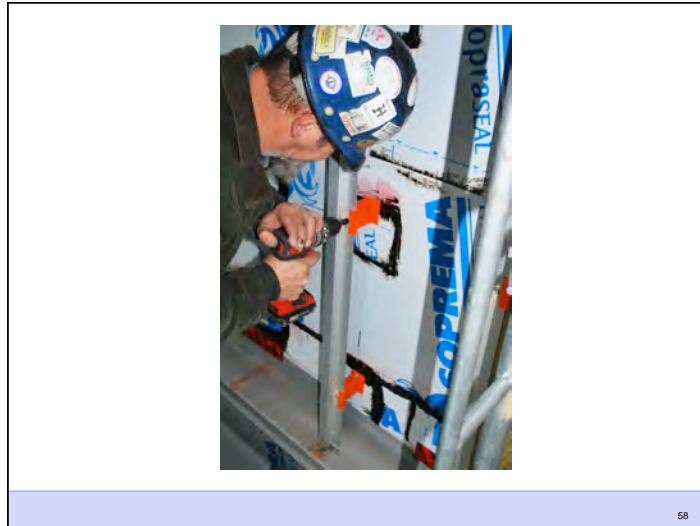

58

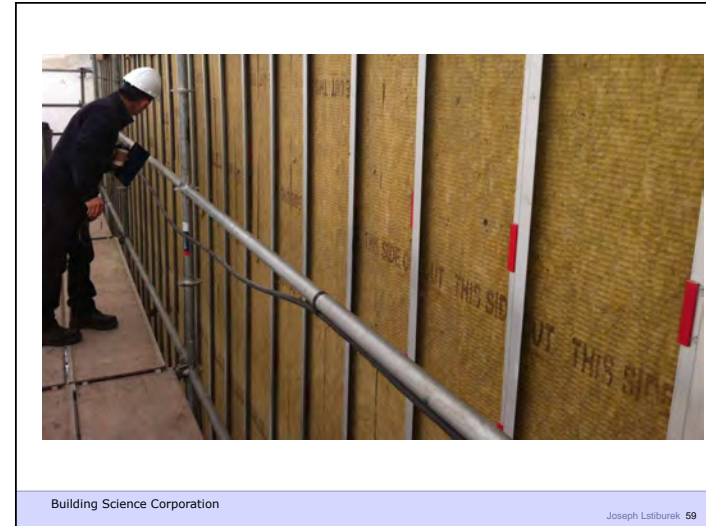

Building Science Corporation

Joseph Lstiburek 59

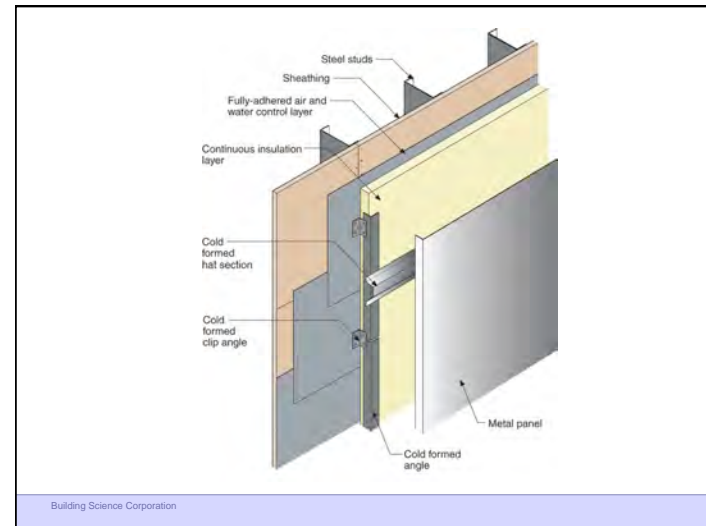
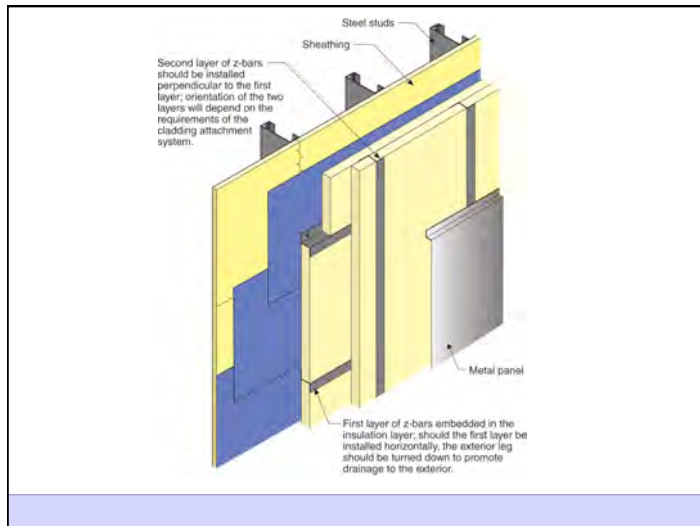

Building Science Corporation

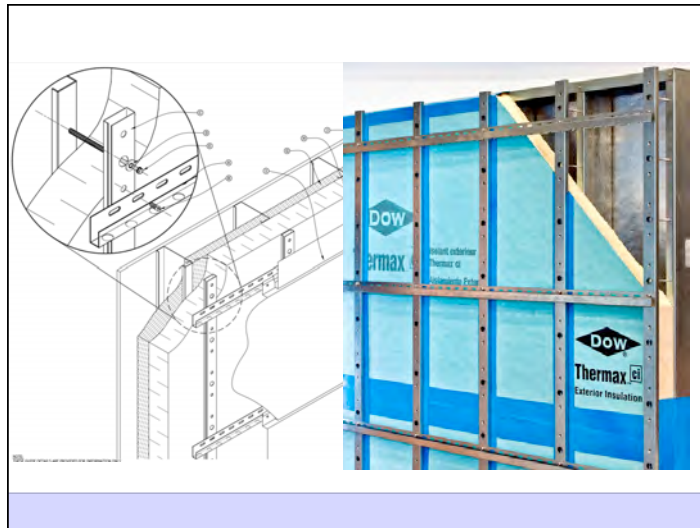

Air Barrier Metrics

Material	0.02 I/(s-m ²)@75 Pa
Assembly	0.20 I/(s-m ²)@75 Pa
Enclosure	2.00 I/(s-m ²)@75 Pa

Building Science Corporation

Joseph Lstiburek 63

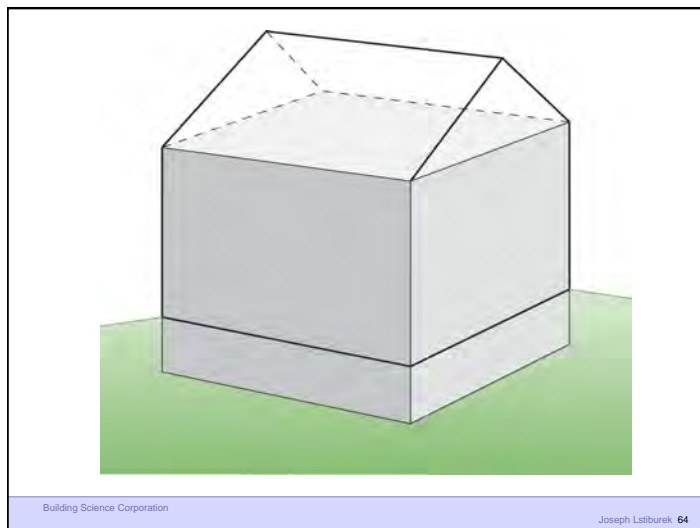

Building Science Corporation

Joseph Lstiburek 64

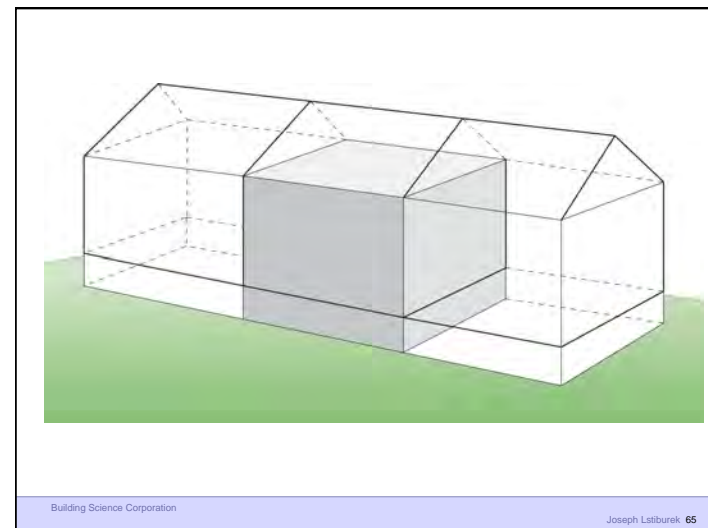

Building Science Corporation

Joseph Lstiburek 65

