

Joseph Lstiburek, Ph.D., P.Eng, ASHRAE Fellow

Building Science

Adventures In Building Science

www.buildingscience.com

Handouts can be downloaded from:
www.buildingscience.com

Building Science Corporation
2011

Joseph Lstiburek 2

1. Environmental Separation

Building Science Corporation
2011



Joseph Lstiburek 3

R2



Building Science Corporation
2011

Joseph Lstiburek 4

R2  **R4** 





Building Science Corporation
2011

Joseph Lstiburek 5

R2  **R4**  **R6** 





Building Science Corporation
2011

Joseph Lstiburek 6

R2  **R4**  **R6**  **R8** 

Building Science Corporation
2011

Joseph Lstiburek 7

R2  **R4**  **R6**  **R8** 

R8 

Building Science Corporation
2011

Joseph Lstiburek 8

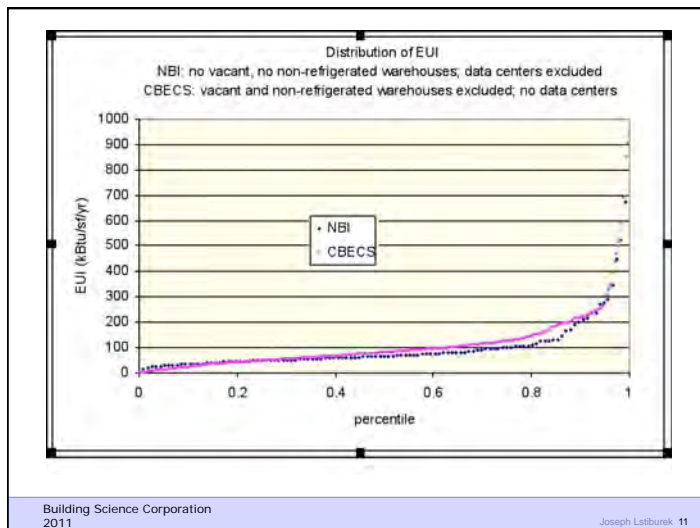
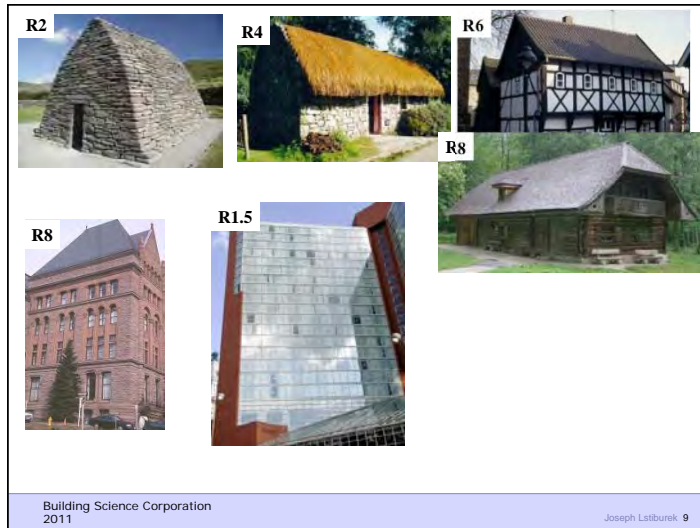

Life is Tough Enough As it Is...

Building Science Corporation
2011

Joseph Lstiburek 13

Life is Tough Enough As it Is...
It's Harder When You Are Stupid

Building Science Corporation
2011

Joseph Lstiburek 14

Don't Do Stupid Things

Building Science Corporation
2011

Joseph Lstiburek 15

What is a Building?

Building Science Corporation
2011

Joseph Lstiburek 16

What is a Building?
It is an Environmental Separator

Building Science Corporation
2011

Joseph Lstiburek 17

- Control heat flow
- Control airflow
- Control water vapor flow
- Control rain
- Control ground water
- Control light and solar radiation
- Control noise and vibrations
- Control contaminants, environmental hazards and odors
- Control insects, rodents and vermin
- Control fire
- Provide strength and rigidity
- Be durable
- Be aesthetically pleasing
- Be economical

Building Science Corporation
2011

Joseph Lstiburek 18

Not all performance objectives are equal.
Our focus is control of heat, air and moisture.

Building Science Corporation
2011

Joseph Lstiburek 19

Damage Functions
Water, Heat and Ultra-Violet Radiation

Building Science Corporation
2011

Joseph Lstiburek 20

Heat Flow Is From Warm To Cold
 Moisture Flow Is From Warm To Cold
 Moisture Flow Is From More To Less
 Air Flow Is From A Higher Pressure to a Lower Pressure
 Gravity Acts Down

Building Science Corporation
 2011

Joseph Lstiburek 21



Building Science Corporation
 2011

Joseph Lstiburek 22

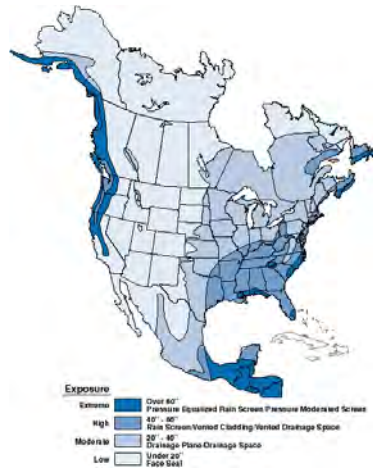

Building Science Corporation
 2011

Joseph Lstiburek 23

Water Control Layer
 Air Control Layer
 Vapor Control Layer
 Thermal Control Layer

Building Science Corporation
 2011

Joseph Lstiburek 24

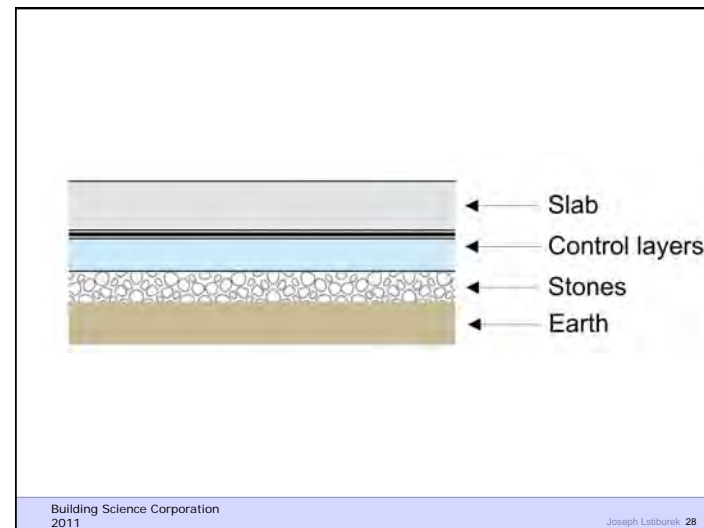
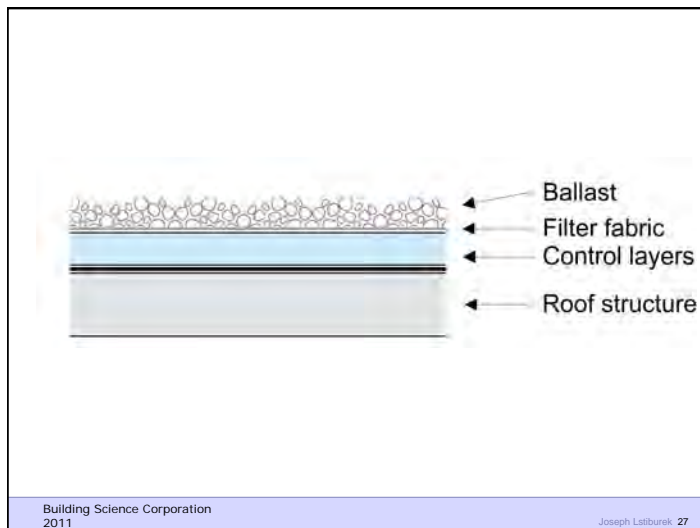
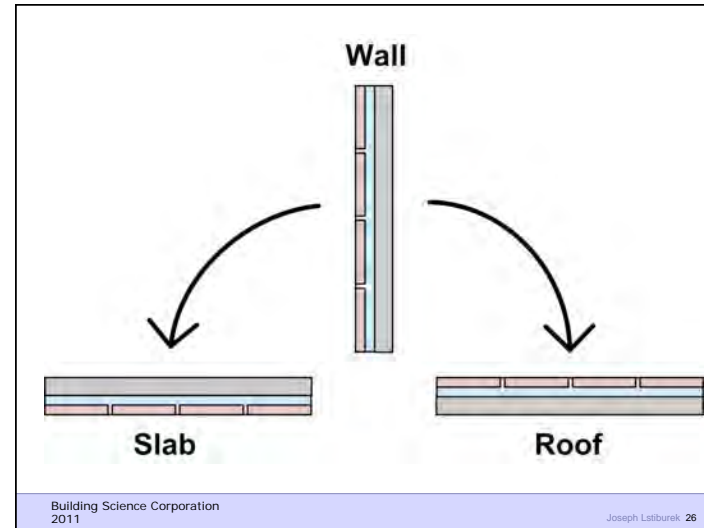
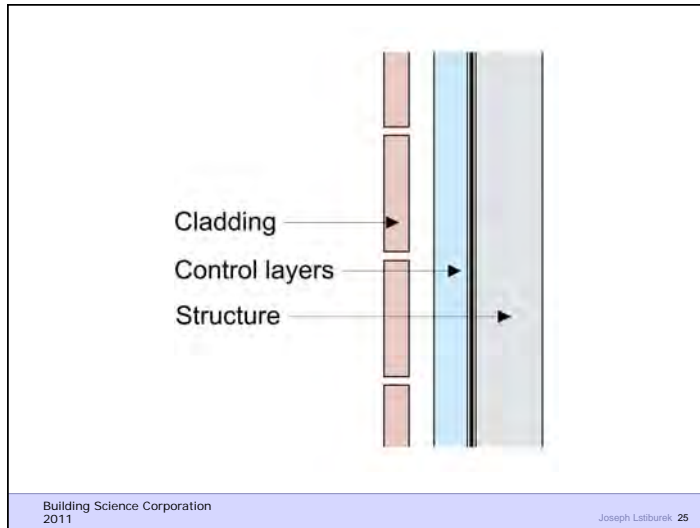

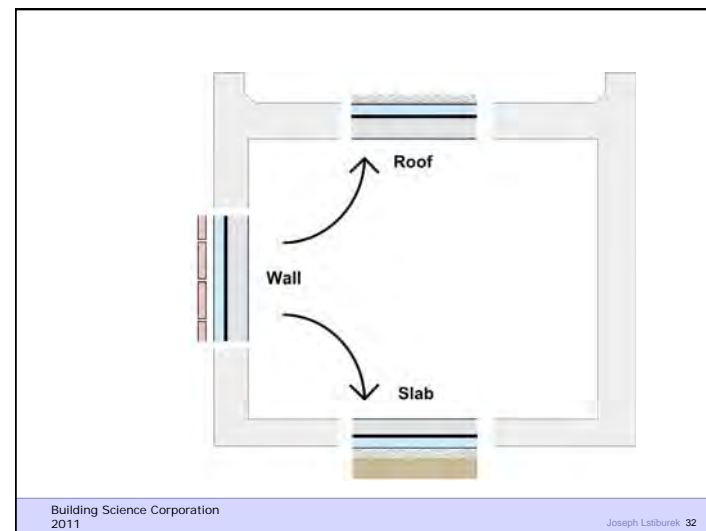
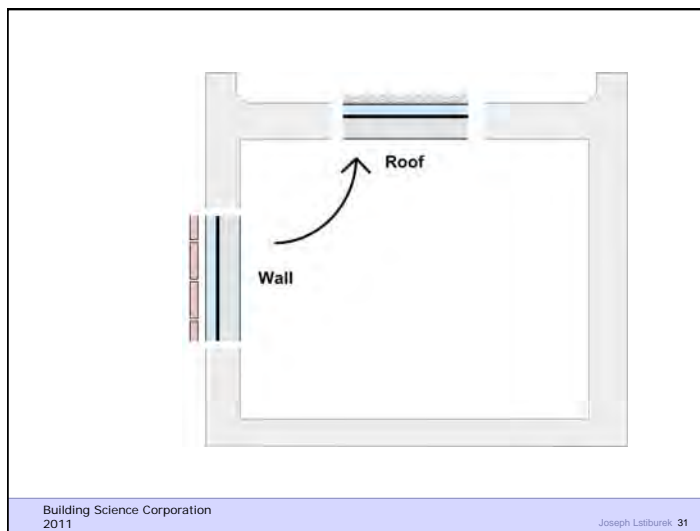
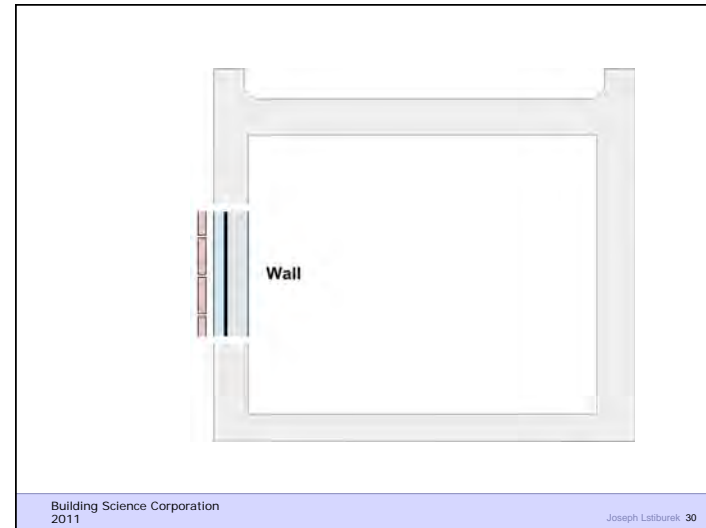
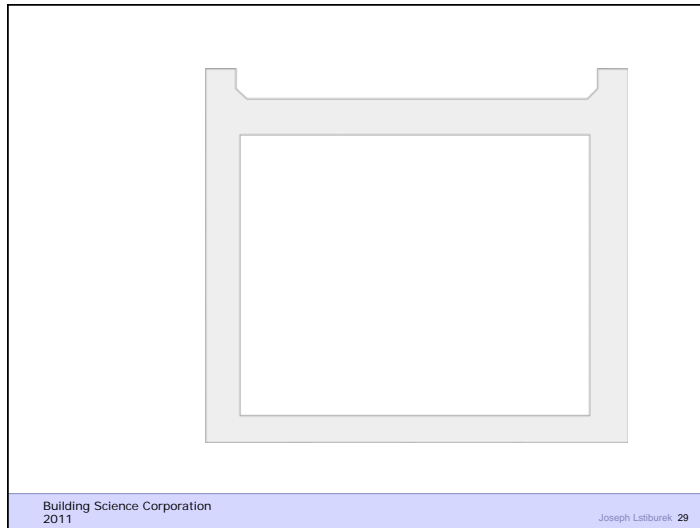

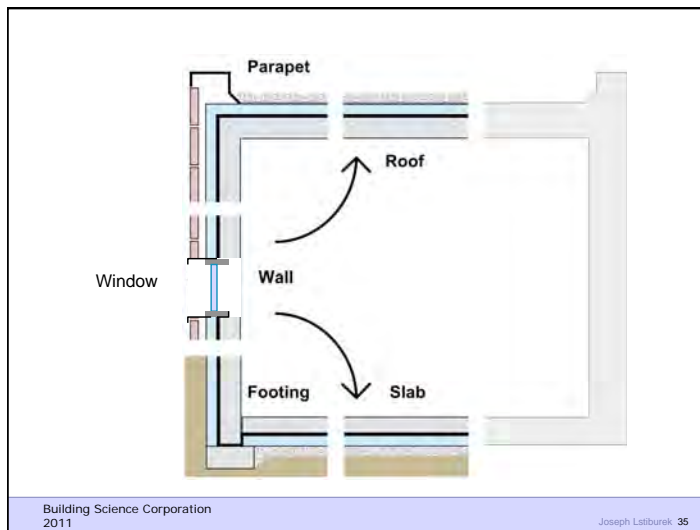
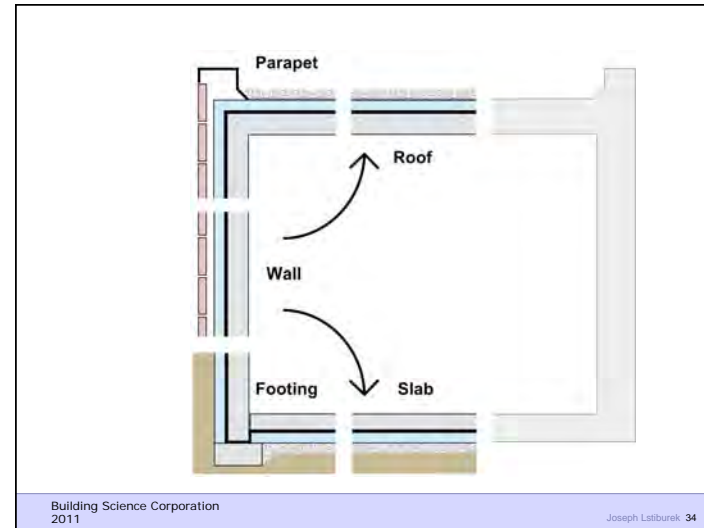
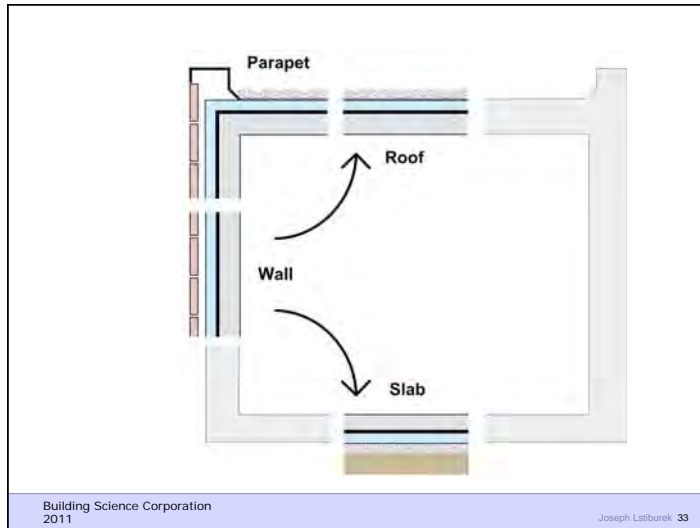

Enclosure Design: Details

- Details demand the same approach as the enclosure.
- Scaled drawings required at 

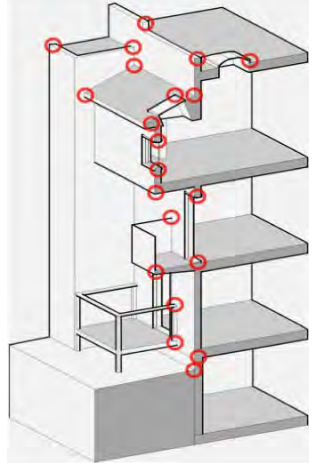

A 3D exploded view of a building enclosure, showing the roof, walls, and floor. Red circles are placed at various points of detail, such as the roof edge, window frame, and floor junctions, indicating where scaled drawings are required.

Building Science Corporation
2011

Joseph Lstiburek 36

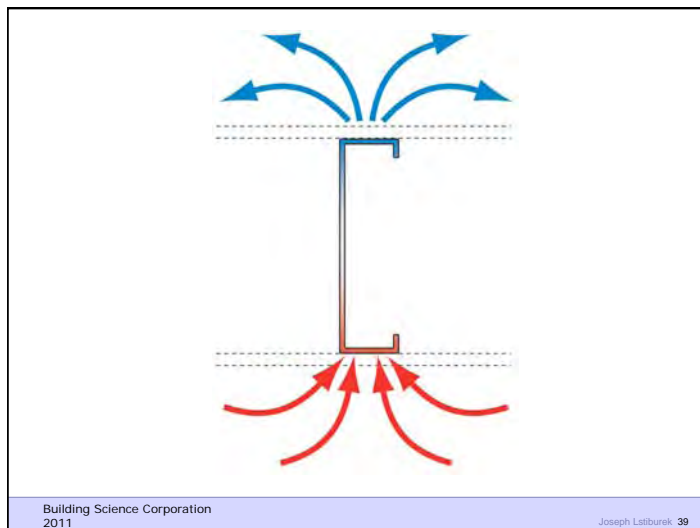
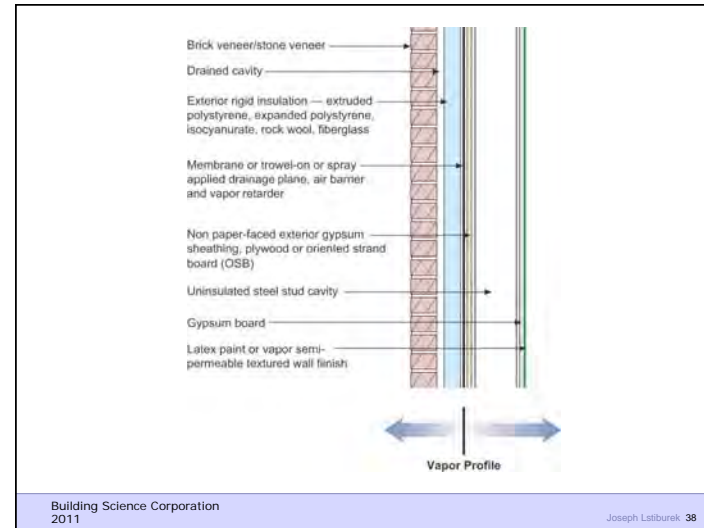
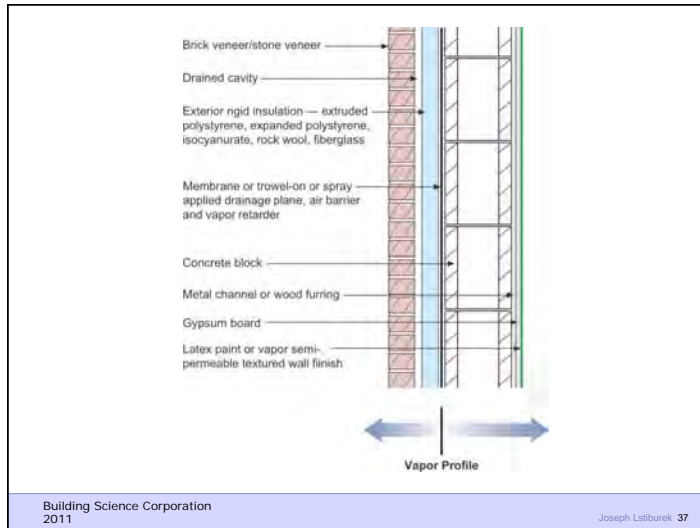

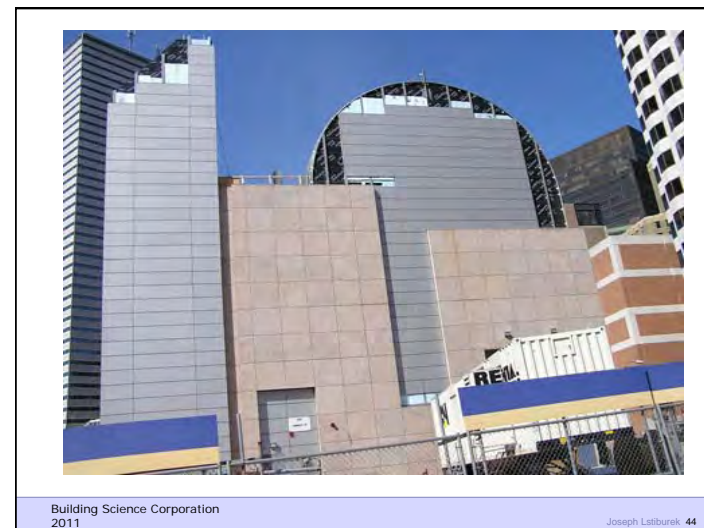
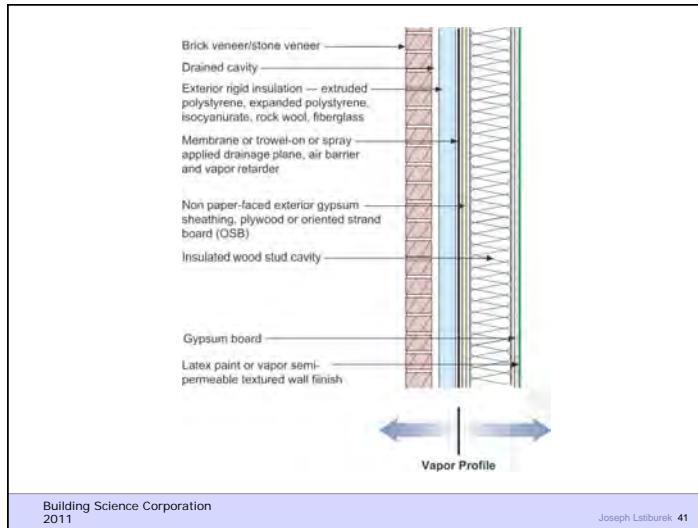

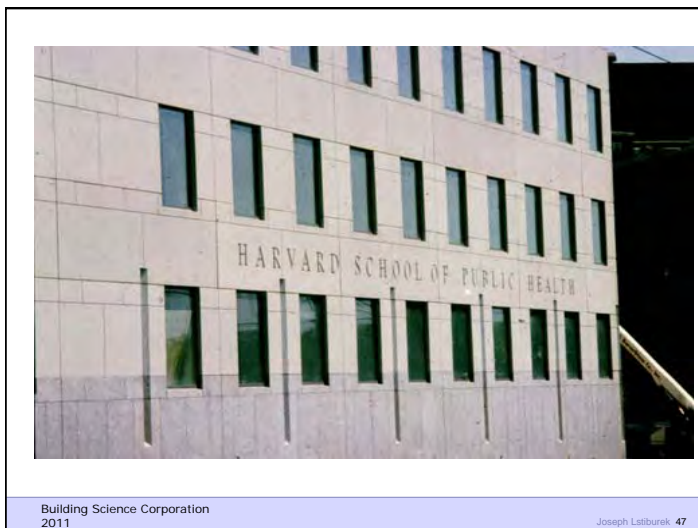
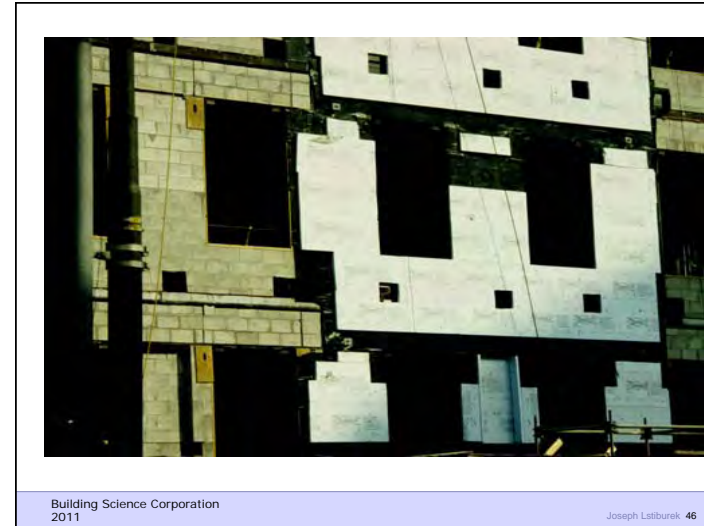

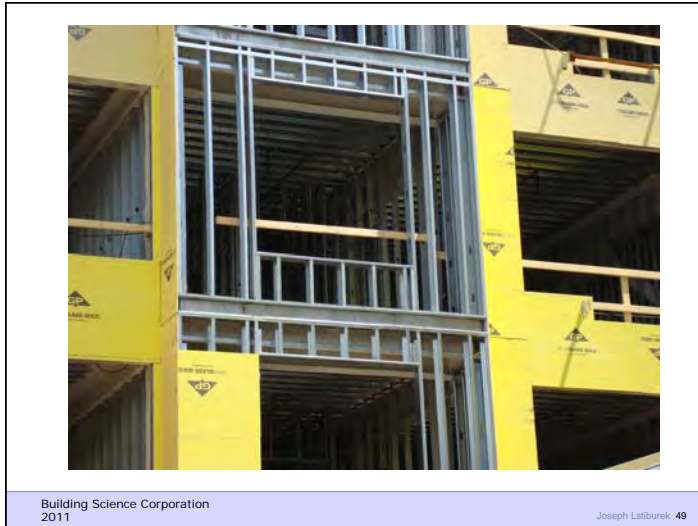

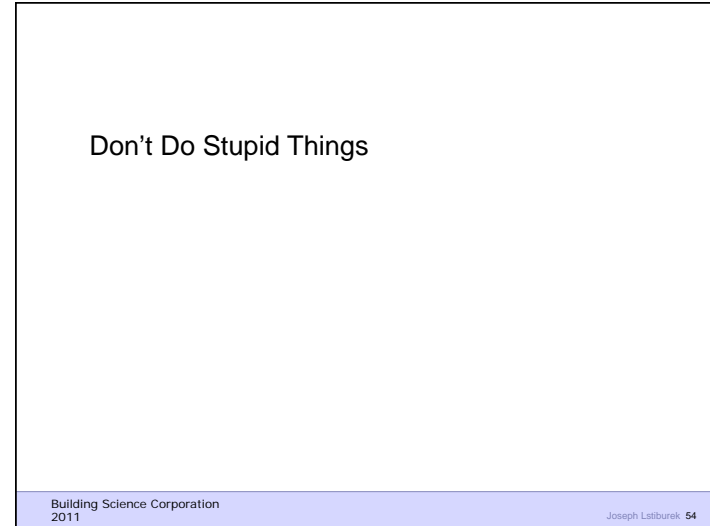

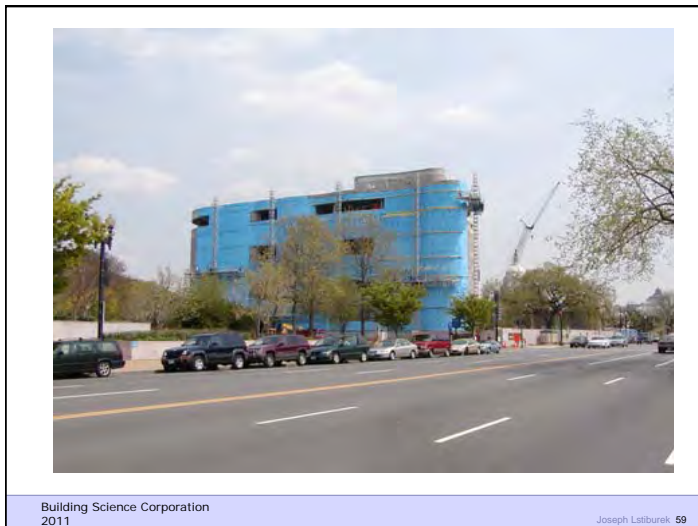

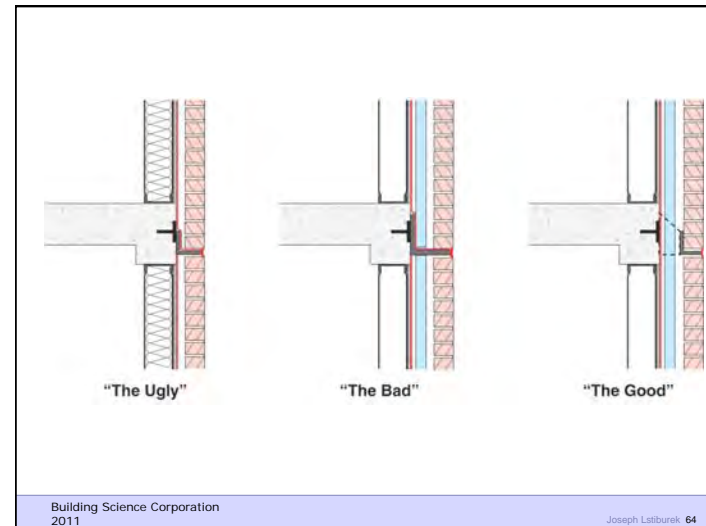
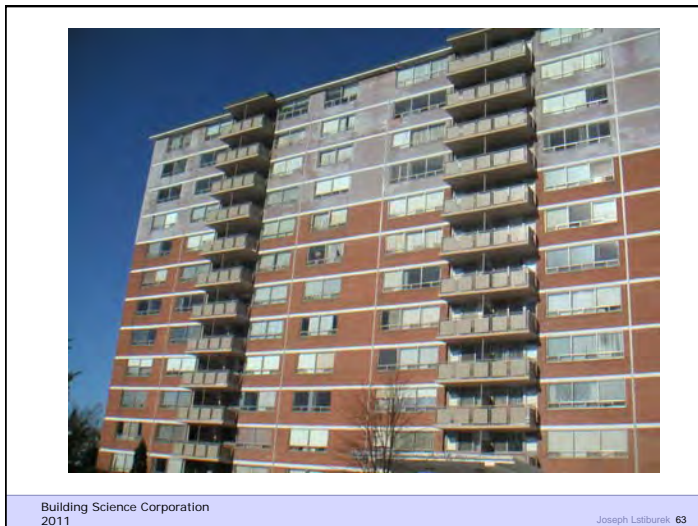

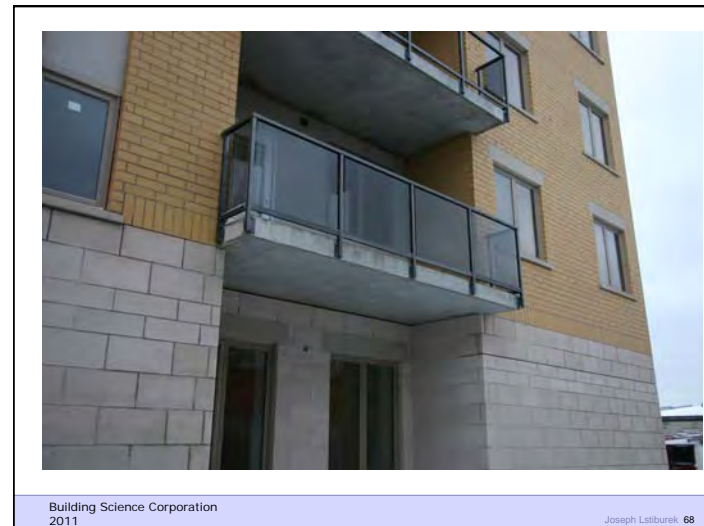
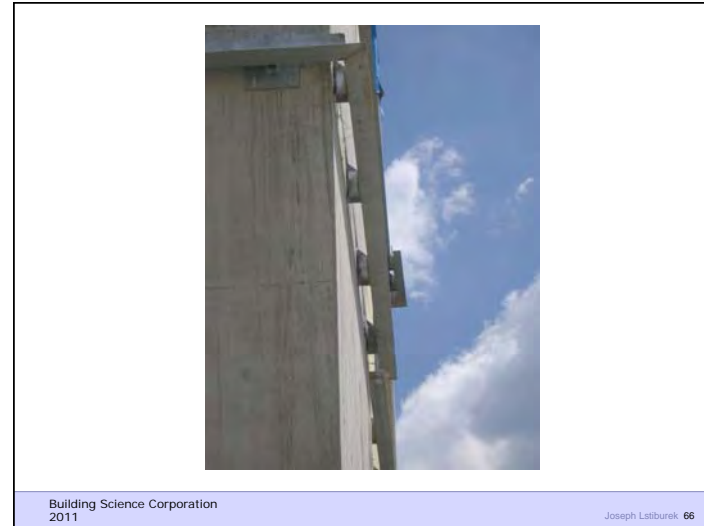

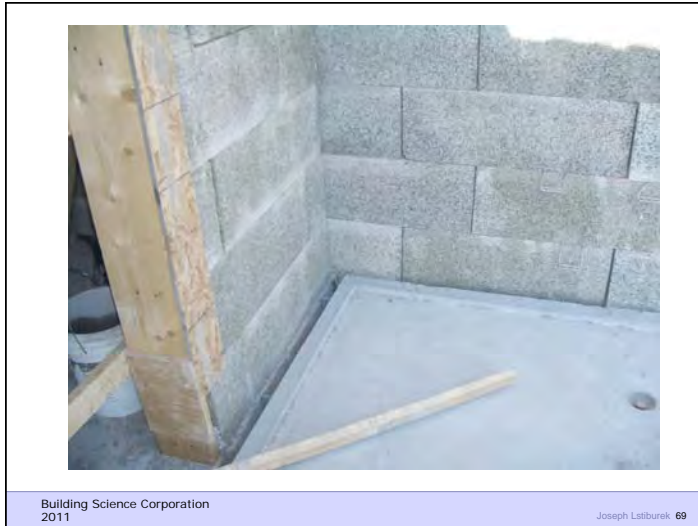

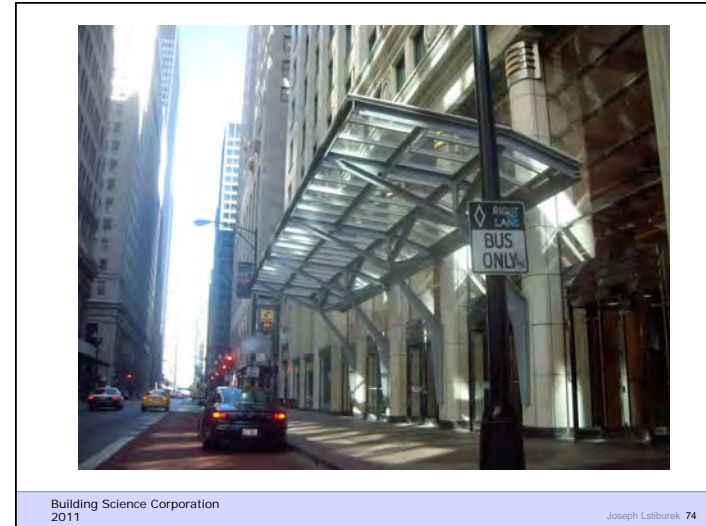
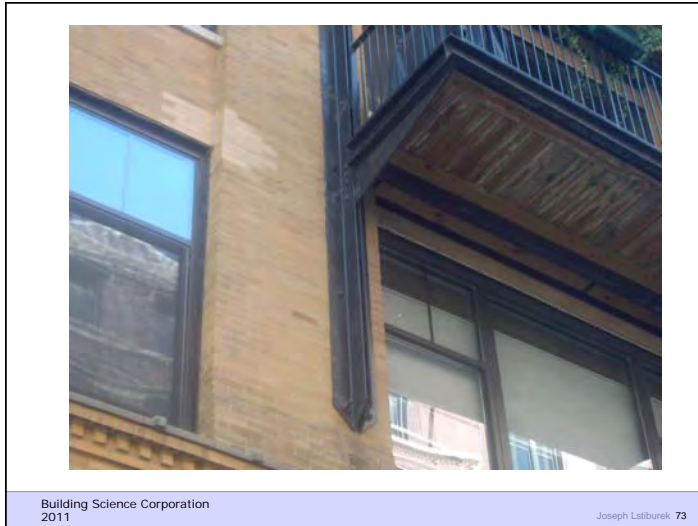

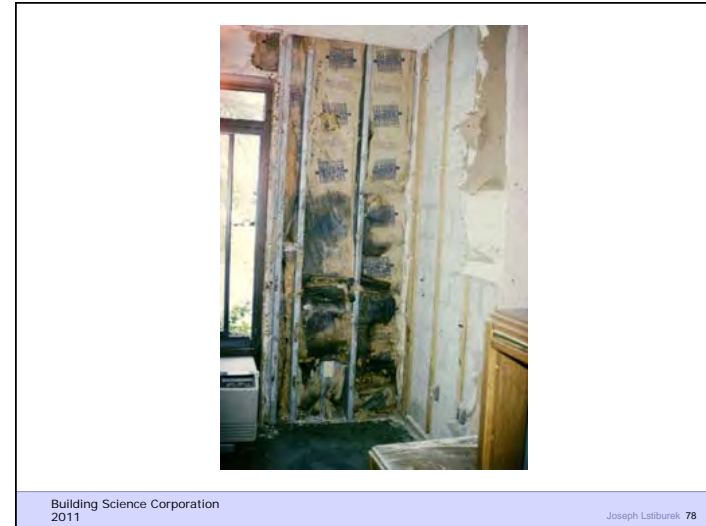
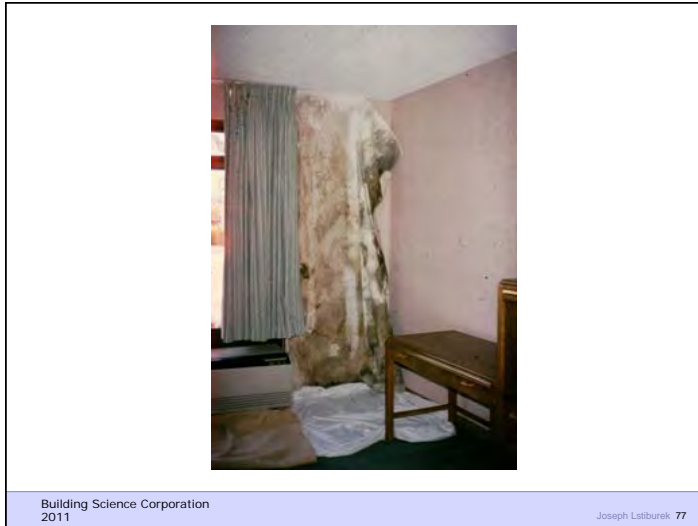



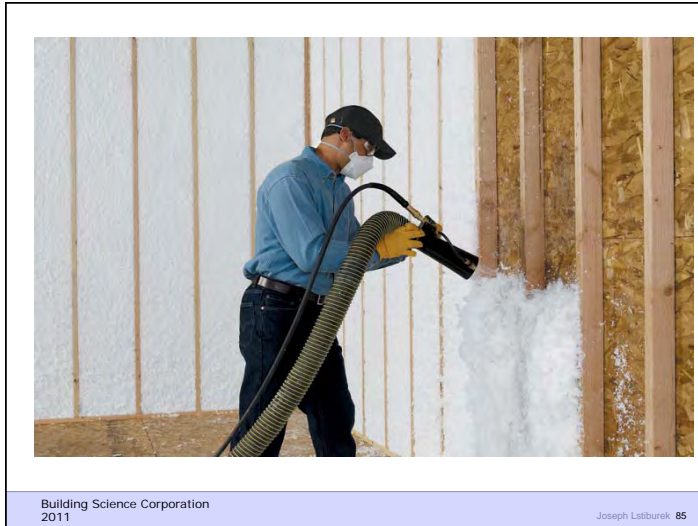

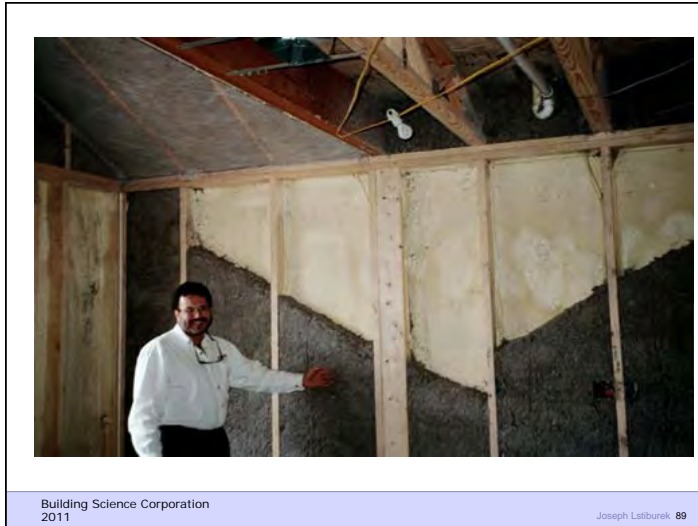

Building Science Corporation
2011

Joseph Lstiburek 89

Air Barrier Metrics

Material	0.02 l/(s-m ²)@75 Pa
Assembly	0.20 l/(s-m ²)@75 Pa
Enclosure	2.00 l/(s-m ²)@75 Pa

Building Science Corporation
2011

Joseph Lstiburek 90

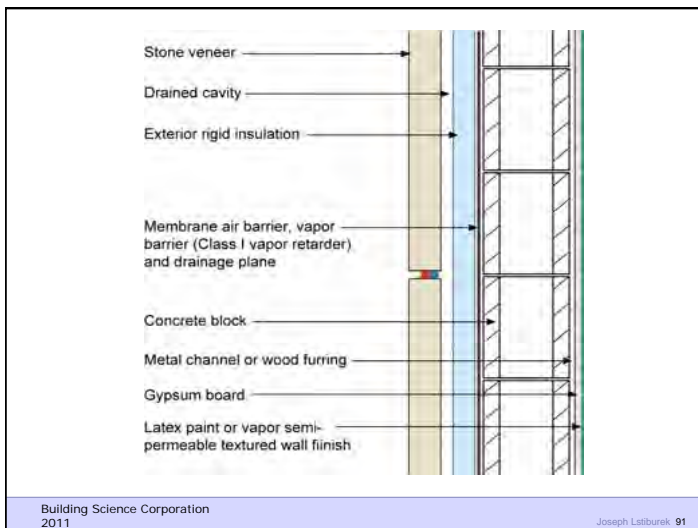

Building Science Corporation
2011

Joseph Lstiburek 91



Building Science Corporation
2011

Joseph Lstiburek 92



Building Science Corporation
2011

Joseph Lstiburek 93

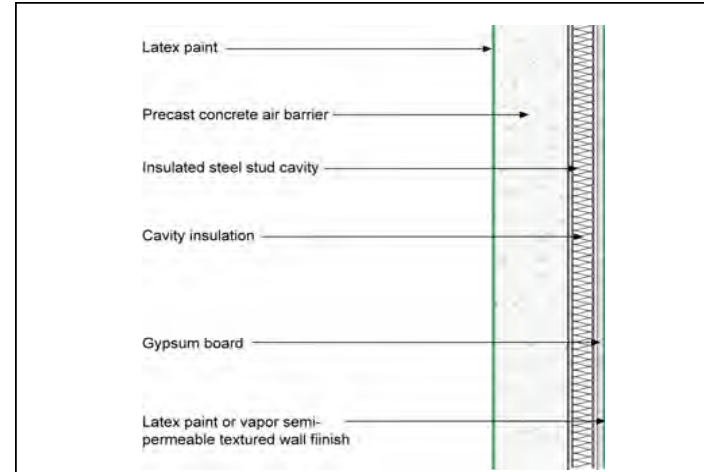

Building Science Corporation
2011

Joseph Lstiburek 94



Building Science Corporation
2011

Joseph Lstiburek 95

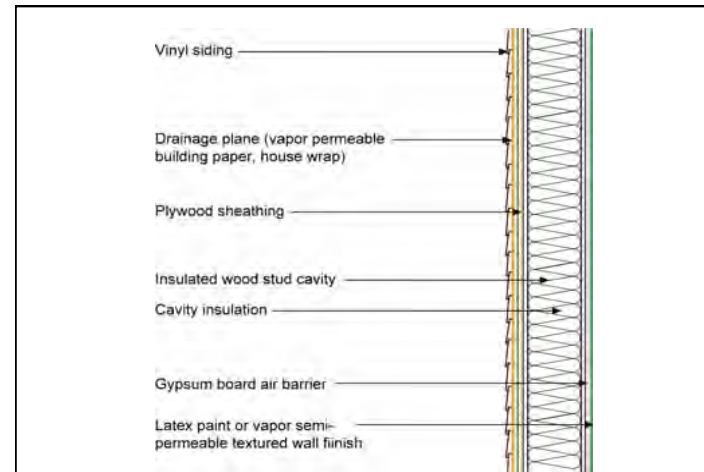

Building Science Corporation
2011

Joseph Lstiburek 96

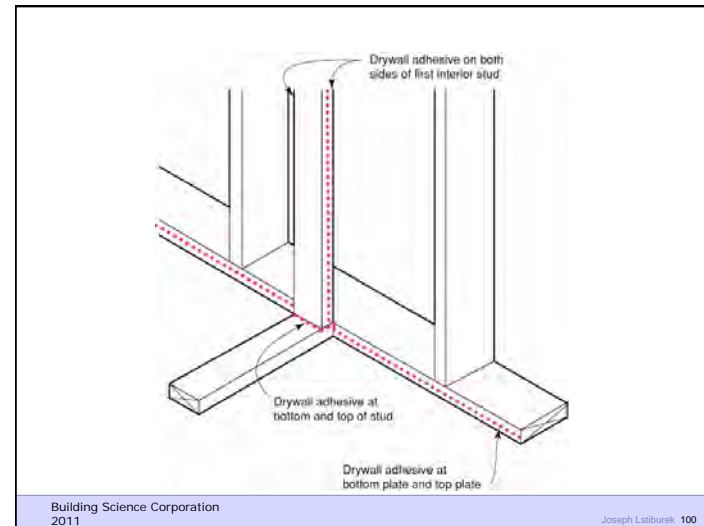
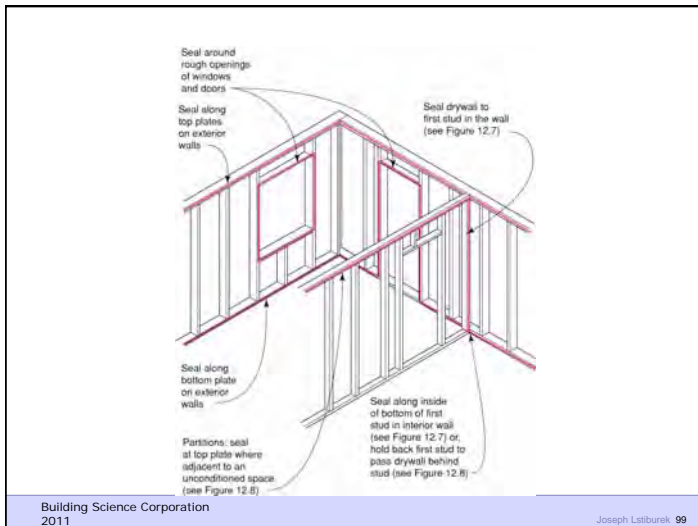
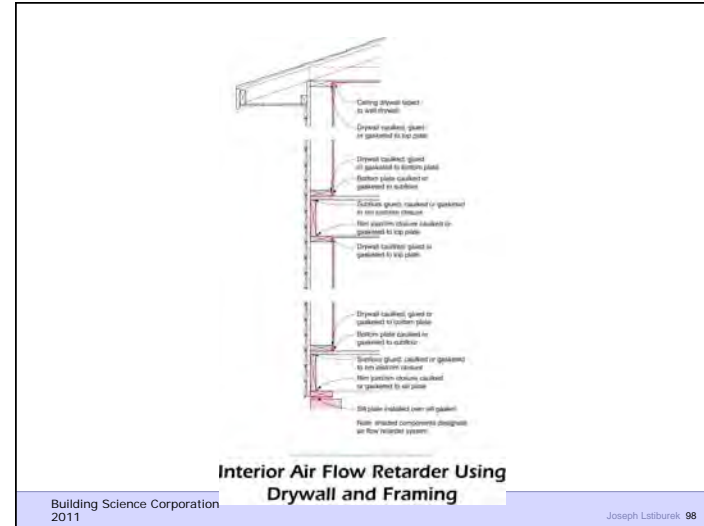

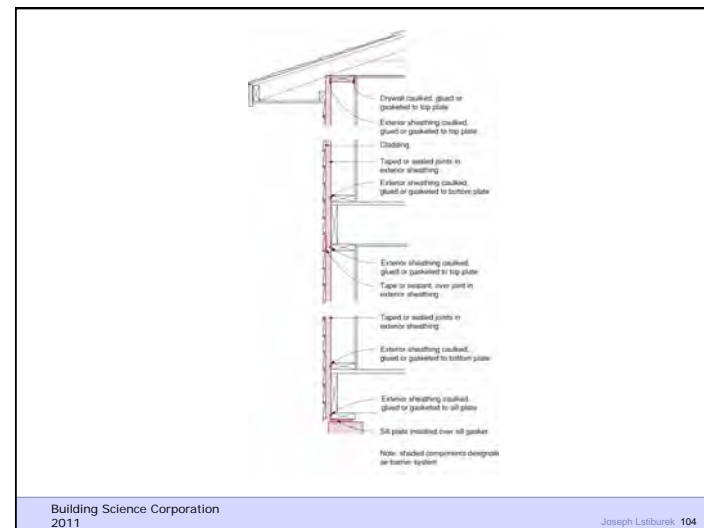
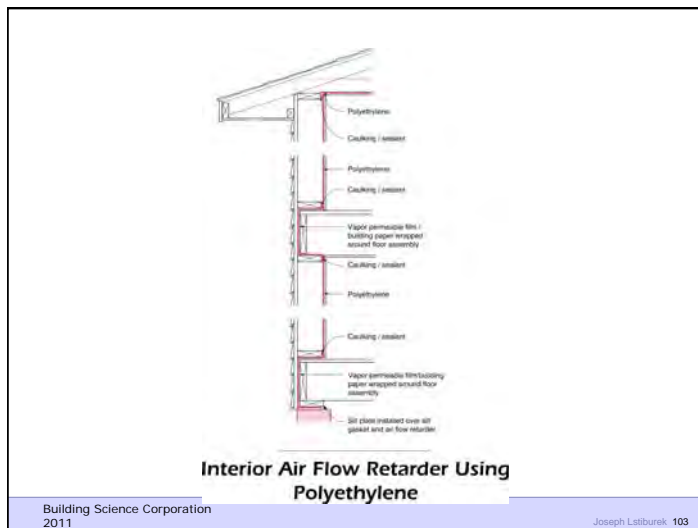
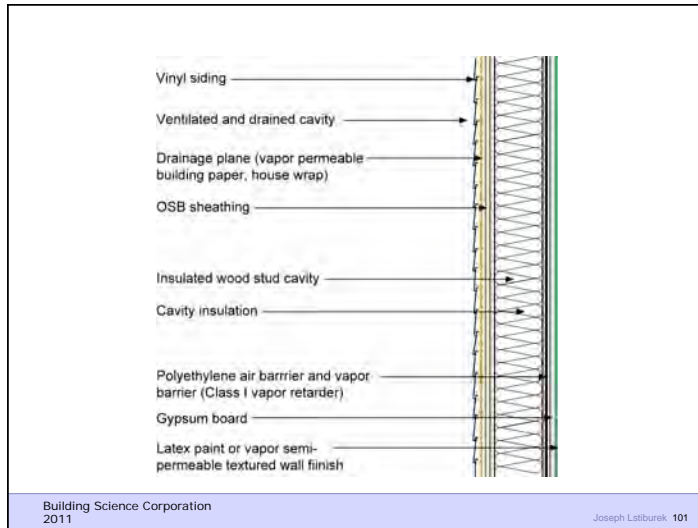



Building Science Corporation
2011

Joseph Lstiburek 105

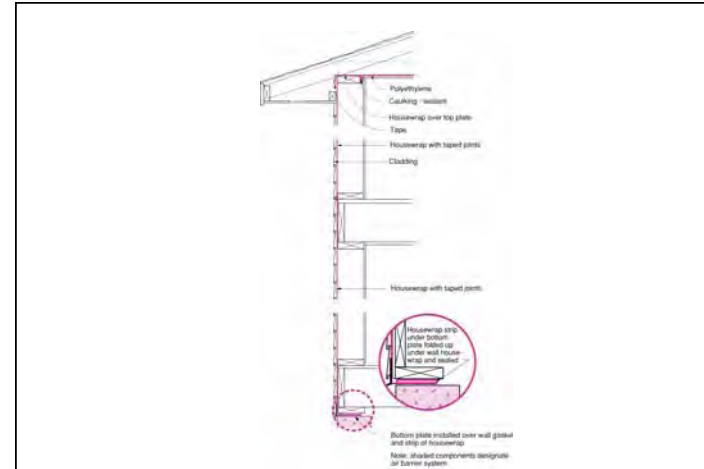

Building Science Corporation
2011

Joseph Lstiburek 106



Building Science Corporation
2011

Joseph Lstiburek 107

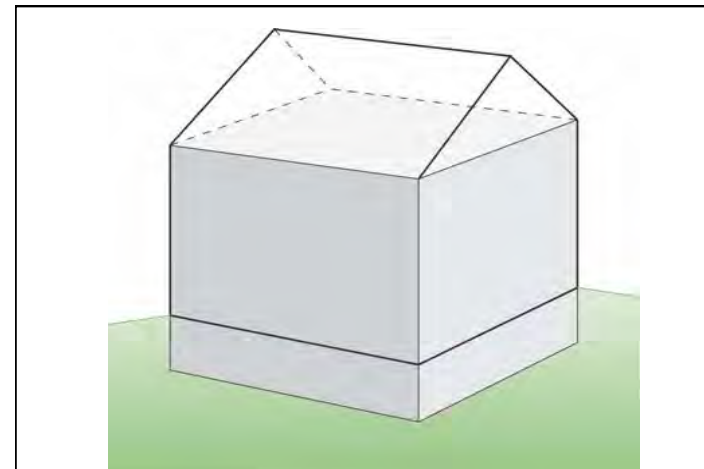

Building Science Corporation
2011

Joseph Lstiburek 108

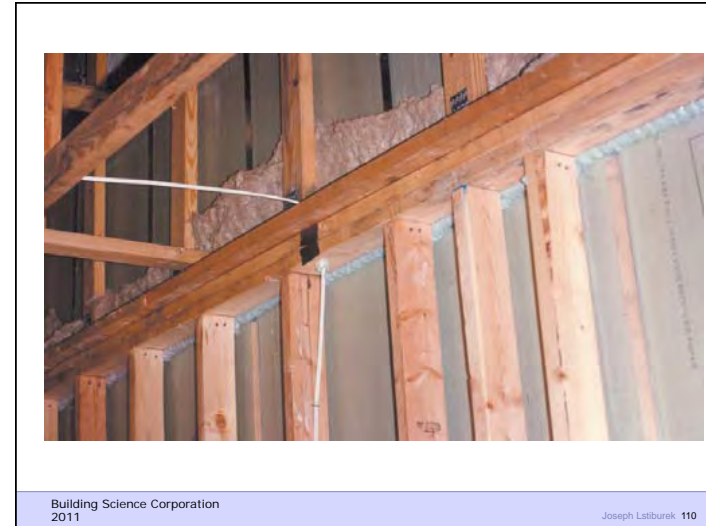
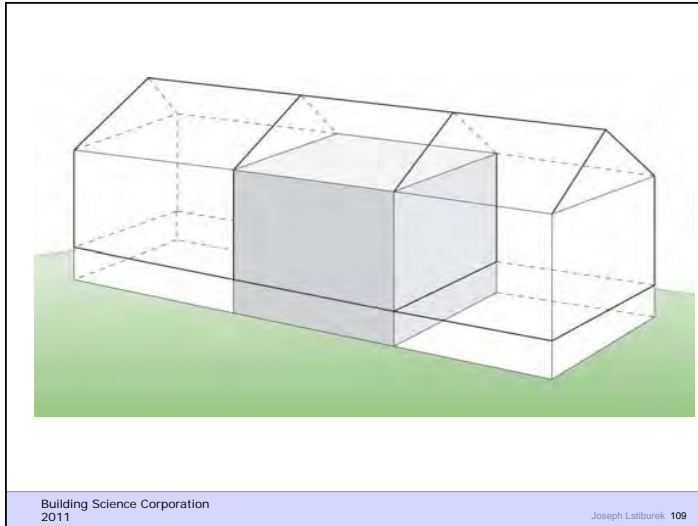

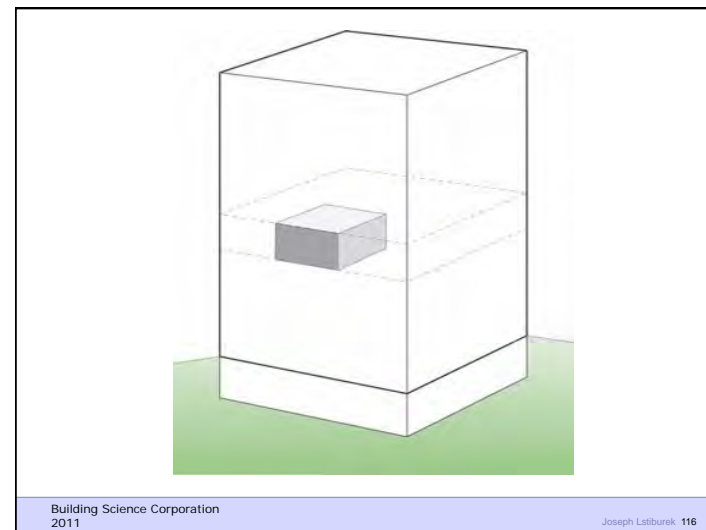
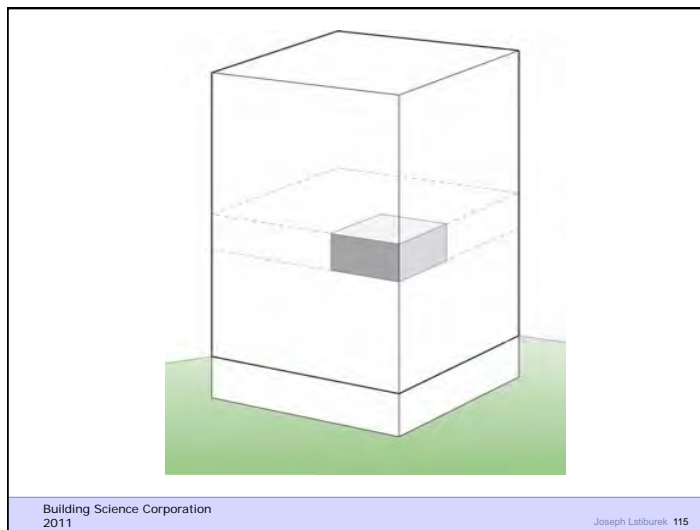
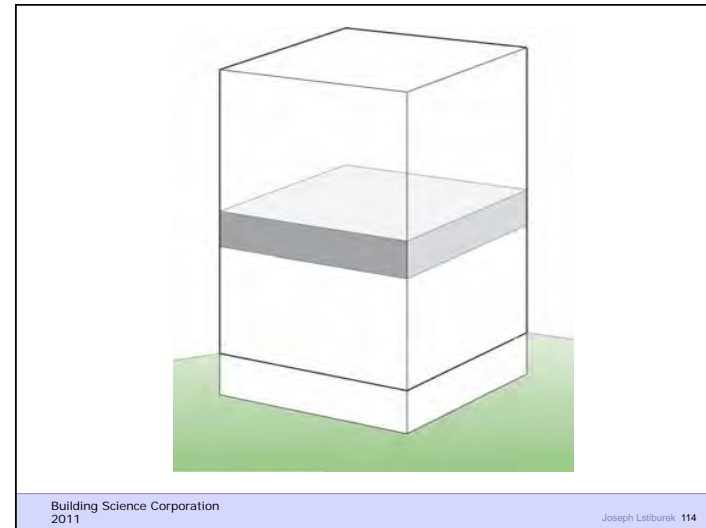
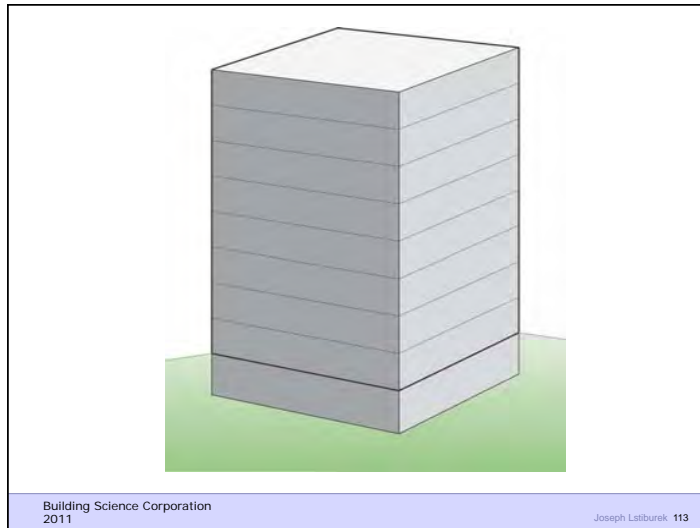

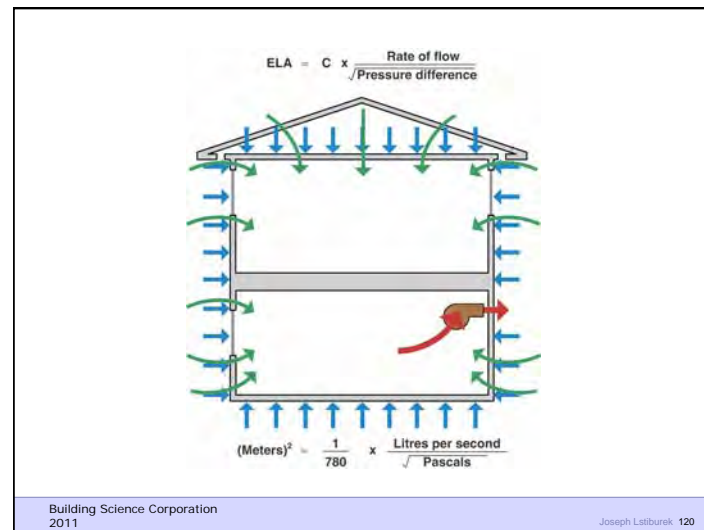
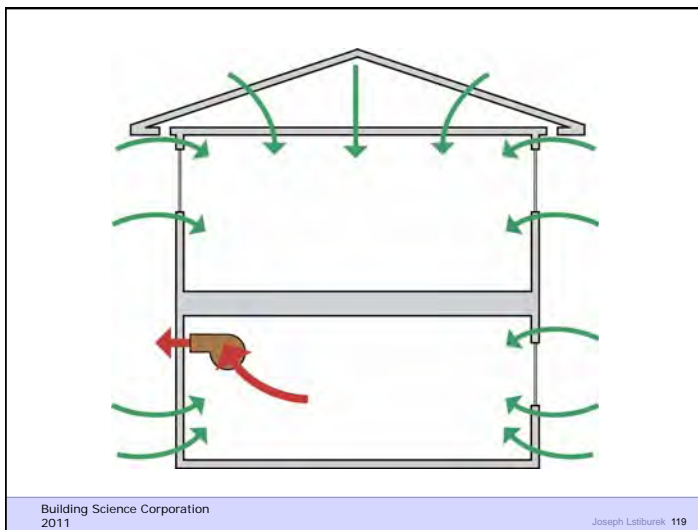
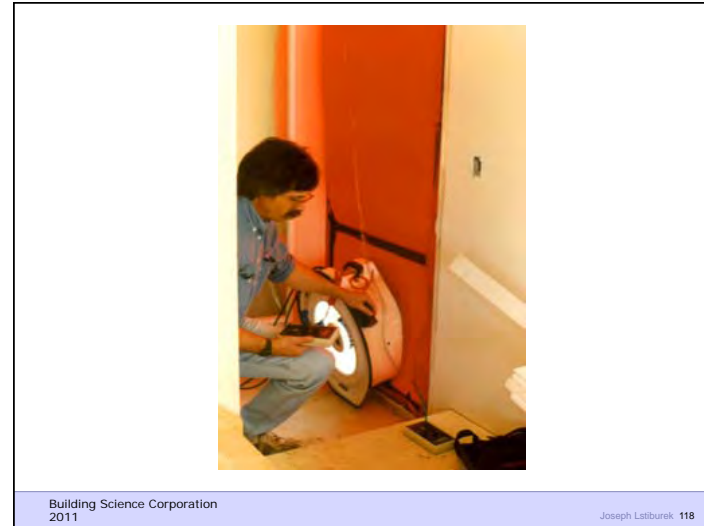

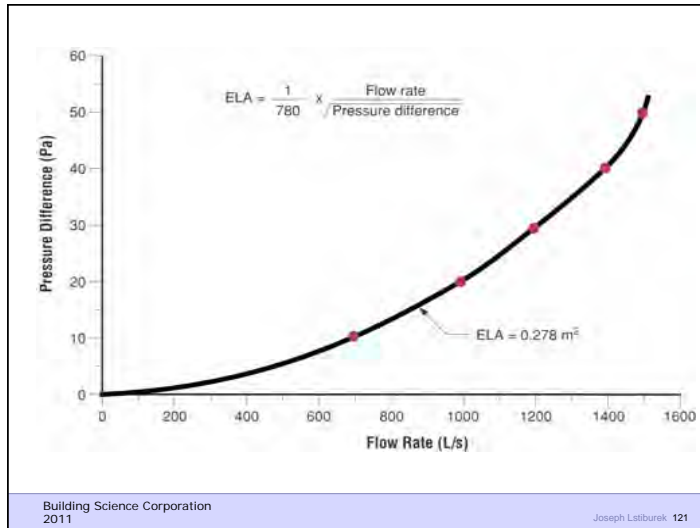

Stuff That Is Not Particularly Useful But Studied and Researched to Death

Stuff That Is Very Useful but Ignored by the Research Community

Building Science Corporation 2011 Joseph Lstiburek 122

Stuff That Is Not Particularly Useful But Studied and Researched to Death

“this is called Physics”

Stuff That Is Very Useful but Ignored by the Research Community

“this is called Engineering”

Building Science Corporation 2011 Joseph Lstiburek 123

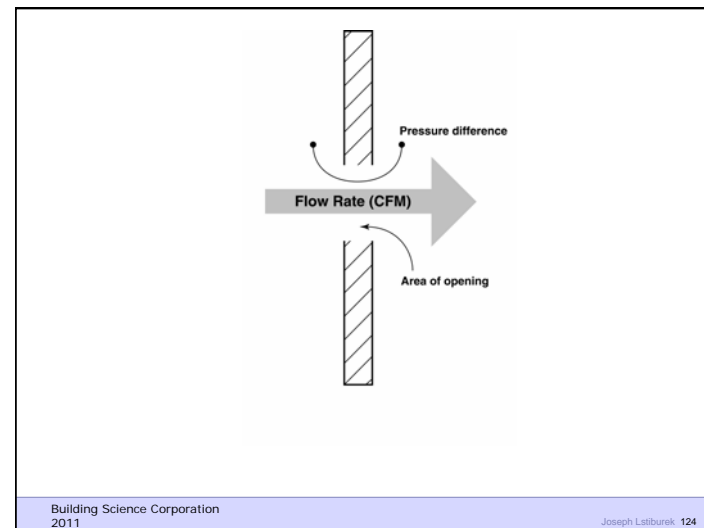

"this is a lie"

Building Science Corporation 2011 Joseph Lstiburek 125

Flow Through Orifices
Turbulent Flow - "inertial effects"

Flow Through Porous Media
Laminar Flow - "viscosity effects"

Building Science Corporation 2011 Joseph Lstiburek 126

Flow Through Orifices
Turbulent Flow - "inertial effects"

Flow Through Porous Media
Laminar Flow - "viscosity effects"

"true but not useful"

Building Science Corporation 2011 Joseph Lstiburek 127

$$Q = A C_D \sqrt{2} (P)^{\frac{1}{2}} \quad \text{Bernoulli}$$

$$Q = C_K (P) \quad \text{Darcy}$$

Building Science Corporation 2011 Joseph Lstiburek 128

$$Q = A \delta C_D^{-2} (P)^{\frac{1}{2}} \quad \text{Bernoulli}$$

$$Q = C_K (P) \quad \text{Darcy}$$

$$Q = A \delta C (P)^{\frac{1}{2}}$$

$$Q = C (P)$$

Building Science Corporation 2011 Joseph Lstiburek 129

$$Q = A \delta C_D^{-2} (P)^{\frac{1}{2}} \quad \text{Bernoulli}$$

$$Q = C_K (P) \quad \text{Darcy}$$

$$Q = A \delta C (P)^{\frac{1}{2}}$$

$$Q = C (P)$$

$$Q = A \delta C (P)^n \quad \text{Kronval "an engineer"}$$

Building Science Corporation 2011 Joseph Lstiburek 130

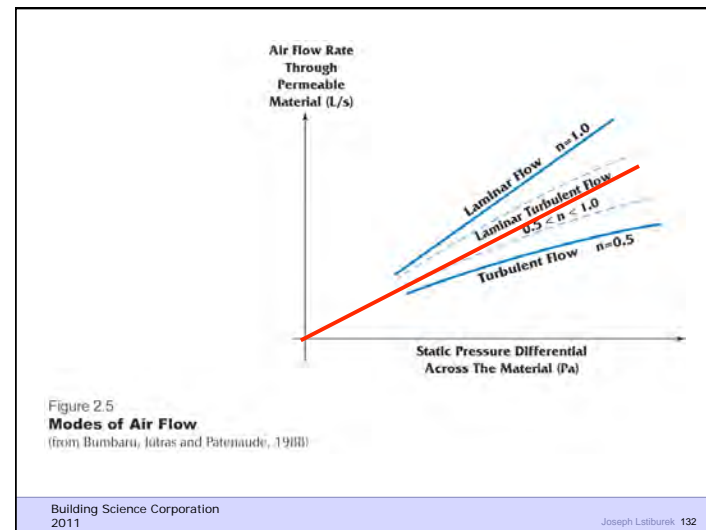
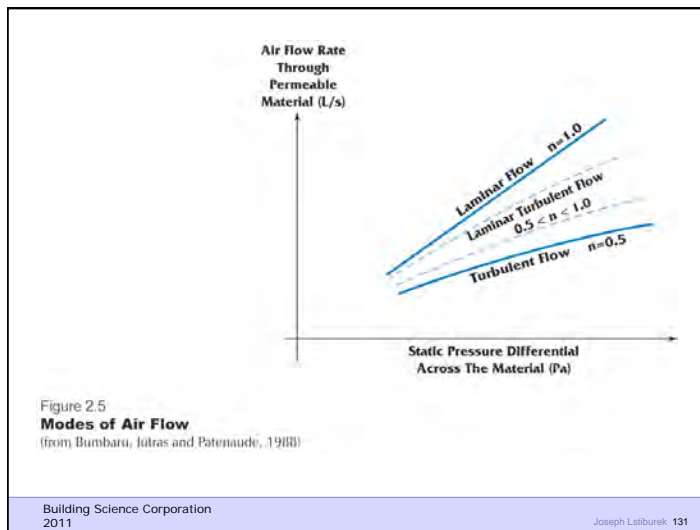

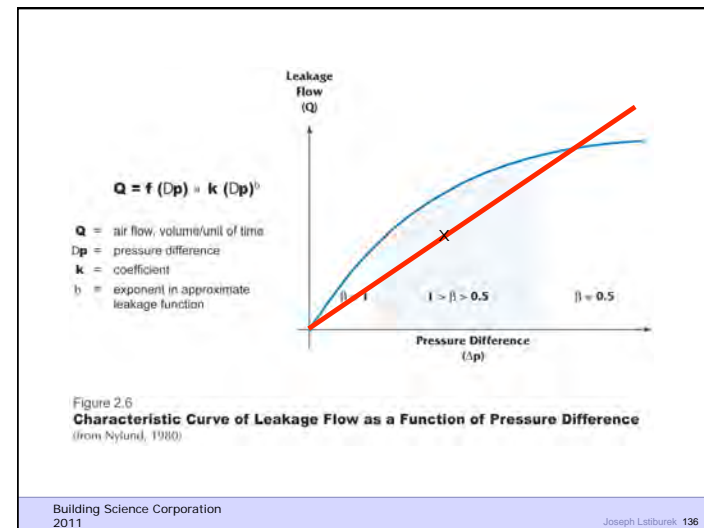
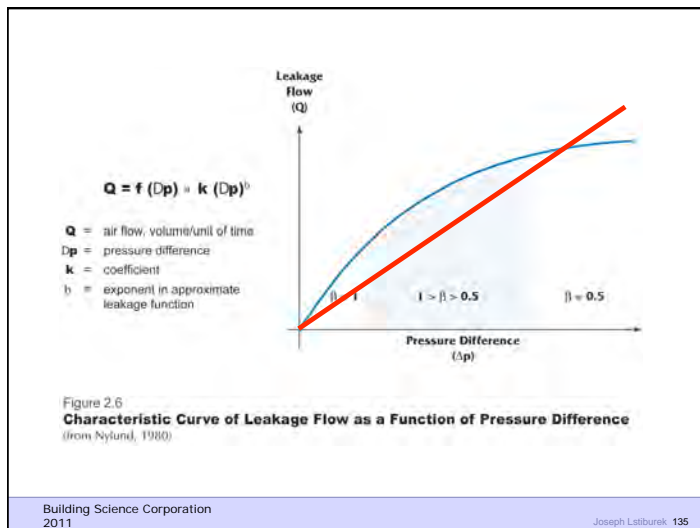
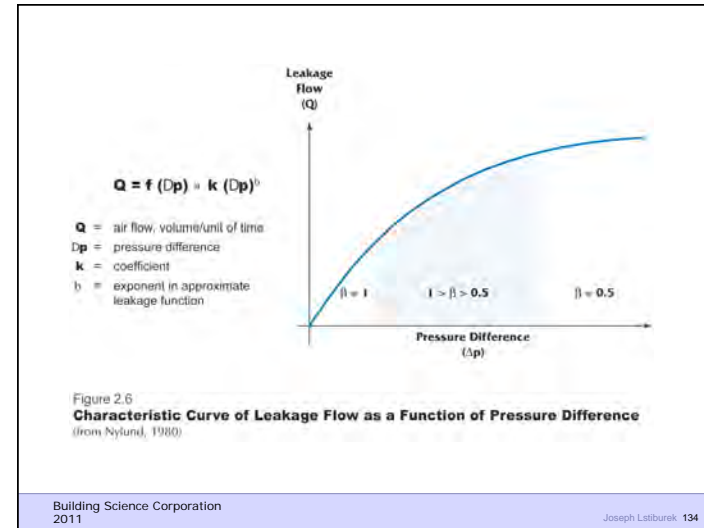
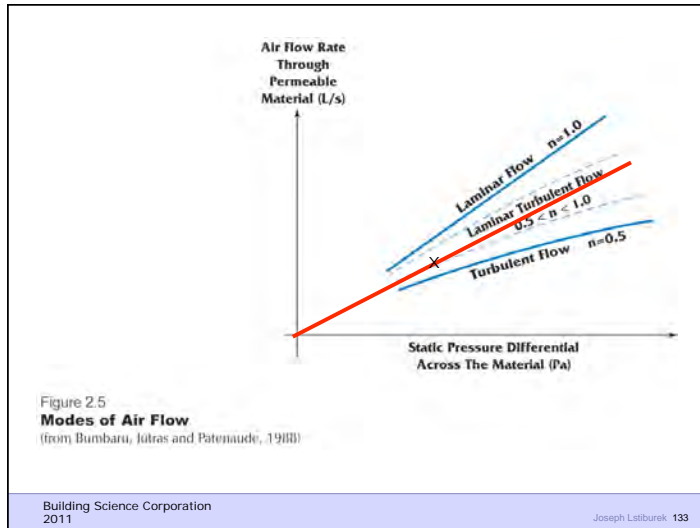

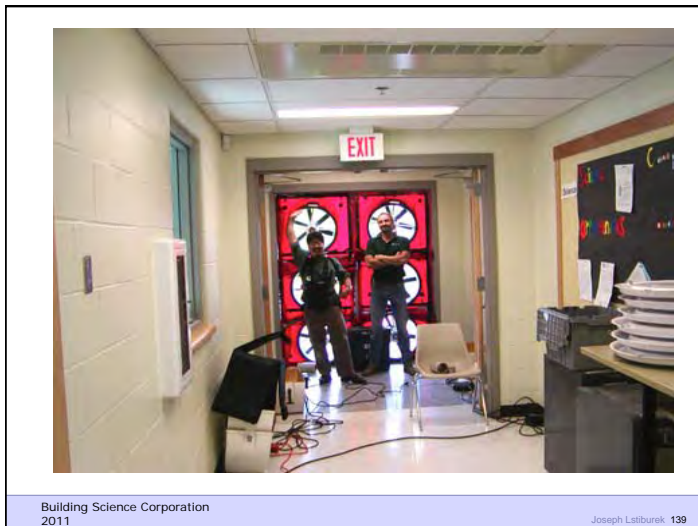
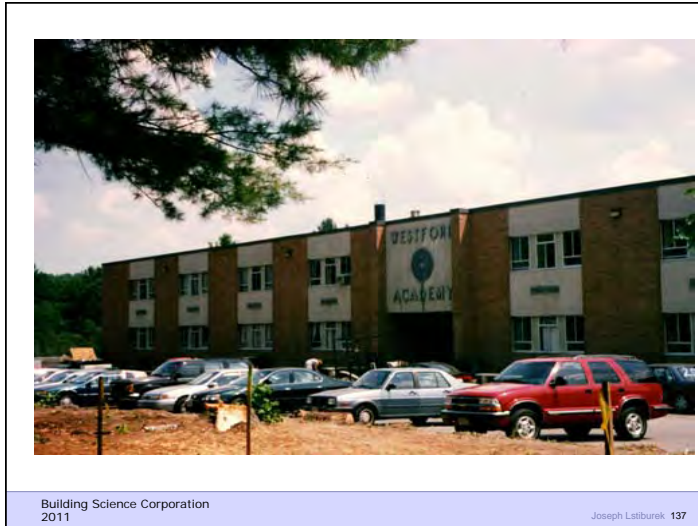

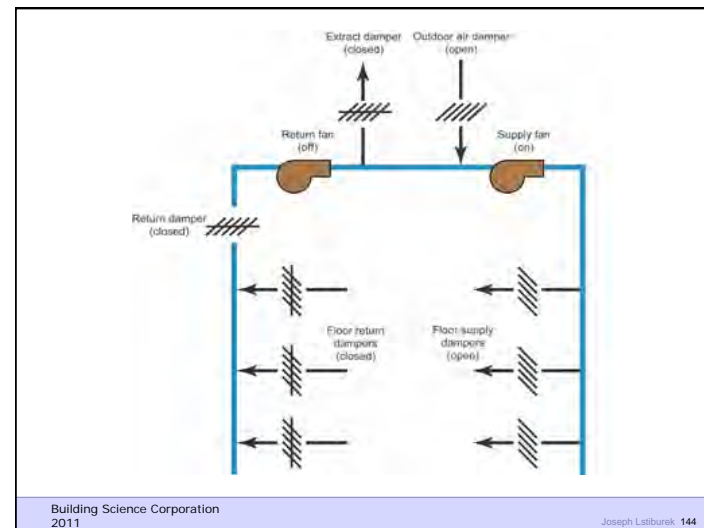
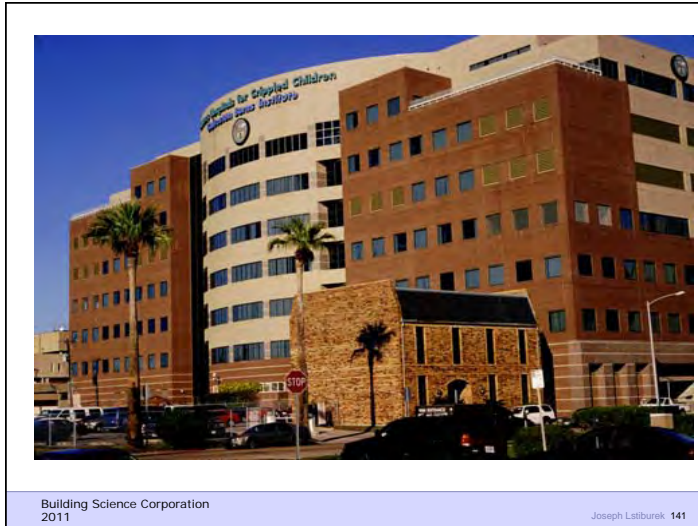

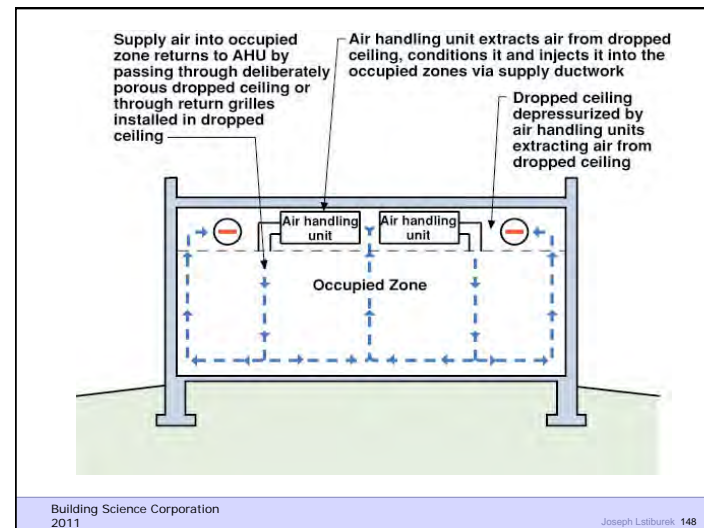
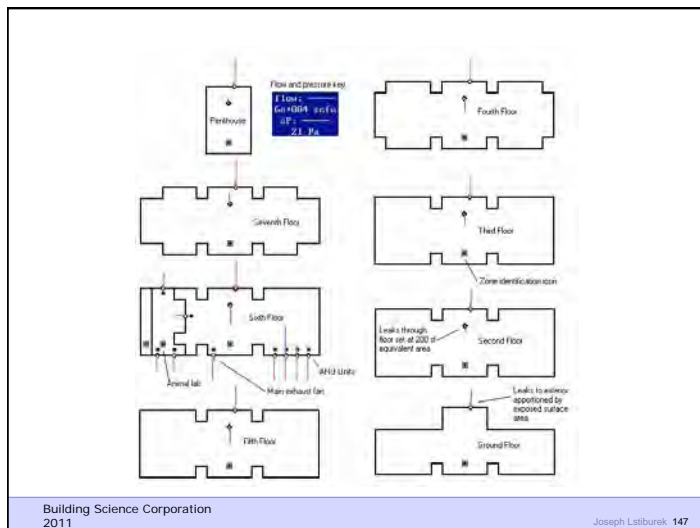
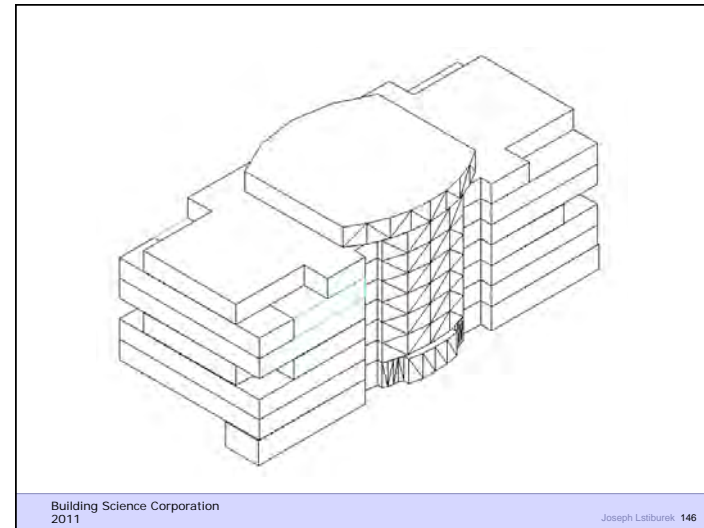
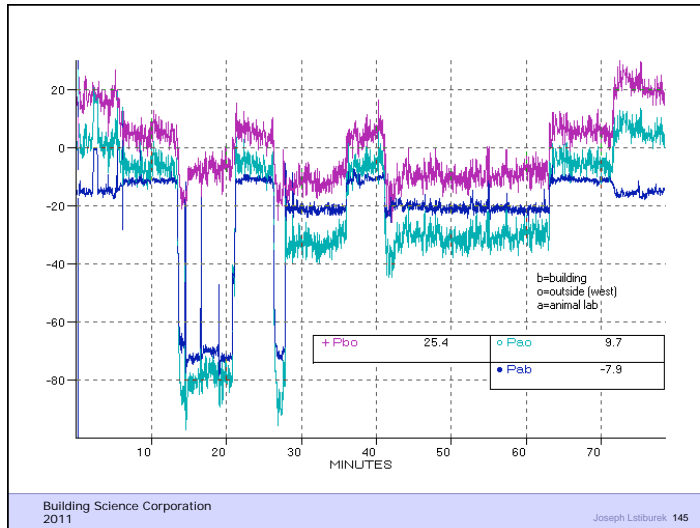

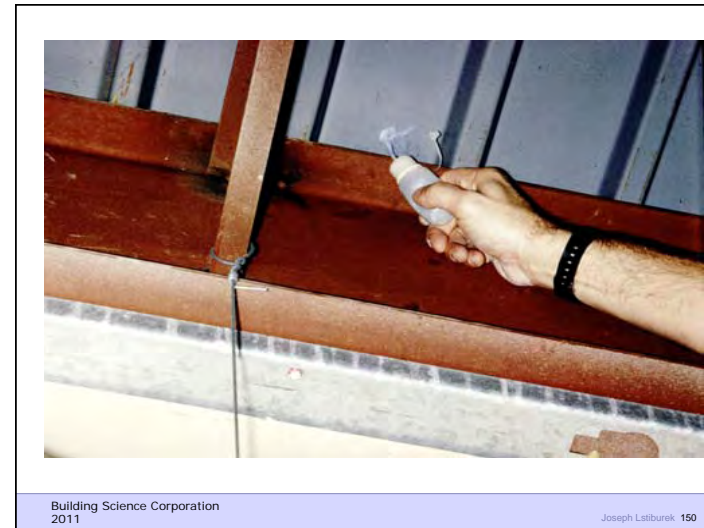
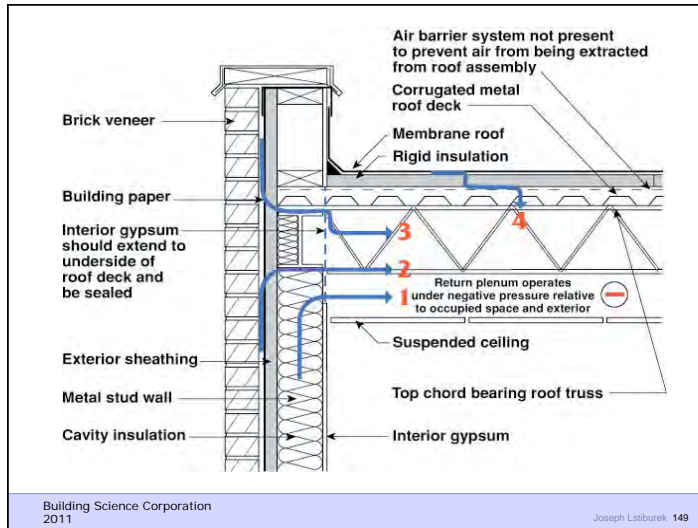

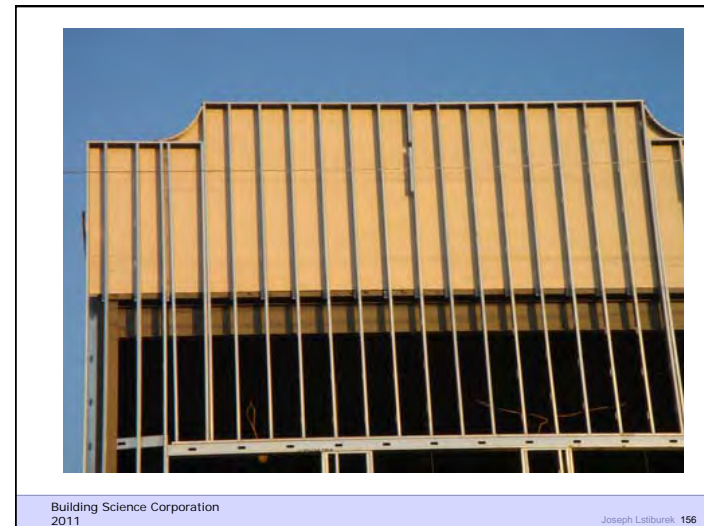
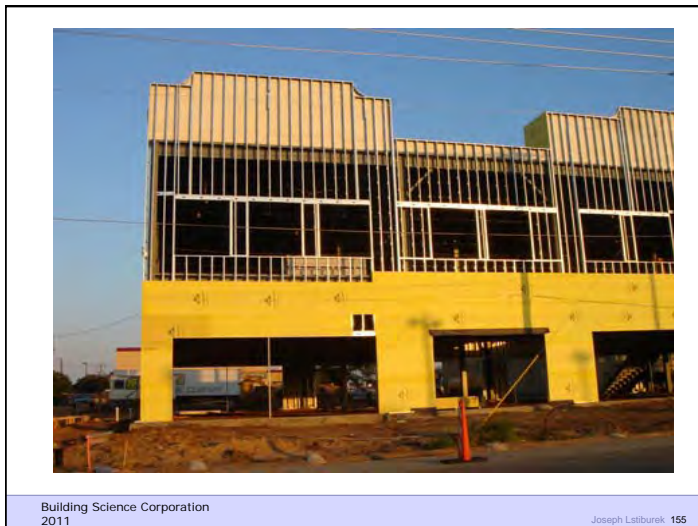
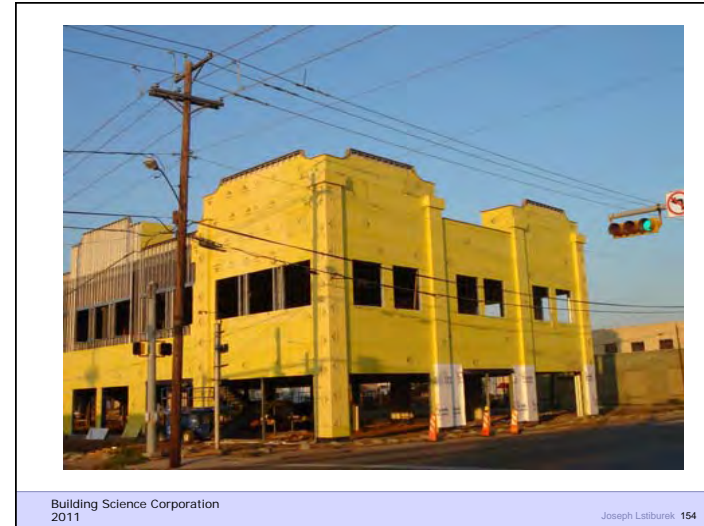

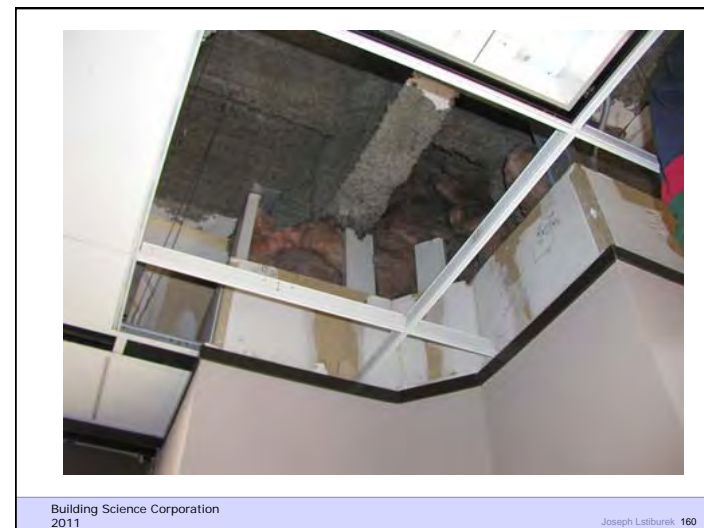
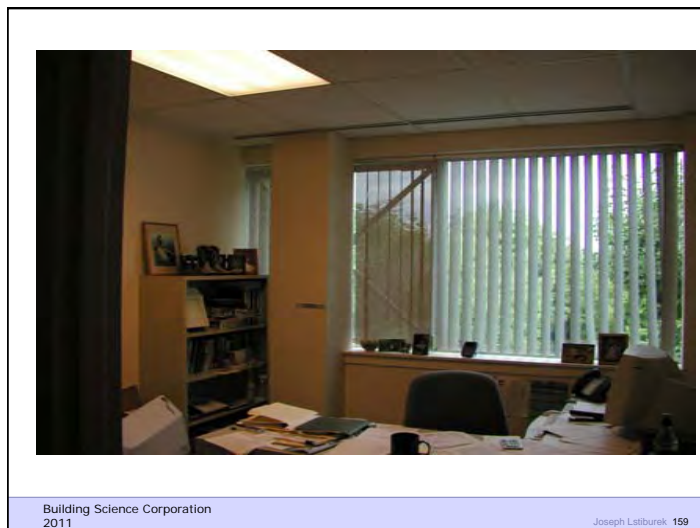
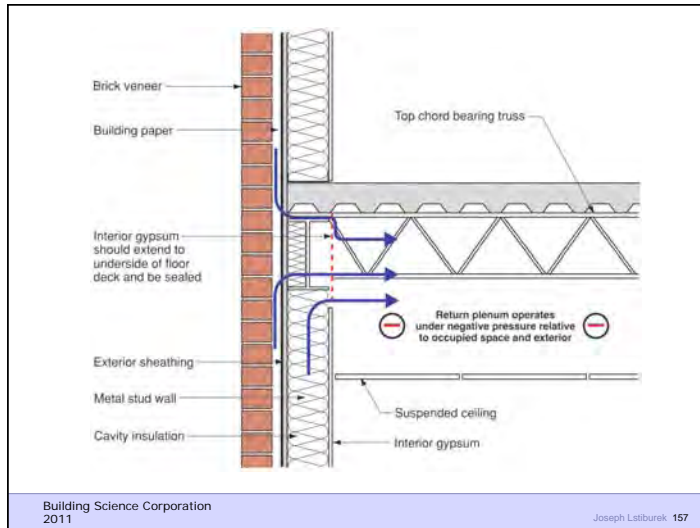

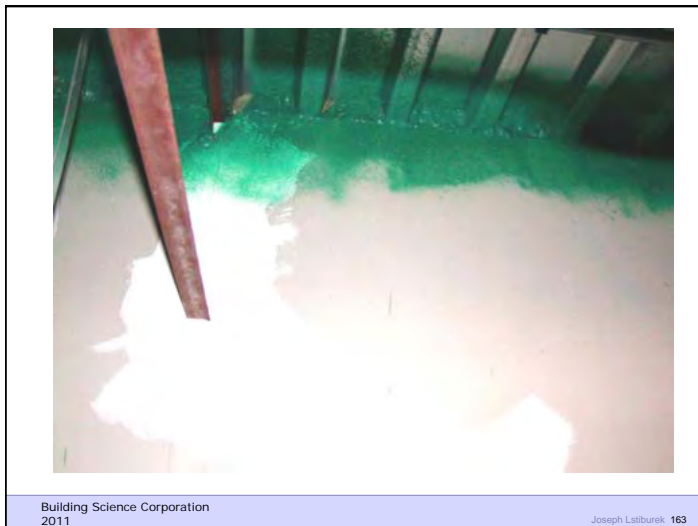
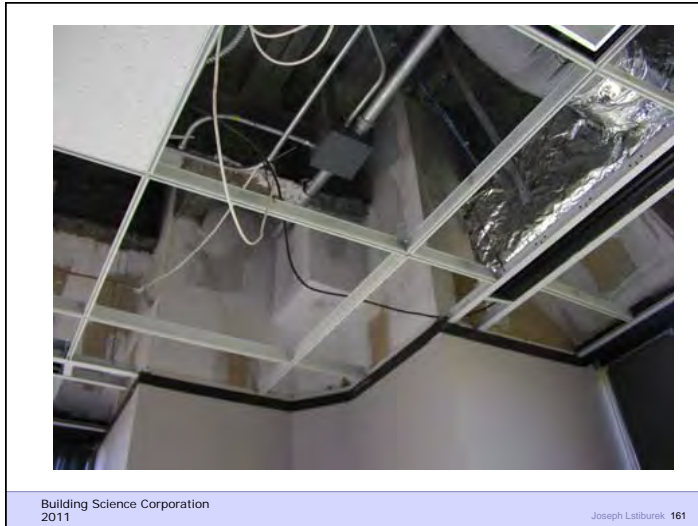

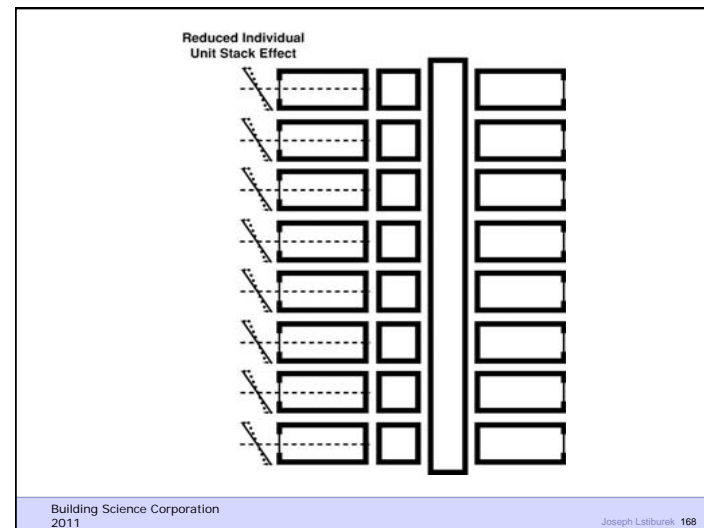
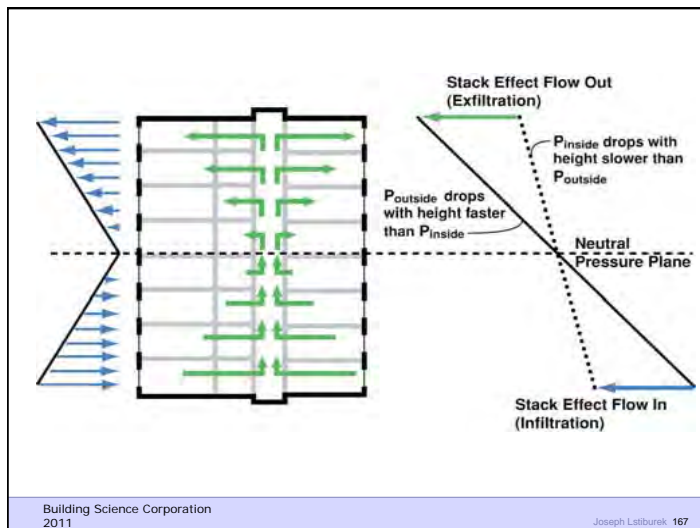
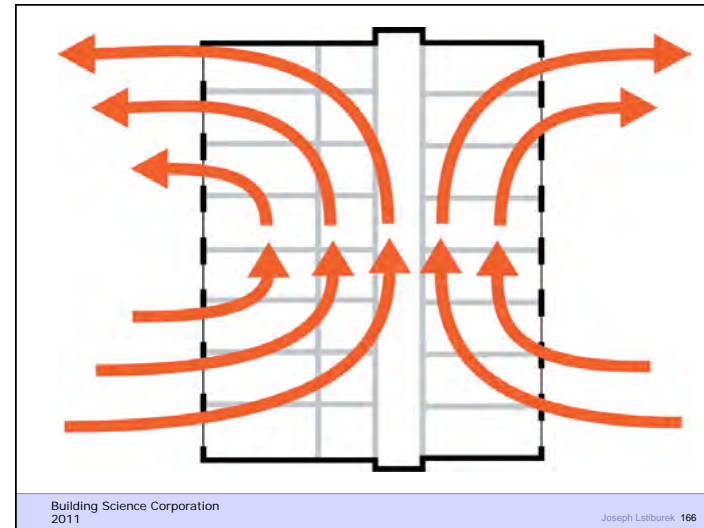
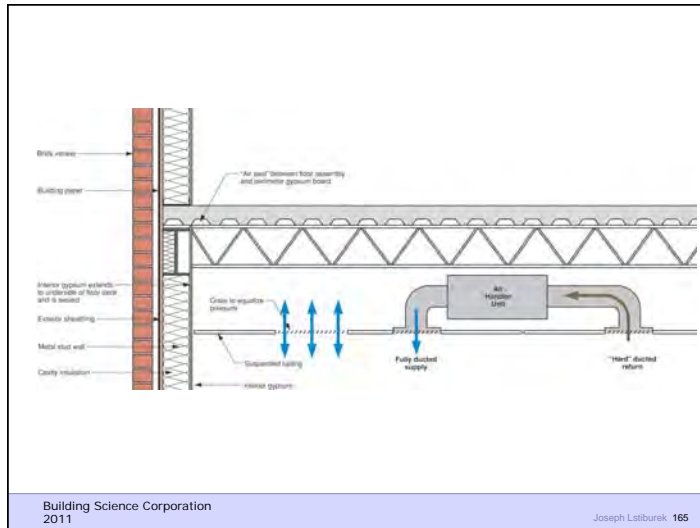

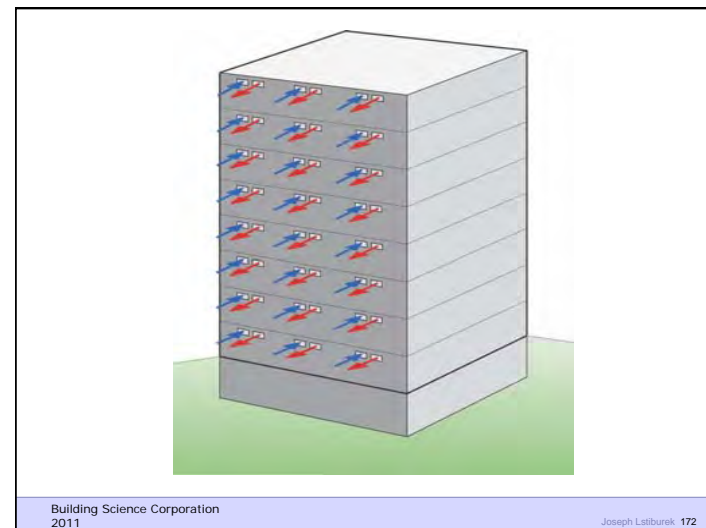
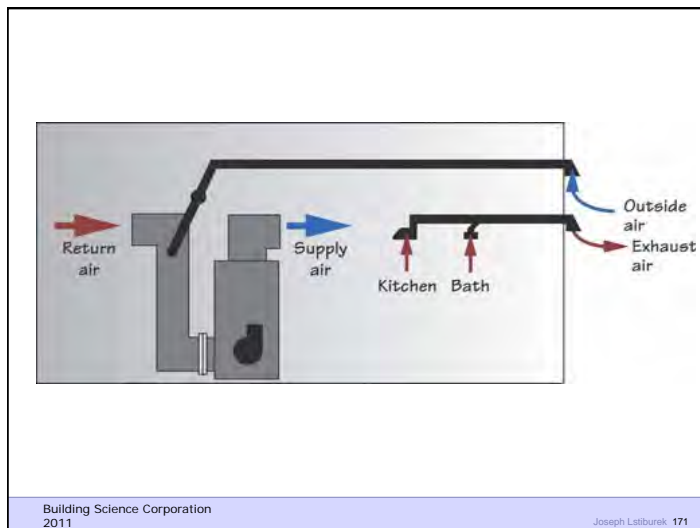
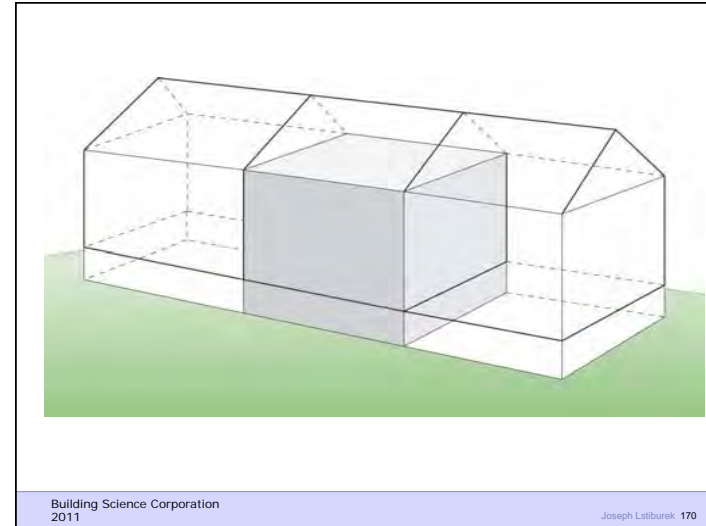
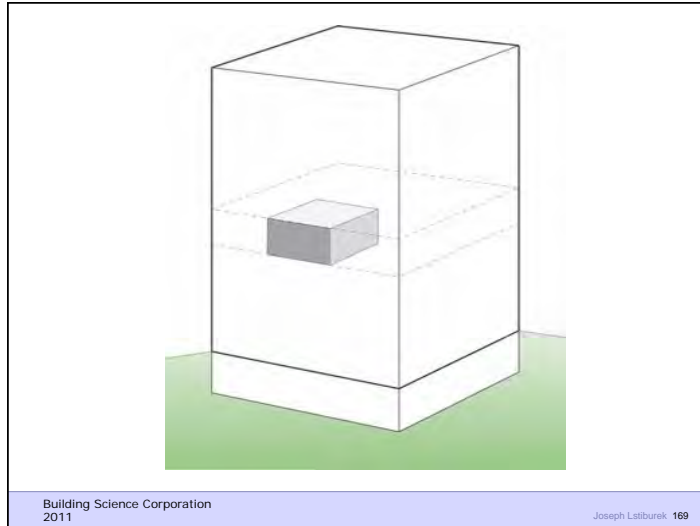

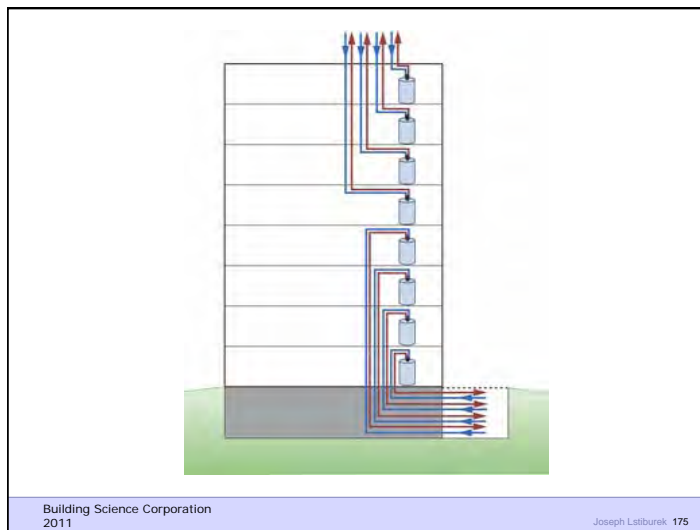
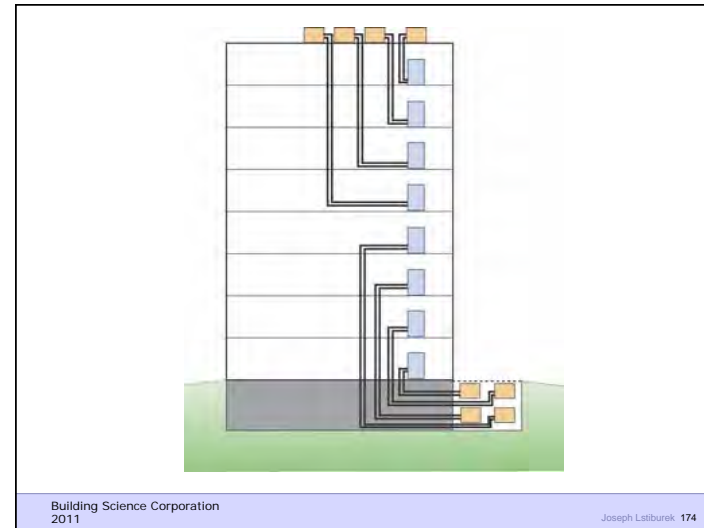
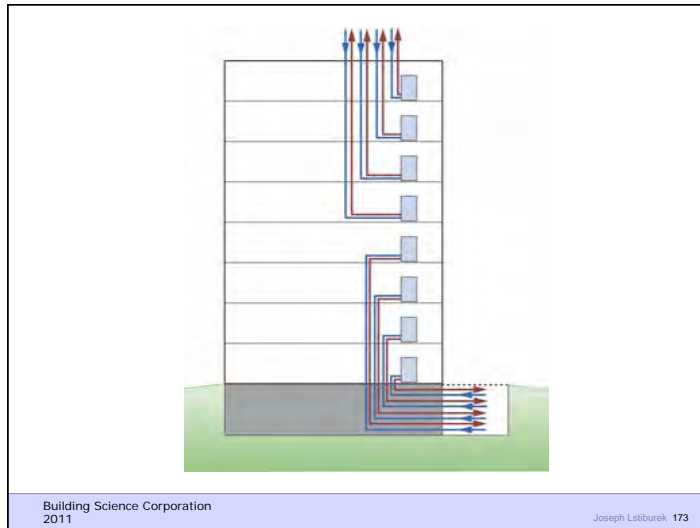

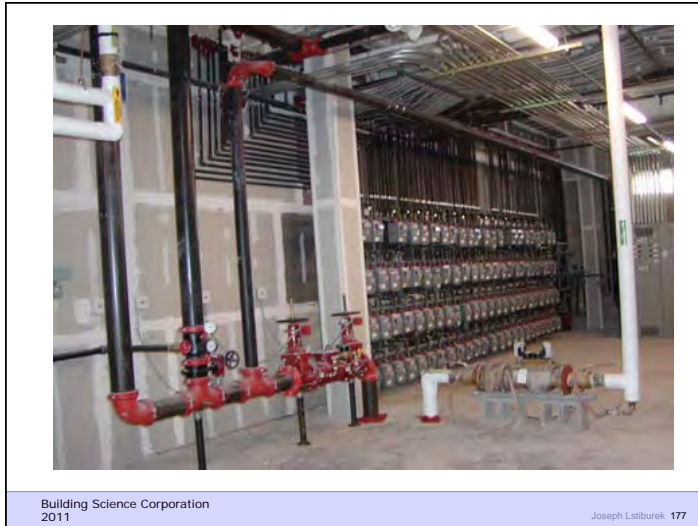

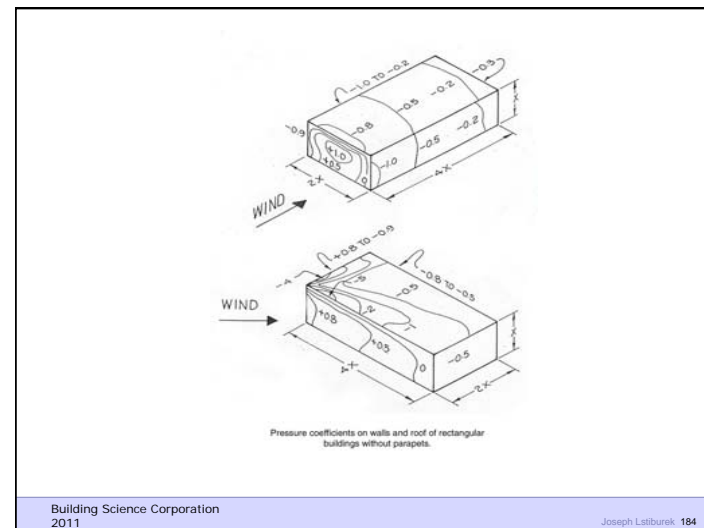
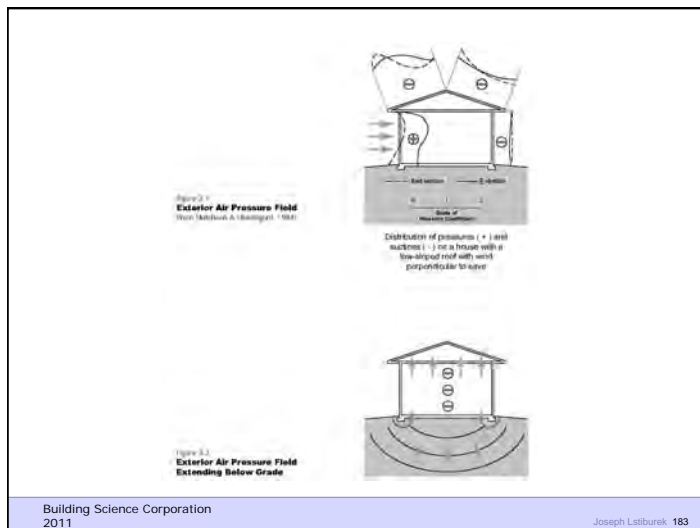
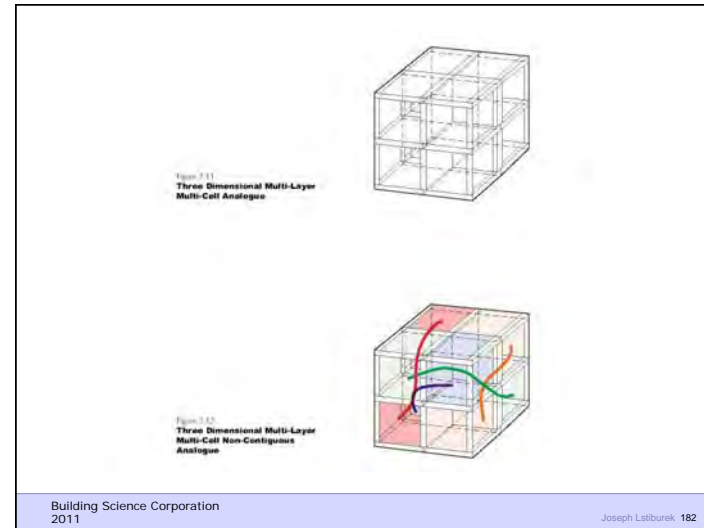
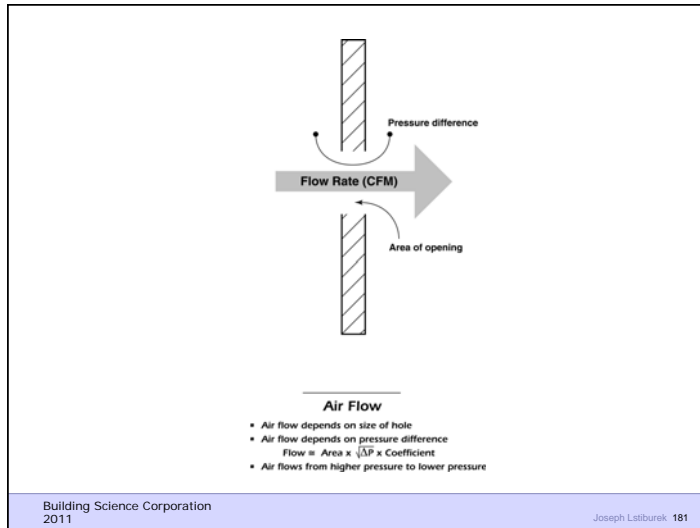

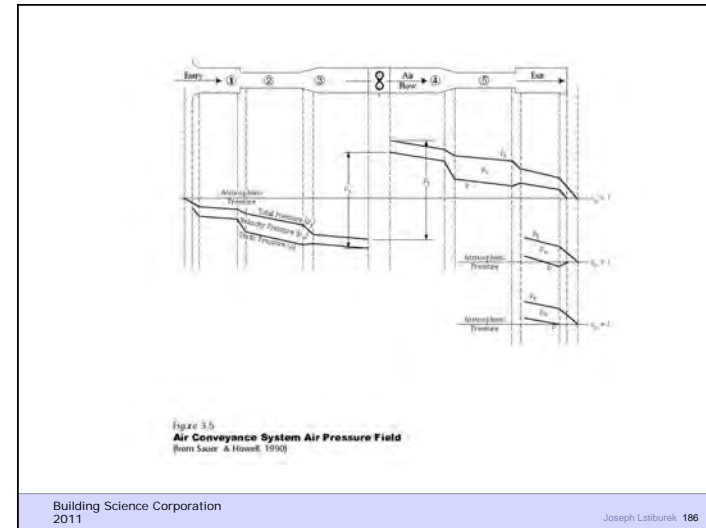
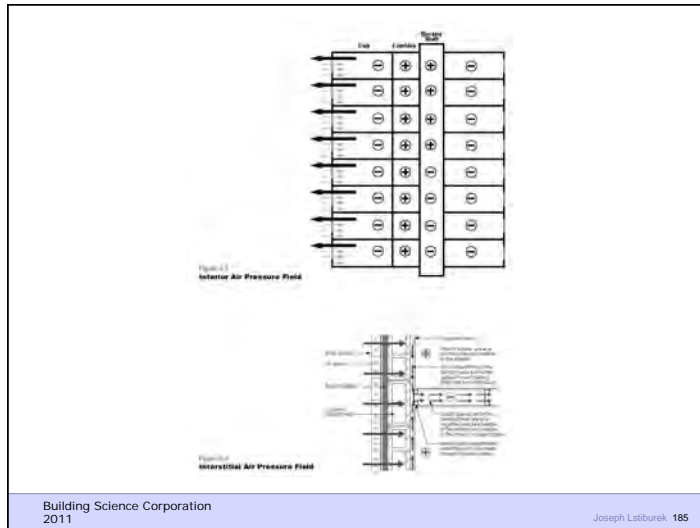

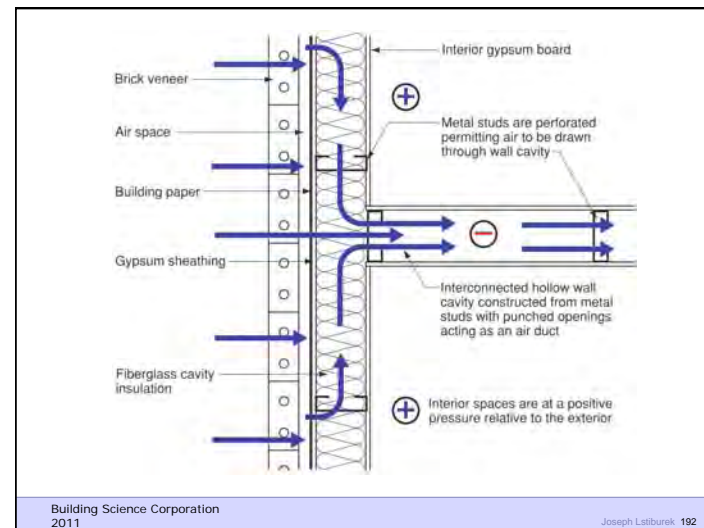
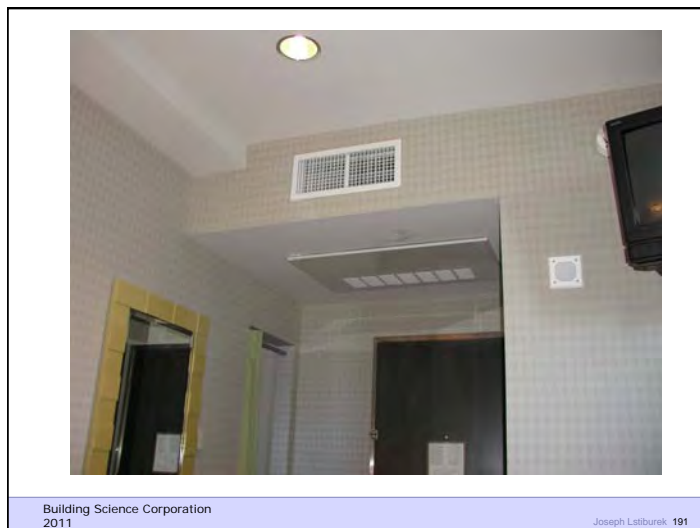
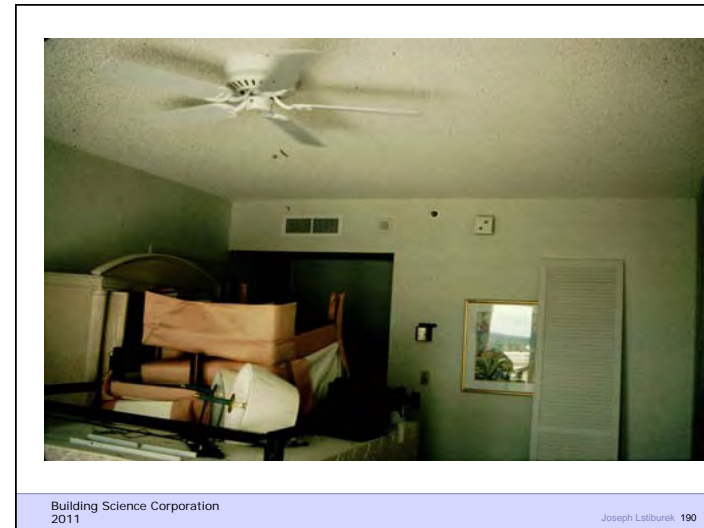
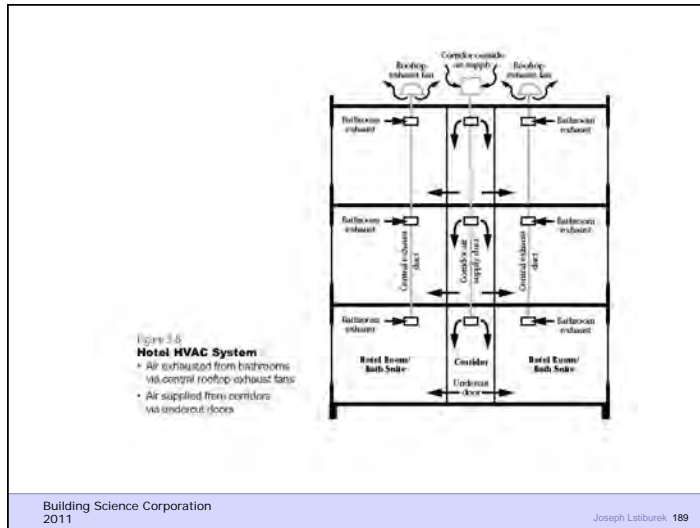

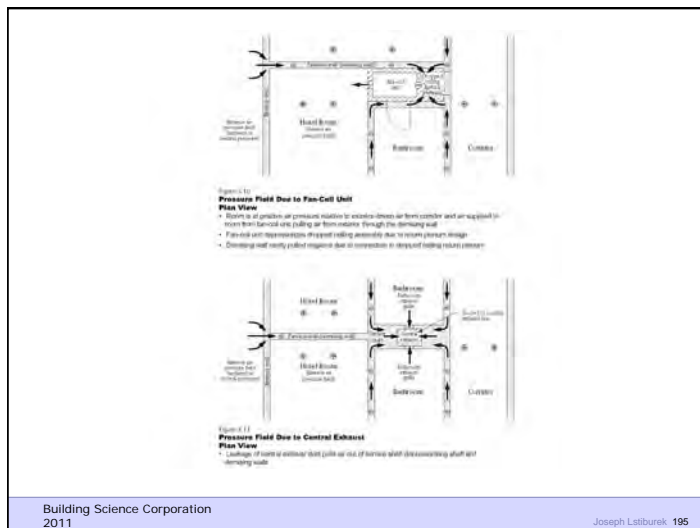
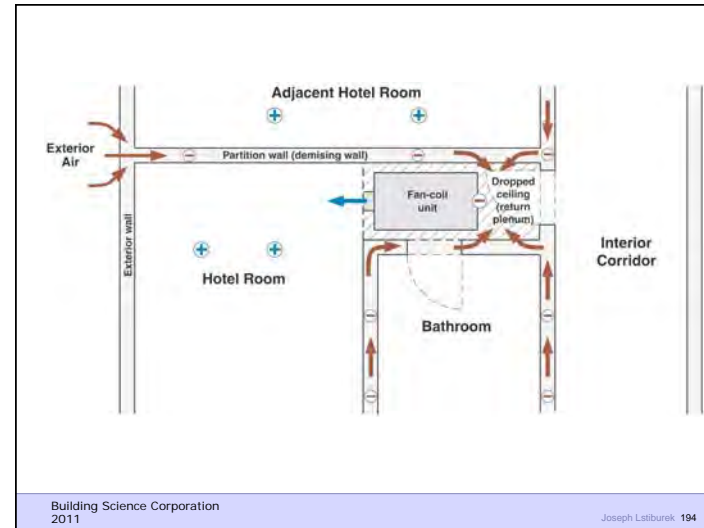
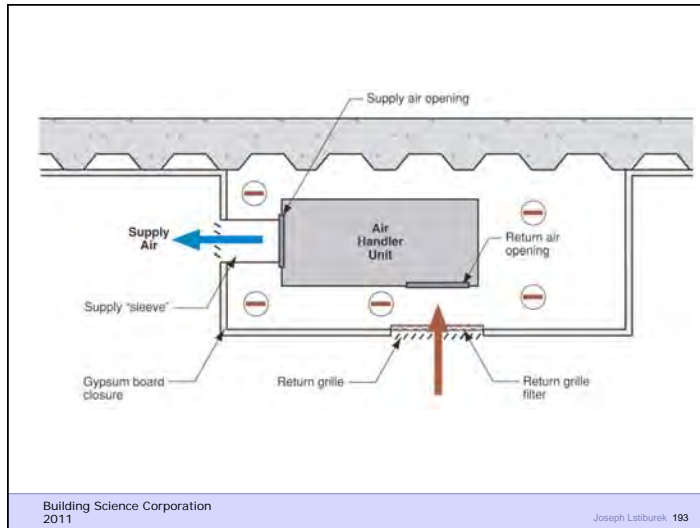

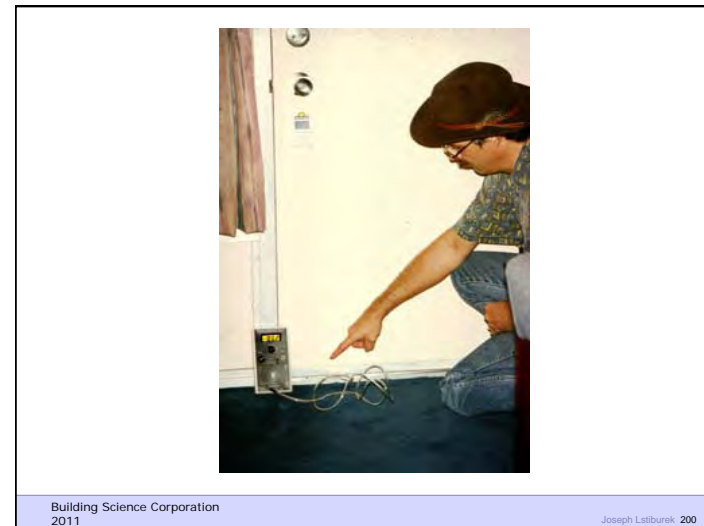
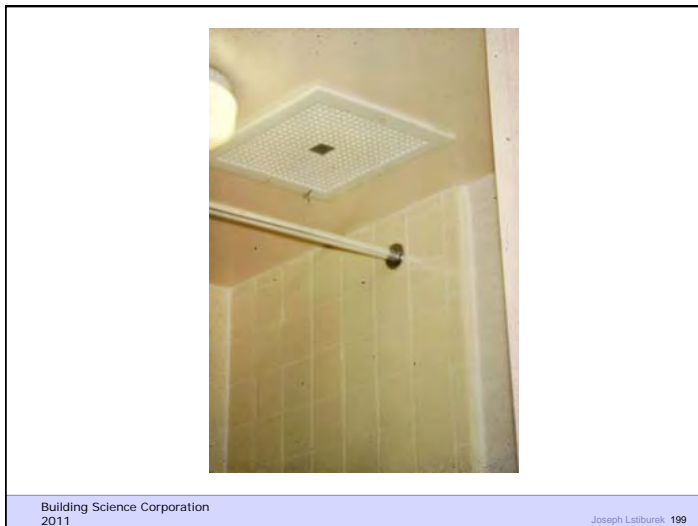

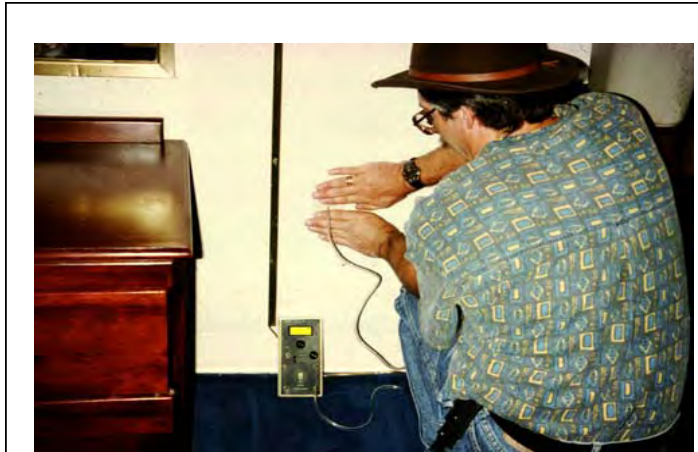

Building Science Corporation
2011

Joseph Lstiburek 201



Building Science Corporation
2011

Joseph Lstiburek 202

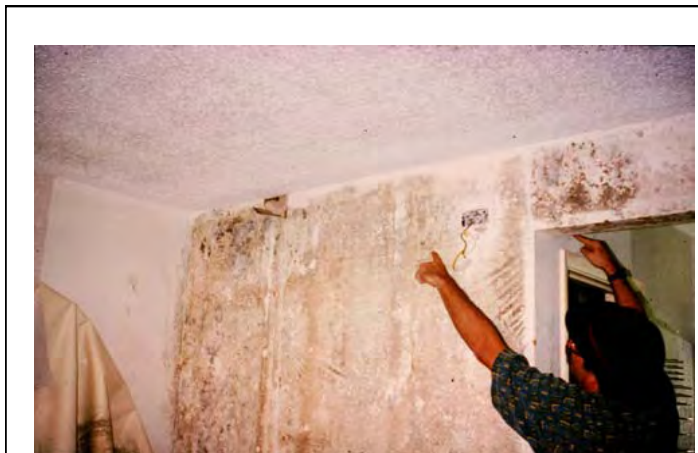

Building Science Corporation
2011

Joseph Lstiburek 203



Building Science Corporation
2011

Joseph Lstiburek 204



Building Science Corporation
2011

Joseph Lstiburek 205