

External Insulation of Masonry Walls and Wood Framed Walls

Building America Report - 1204

1 August 2012 (rev. 1/2013)

Peter Baker

Abstract:

The use of exterior insulation is an effective means to increase the overall thermal resistance of wall assemblies that also has other advantages of improved water management and often increased air tightness of the building. However, the engineering basis and support for this work has not been conducted, resulting in obstacles for building official and building code acceptance. Additionally, the water management and integration of window systems, door systems, decks, balconies, and roof-wall intersections have not been adequately developed. This gap also stands in the way of wider deployment.

This research project developed baseline engineering analysis to support the installation of thick layers of exterior insulation (2" to 8") on existing masonry walls and wood framed walls through the use of wood furring strips (fastened through the insulation back to the structure) as a cladding attachment location. Furthermore, water management details necessary to connect the exterior insulated wall assemblies to roofs, balconies, decks, and windows were created to provide guidance on the integration of exterior insulation strategies with other enclosure elements.

External Insulation of Masonry Walls and Wood Framed Walls

P. Baker
Building Science Corporation

January 2013

External Insulation of Masonry Walls and Wood Framed Walls

P. Baker
Building Science Corporation

January 2013

NOTICE

This report was prepared as an account of work sponsored by an agency of the United States government. Neither the United States government nor any agency thereof, nor any of their employees, subcontractors, or affiliated partners makes any warranty, express or implied, or assumes any legal liability or responsibility for the accuracy, completeness, or usefulness of any information, apparatus, product, or process disclosed, or represents that its use would not infringe privately owned rights. Reference herein to any specific commercial product, process, or service by trade name, trademark, manufacturer, or otherwise does not necessarily constitute or imply its endorsement, recommendation, or favoring by the United States government or any agency thereof. The views and opinions of authors expressed herein do not necessarily state or reflect those of the United States government or any agency thereof.

Available electronically at <http://www.osti.gov/bridge>

Available for a processing fee to U.S. Department of Energy
and its contractors, in paper, from:

U.S. Department of Energy
Office of Scientific and Technical Information
P.O. Box 62
Oak Ridge, TN 37831-0062
phone: 865.576.8401
fax: 865.576.5728

email: <mailto:reports@adonis.osti.gov>

Available for sale to the public, in paper, from:

U.S. Department of Commerce
National Technical Information Service
5285 Port Royal Road
Springfield, VA 22161
phone: 800.553.6847
fax: 703.605.6900

email: orders@ntis.fedworld.gov

online ordering: <http://www.ntis.gov/ordering.htm>



External Insulation of Masonry Walls and Wood Framed Walls

Prepared for:

The National Renewable Energy Laboratory

On behalf of the U.S. Department of Energy's Building America Program

Office of Energy Efficiency and Renewable Energy

15013 Denver West Parkway

Golden, CO 80401

NREL Contract No. DE-AC36-08GO28308

Prepared by:

P. Baker

Building Science Corporation

30 Forest Street

Somerville, MA 02143

NREL Technical Monitor: Cheryn Metzger

Prepared under Subcontract No. KNDJ-0-40337-00

January 2013

[This page left blank]

Contents

List of Figures	vi
List of Tables	vii
Definitions	viii
Executive Summary	ix
1 Problem Statement	1
1.1 Introduction	1
1.2 Background	1
1.3 Cost Effectiveness	2
1.4 Other Benefits	4
2 Cladding Attachment Design	5
2.1 Previous Research	6
2.2 Wind Load Resistance	8
2.3 Gravity Load Resistance	10
3 Water Management Details	24
3.1 Exterior Insulation Materials	26
3.2 Water Resistive Barrier	27
3.3 Air Barrier	28
3.4 Cladding Attachment	28
3.5 Window Integration	29
3.6 Roof Integration	31
3.7 Balcony Integration	37
3.8 Deck Integration	37
4 Conclusions	38
References	40
Appendix A: Water Management Details	41
Appendix B: BEopt Simulation Graphs	107
B.1 Dallas, Texas	107
B.2 Kansas City, Missouri	108
B.3 Boston, Massachusetts	109
B.4 Duluth, Minnesota	110
Appendix C: Short-Term Deflection Test Protocol	111
C.1 Support Structure	111
C.2 Insulation and Furring Strips	111
C.3 Measuring Devices	111
C.4 Loading Mechanism	111
C.5 Testing Procedure	111
Appendix D: Long-Term Deflection Test Protocol	113
D.1 Support Structure	113
D.2 Insulation and Furring Strips	113
D.3 Measuring Devices	113
D.4 Loading Mechanism	113
D.5 Testing Procedure	113

List of Figures

Figure 1. Recommended cladding attachment design	5
Figure 2. Table 8 excerpt from Crandell (2010)	7
Figure 3. Example of fastener yielding in Mode IV	12
Figure 4. Short-term deflection test panel.....	14
Figure 5. Example hysteresis test plot for short-term deflection testing	15
Figure 6. Long-term deflection test panel	16
Figure 7. Dead weights attached to bottom edge of furring strips	17
Figure 8. Short-term deflection testing results (4-in.-thick insulation)	18
Figure 9. Short-term deflection testing results (8-in.-thick insulation)	18
Figure 10. Forces providing vertical displacement resistance	19
Figure 11. Deflection of furring strips under sustained load	21
Figure 12. Typical exterior retrofit detail, showing furring strip cladding attachment.....	25
Figure 13. Layering patterns of exterior insulation	26
Figure 14. WRB options with exterior insulation.....	27
Figure 15. Recommended air barrier location for retrofit assemblies	28
Figure 16. Recommended cladding attachment design	29
Figure 17. Detail of masonry sill removal to allow for insulation to return to the window frame.....	31
Figure 18. Common roof to wall connections	31
Figure 19. Different drainage plane placement for exterior insulation retrofits	32
Figure 20. Roof to wall interface with WRB behind the insulation	34
Figure 21. Roof to wall interface with WRB at the face of the insulation.....	37
Figure 22. Annualized energy related costs versus average source energy savings for Dallas, Texas.....	107
Figure 23. Average source energy savings reduction versus insulation level for Dallas, Texas...	108
Figure 24. Annualized energy related costs versus average source energy savings for Kansas City, Missouri	108
Figure 25. Average source energy savings reduction versus insulation level for Kansas City, Missouri	108
Figure 26. Annualized energy related costs versus average source energy savings for Boston, Massachusetts	109
Figure 27. Average source energy savings reduction versus insulation level for Boston, Massachusetts	109
Figure 28. Annualized energy related costs versus average source energy savings for Duluth, Minnesota	110
Figure 29. Average source energy savings reduction versus insulation level for Duluth, Minnesota	110

Unless otherwise noted, all figures were created by BSC.

List of Tables

Table 1. Benchmark House Characteristics	3
Table 2. Parametric Steps and Cost.....	3
Table 3. Reference Cities.....	4
Table 4. Insulation Materials	8
Table 5. Design Withdrawal Values for Various Common Screw Fasteners	9
Table 6. Adjustment Factors	9
Table 7. Allowable Design Wind Pressure (psf).....	10
Table 8. Yield Modes from AF&PA TR-12	11
Table 9. Nominal 5% Offset Limit (lb) at Connection Yield Mode for #8 Wood Screws.....	12
Table 10. Nominal 5% Offset Limit (lb) at Connection Yield Mode for #10 Wood Screws.....	13
Table 11. Nominal 5% Offset Limit (lb) at Connection Yield Mode for #12 Wood Screws.....	13
Table 12. Nominal 5% Offset Limit (lb) at Connection Yield Mode for ¼-in. Lag Screws.....	13
Table 13. Target Loads for Short-Term Deflection Testing	15

Unless otherwise noted, all tables were created by BSC.

Definitions

AF&PA	American Forest & Paper Association
BEopt	Building Energy Optimization (software). More information about BEopt can be found at http://beopt.nrel.gov/
BSC	Building Science Corporation. More information about BSC can be found at www.buildingscience.com
CMU	Concrete masonry unit
EPS	Expanded polystyrene
FSC	Foam Sheathing Coalition
ft ²	Square foot
in.	Inch
lb	Pound
NDS	National Design Specification for Wood Construction
NYSERDA	New York State Energy Research and Development Authority
OSB	Oriented strand board
PIC	Polyisocyanurate
psf	Pounds per square foot
RH	Relative humidity
s	Second
SFA	Steel Framing Alliance
SPF	Spruce-Pine-Fir
TR-12	General Dowel Equations for Calculating Lateral Connection Values: AF&PA Technical Report 12 (AF&PA 1999)
WRB	Water resistive barrier
XPS	Extruded polystyrene

Executive Summary

Exterior insulation is an effective means for increasing the overall thermal resistance of wall assemblies. It also has other advantages including improved water management and often increased airtightness of the building. The engineering basis and support work for exterior insulation, however, has not been conducted, resulting in obstacles for building official and building code acceptance. Additionally, water management strategies and integration practices for window systems, door systems, decks, balconies, and roof wall intersections have not been adequately developed. This gap also stands in the way of wider deployment.

In this research project, the Building Science Corporation (BSC) developed baseline engineering analysis to support the installation of thick layers of exterior insulation (2 in. to 8 in.) on existing masonry walls and wood framed walls. Wood furring strips (fastened through the insulation back to the structure) were used as a cladding attachment location. Water management details necessary to connect the exterior insulated wall assemblies to roofs, balconies, decks, and windows were created as guidance for integrating exterior insulation strategies with other enclosure elements.

Wind load withdrawal resistance capacities were determined based on guidance outlined in the *National Design Specification for Wood Construction* (American Forest & Paper Association 2005, Chapter 11, “Dowel Type Fasteners”). In all cases, the withdrawal capacity is independent of the thickness of the exterior insulation.

Analysis of gravity load capacity is more complex and has multiple variables that needed to be considered for the cladding attachment. BSC completed a numerical analysis for insulation thicknesses from 1 in. to 8 in. (in 1-in. increments). The laboratory testing was limited to 4-in.-thick installations and 8-in.-thick installations. The intent was that the results from the 4-in. test could be applied to installations up to 4 in. and the 8-in. test results could be applied to installations between 4 in. and 8 in.

BSC determined that acceptable deflection instead of ultimate capacity of the systems governed the design. For lap sidings and panel claddings with joints (metal, vinyl, wood, and fiber cement), movement is aesthetic in nature and not a health and safety issue. The acceptable amount of deflection will be a function of acceptable aesthetics for the cladding system chosen. For most lap siding or panel cladding systems, variations up to 1/16 in. or even 1/8 in. may be acceptable because the material and installation tolerances are easily greater than the potential gap development. BSC recommends, then, that the deflection be limited to 1/16 in. in service unless it is demonstrated that larger deflections can be tolerated.

For brittle claddings (such as stucco and cultured stone), movement could lead to cracking and potentially spalling of the material. For these systems BSC recommends that the in-service deflection limit be set to prevent deflection that may damage the cladding or impair its function. A limit of 1/64 in. is proposed for brittle claddings after initial deflection.

Most common residential cladding systems (metal, vinyl, wood, and fiber cement) are lightweight enough (<5 psf) that attachment to furring over any thickness of insulation does not create an issue. For these cladding systems, the predicted deflection based on a reasonable

horizontal spacing (16-in. to 24-in. on center) and vertical fastener spacing (up to 24-in. on center), is so slight (1/200 in.), and creep effects are so minimal, that the deflection does not approach the proposed 1/16-in. maximum in-service deflection limit.

For heavier cladding systems (>10 psf) initial deflection is within the proposed deflection limit. There is, however, inadequate information about potential thermal and moisture expansion and contraction movements, as well as creep effects of certain insulation materials in exposed environments, to predict long-term service deflection. Additional research into the long-term deflection movement of heavier claddings in exposed environments is needed.

Integrating exterior insulation into the water management strategy of the building takes careful detailing at interfaces with other enclosure elements.

For the most part, placing the water resistive barrier to the exterior of the insulation has been the easiest because the details are largely similar to standard construction practices. Concern is often raised about how to support elements that were once positioned in the structural frame wall, which are now “pushed” outward into the plane of the exterior insulation (e.g., windows and step flashings). Careful use of blocking or box extensions can be integrated into the design to address these concerns.

Conversely, placing the water resistive barrier inboard of the exterior insulation has been more difficult for contractors to adopt because of some significant departures from standard construction details and common construction sequences. These concerns increased when these techniques were applied to a building retrofit. This does have, however, the benefits of placing the water resistive barrier in a more protected location (increasing durability), and locating the window in the plane of the existing framing.

BSC developed details to serve as guidance on how to effectively maintain the continuity of the water management. These details are presented in Appendix A of this report.

1 Problem Statement

1.1 Introduction

The underlying concept of insulating the exterior of existing masonry walls and wood framed walls is simple; it has a variety of advantages for durability and air barrier continuity (Lstiburek 2007; Hutcheon 1964). Even though the practice should be simple, several problems stand in the way of widespread implementation. For example, manufacturers of cladding systems and exterior insulation materials often limit thicknesses to 1½ in. with their warranties; the cladding attachment, then, becomes an issue. This problem has been tackled by various practitioners (Crandell 2010; Ueno 2010; Joyce 2009; Pettit 2009; Straube and Smegal 2009). Demonstrations by members of the Building Science Corporation (BSC) research team, which carried out the work described in this report, have shown that up to 8 in. of exterior insulation over the exterior of wood framed buildings is possible (Lstiburek 2009). The engineering basis and support work, however, has not been conducted, resulting in obstacles for building official and building code acceptance. Additionally, water management strategies and procedures for integrating roofs, balconies, decks, and window systems have not been adequately developed. This gap also stands in the way of wider deployment.

In this research project, BSC developed baseline engineering analysis to support the installation of thick layers of exterior insulation (2 in. to 8 in.) on existing masonry walls and wood framed walls. Wood furring strips (fastened through the insulation back to the structure) were used as a cladding attachment location. Water management details necessary to connect the exterior insulated wall assemblies to roofs, balconies, decks, and windows were also created, resulting in guidance on integrating exterior insulation strategies with other enclosure elements. The details give consideration to both complete retrofit and phased retrofit approaches, furnishing connection details that allow for future integration with other high performance enclosure system elements.

1.2 Background

The existing residential building stock represents a significant portion of U.S. energy consumption. The residential and commercial building sectors consumed roughly 40% of the primary energy used in the United States in 2008. The residential sector consumed 21% and the commercial sector consumed 18% (U.S. Department of Energy, Energy Information Administration 2008). New construction represents only a small fraction of the total building stock in the country. The adoption of energy codes in many states has helped drive a move toward lower energy use buildings, but the existing building stock remains, for the most part, untouched.

In the past, retrofits of existing residential buildings typically involved the filling of framed cavity walls with insulation. The amount of effective thermal resistance that could be added, though, was limited by the existing stud cavity depth (wood framed walls) or strapping depth (common for mass masonry walls), the insulation material used (commonly fiberglass/mineral fiber or cellulose), and the amount of thermal bridging present from the wood framing.

Adding insulation to the exterior of existing buildings has been a method used by retrofit contractors to overcome these limitations and achieve higher effective R-values for wall

assemblies. The benefits of this approach extend beyond added thermal resistance; increased building durability and airtightness are often also realized.

BSC has been involved with numerous new construction and building retrofit projects that have used exterior insulation as part of the building energy use reduction strategy. Experience has shown that two primary questions are often raised:

- How will the cladding be attached?
- How will the water management of the assembly be accomplished?

1.3 Cost Effectiveness

In most circumstances, the exterior retrofit of a home with exterior insulation comes as part of a larger scope of work for a building retrofit. The choice to add exterior insulation is usually triggered by the need (or desire) to re-clad or overclad the building. The driving force behind installing new cladding can include existing water management problems, comfort or durability concerns, end of service life for the cladding, or aesthetic issues. The need to replace the cladding gives the designer or contractor an opportunity to include exterior insulation as a way to increase the energy performance of the building at the same time. The cost effectiveness of this from an energy perspective is therefore dependent on the cost of the insulation as well any associated components above and beyond the new cladding installation.

BSC completed a preliminary evaluation that looked at the incremental cost of the varying thicknesses of insulation installed to the exterior of the wall assemblies. This preliminary cost analysis used foil-faced polyisocyanurate (PIC) as the baseline exterior insulation. Cost data for the exterior insulation were taken from RSMeans Construction Data (Reed Construction Data 2011). Costs included in the analysis were the installed cost of the insulation material, 1 × 4 wood furring strips spaced at 16-in.on center (o.c.), and wood screws spaced at 24 in. o.c. vertically for the attachment of the furring back to the structure. A cost markup of \$100.00 per window was used in the reference model as an estimate of the additional cost for trim extensions that would be needed to account for the additional thickness of the exterior insulation. This value was estimated because actual costs can be highly variable. This variability results from the many different design choices available for window placement, exterior window trim design, and attachment.

Other items such as house wrap or sheathing tape, self-adhered membrane flashings, metal flashings, siding, and siding fasteners were omitted from the analysis. These items are associated with re-cladding and water management, and would be part of the retrofit project regardless of the addition of exterior insulation.

BSC ran simulations using Building Energy Optimization (BEopt) simulation software developed by the National Renewable Energy Laboratory. An example home was used as the baseline to help demonstrate the benefits of using exterior insulation as part of a house energy retrofit. This benchmark home was assumed to be around 1950's era two-story slab on grade construction. Table 1 gives its basic characteristics.

Table 1. Benchmark House Characteristics

House Characteristics	ft ²
Finished Floor Area	2,312
Ceiling Area	1,156
Slab Area	1,156
Wall Area	2,799
Window Area	410 (17.7% glazing ratio)

To examine the effectiveness of this single strategy, the wall conductance performance was isolated from all other aspects of the home. Given the assumed age of the home, the benchmark home had an uninsulated wall cavity (as per guidance from the 2011 Building America Benchmark Protocol).¹ The parametrics listed in Table 2 were run to see the effectiveness of the added thermal resistance in regard to the energy performance and utility cost.

Table 2. Parametric Steps and Cost

Parametric Step	Cost/ft ²
Benchmark (Uninsulated 2 × 4 Wall)	N/A
R-13 Cavity Fill Insulation	\$2.20
R-13 Cavity Fill + 1-in. Exterior Insulation (R-6.5)	\$3.55
R-13 Cavity Fill + 1.5-in. Exterior Insulation (R- 9.75)	\$3.76
R-13 Cavity Fill + 2-in. Exterior Insulation (R-13) + 1 × 4 Wood Furring	\$5.73
R-13 Cavity Fill + Two Layers of 1.5-in. Exterior Insulation (R-19.5) + 1 × 4 Wood Furring	\$7.19
R-13 Cavity Fill + Two Layers of 2-in. Exterior Insulation (R-26) + 1 × 4 Wood Furring	\$7.58
R-13 Cavity Fill + Four Layers of 2-in. Exterior Insulation (R-52) + 1 × 4 Wood Furring	\$11.07

Results indicated that for cold-climate zones (4 and higher), insulation up to 1.5 in. was a cost-optimized solution. This was mainly because this was the tipping point before which additional costs—associated with the furring strips and additional screw fasteners required for cladding attachment—needed to be added to the system. Insulation thicknesses up to 4 in. were demonstrated to be cost neutral as part of this simplified analysis in all cities except for Dallas, Texas (see Table 3 for reference cities). Insulation thicknesses up to 8 in. were demonstrated to be cost neutral, but only in cold-climate zones such as Boston, Massachusetts, and Duluth, Minnesota (see Appendix B for the results).

Although the analysis focused on conductance improvements only, some argument can be made that adding exterior insulation would likely also improve the overall airtightness of the assemblies (Ueno 2010). The benefits of increased airtightness are known to be very important in

¹ More information about Building America can be found at www.buildingamerica.gov.

cold-climate construction; however, it is also more difficult to isolate and apportion to individual measures.

Table 3. Reference Cities

City	Climate Zone
Dallas, Texas	3A
Kansas City, Missouri	4A
Boston, Massachusetts	5A
Duluth, Minnesota	7A

1.4 Other Benefits

Using exterior insulation has many additional benefits other than increased thermal resistance. The single largest benefit is the increased condensation resistance that this strategy provides for cold-climate buildings. The placement of the insulation to the exterior of the building acts to keep all of the structural elements at a much more even temperature throughout the year, reducing the risk of interstitial condensation. For wood structures, this can significantly reduce the potential for wood decay; an added benefit is that the seasonal thermal and moisture variations of the wood frame are greatly reduced. In masonry building, the potential for freeze thaw is practically eliminated because this approach not only keeps the masonry warmer, but also addresses exterior rain water absorption into the masonry (which is the leading moisture source related to freeze thaw damage to buildings).

In addition to keeping the structure warm and preventing condensation, the increase in drainage and drying that results from the 3/4-in. gap created by the furring strips offers additional protection against water infiltration problems (Lstiburek 2010). The benefit is significant enough that the use of furring strips is a base recommendation for all cladding installations whether exterior insulation is used or not. The fact that the furring strips are an intrinsic component of this system adds a significant benefit to the long-term durability of these wall assemblies.

2 Cladding Attachment Design

Attaching the cladding over exterior insulation encounters two common barriers:

- Cladding manufacturers that limit their warranties for installations of their cladding systems over only 1 in. to 1½ in. of insulation.
- Availability of fasteners that are long enough to fasten through the cladding and insulation, while still maintaining the required embedment depth into the structure, is limited.²

To overcome these constraints, furring strips have been added as a cladding fastening location for assemblies when thicker levels of exterior insulation are used (2 in. and greater). This addresses the cladding manufacturer's warranty and allows readily available fasteners and common cladding fastening procedures to be used.

For wood framed walls, long screws are used to attach the furring strips through the insulation back to the wood structure. For mass masonry walls an interim step is needed. To allow for an attachment point for the furring, wood 2 × 4 members (installed on the flat) are first attached to the masonry wall structure. The furring is then fastened back through the insulation to the 2 × 4 framing members with screws (see Figure 1).

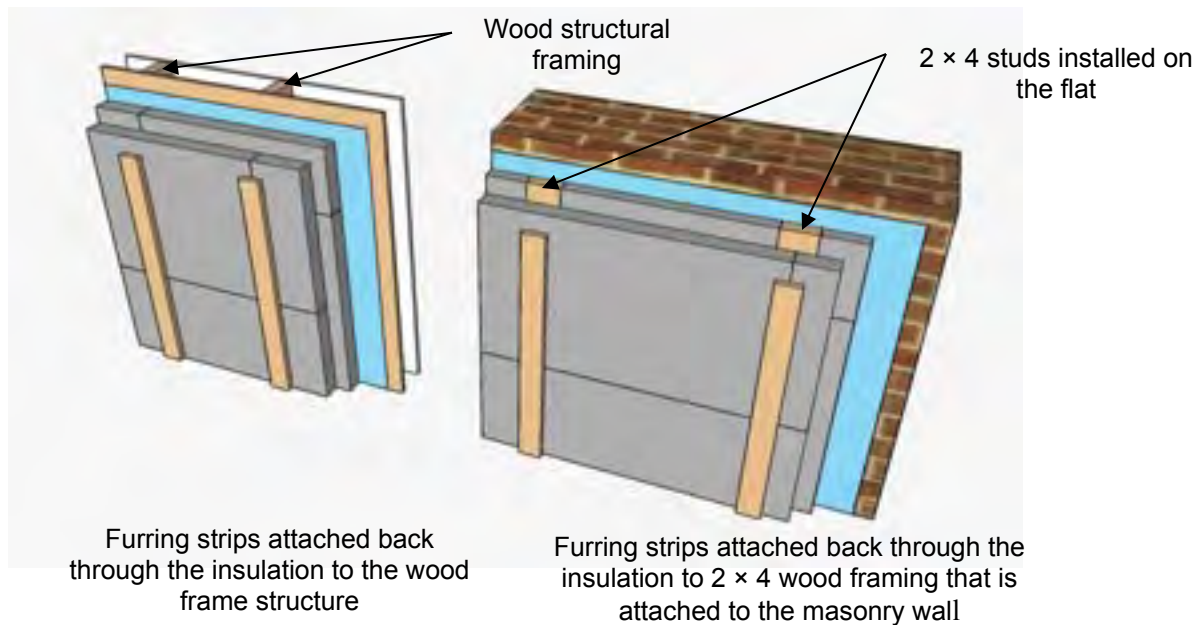

Figure 1. Recommended cladding attachment design

² Most pneumatic nail guns have a maximum fastener length limit of 3 in. to 3.5 in. This limits the amount of insulation that can be placed between the siding and the substrate in a direct siding application.

Attaching cladding to furring strips that are fastened back through the exterior insulation has been used on numerous Building America test homes and communities in both new and retrofit applications. This strategy has been proven to be an effective and durable way to attach cladding (BSC 2010; BSC 2009a; BSC 2009b). The lack of engineering data, though, has been a problem for many designers, contractors, and code officials. Concerns about sagging of the cladding from rotation of the fasteners and compression of the insulating sheathing are often raised.

2.1 Previous Research

Recently, studies undertaken by the Foam Sheathing Coalition (FSC), along with a joint research project by the New York State Energy Research and Development Authority (NYSERDA) and the Steel Framing Alliance (SFA) completed some testing and analysis to develop prescriptive code tables for attaching cladding to framing over continuous insulation. This work included conducting some laboratory testing of lateral load resistance for various configurations of cladding and furring types fastened through exterior insulation into wood or steel framed wall assemblies. Two criteria were evaluated when examining the connection performance: (1) overall strength of the connection and (2) acceptable deflection performance

The acceptable deflection limit is a performance requirement to limit the amount of vertical deflection that the installed weight of the cladding will induce on the furring strips. Excessive deflection could lead to concerns about gaps developing between the siding and other enclosure elements (such as windows, window trim, or other trim materials).

As part of the FSC and NYSEDA/SFA research, the acceptable deflection limit was set to a maximum of 0.015 in. (or 1/64 in.; Crandell 2010). The 0.015-in. deflection limit has a long-standing basis for wood connection design values used in the *National Design Specification for Wood Construction* (known as the NDS; American Forest & Paper Association [AF&PA] 2005). The FSC and NYSEDA/SFA research determined that in all cases the 0.015-in. deflection limit, not the average shear strength, controlled the design values for the capacities of the systems.

A secondary aspect of the FSC and NYSEDA/SFA research was to verify the accuracy of applying current engineering knowledge about wood to wood connections using the NDS Yield Theory (as detailed in *General Dowel Equations for Calculating Lateral Connection Values: AF&PA Technical Report 12* [TR-12]; AF&PA 1999) in predicting connection capacities. The researchers discovered that the 5% offset yield prediction as calculated using the TR-12 resulted in a reasonably accurate prediction of the shear load at a deflection of 0.015 in. Although there is no mathematical connection between these values, the investigators considered this an adequate basis for designing to a 0.015-in. deflection limit given the limited amount of research and funding that had been available to that point. In addition, a safety factor of 1.5 was added to the calculated results to address potential concerns of creep of materials under sustained loads. The choice of the 1.5 safety factor was based on several factors including precedence in the NDS and limited long-term deflection testing; however, a significant amount of uncertainty still surrounds the actual amount of predicted creep. Additional research is needed in this area.

This work resulted in the development of proposed code tables that set forth prescriptive requirements for attaching cladding over exterior insulating sheathing (see Figure 2). The table was developed using calculated results from the TR-12 supported by laboratory testing of a

representative but limited selection of various cladding attachment and fastener configurations. The table prescribes a maximum amount of insulation that can be installed based on maximum cladding weight, stud spacing, and vertical fastener spacing. This testing addressed attachments to wood and steel framing in addition to wood sheathing. Attachment to other materials such as masonry was not investigated.

**TABLE 8
FURRING MINIMUM FASTENING REQUIREMENTS
FOR APPLICATION OVER FOAM PLASTIC SHEATHING
TO SUPPORT SIDING WEIGHT^{1,2}**

Furring Material	Framing Member	Fastener Type and Minimum Size	Minimum Penetration into Wall Framing (inches)	Fastener Spacing in Furring (inches)	Maximum Thickness of Foam Sheathing (inches)						Allowable Design Wind Pressure (psf)		
					18°oc Furring ⁴			24°oc Furring ⁴			18°oc Furring	24°oc Furring	
					Siding Weight			Siding Weight					
3 psf	11 psf	25 psf	3 psf	11 psf	25 psf	3 psf	11 psf	25 psf					
Minimum 1x Wood Furring ³	Minimum 2x Wood Stud	Nail (0.120" shank, 0.271" head)	1-1/4	8	4	4	1.5	4	2	1	42.6	28.4	
				12	4	2	1	4	1.5	0.5	28.4	18.9	
				16	4	2	0.5	4	1	DR	21.3	14.2	
			Nail (0.131" shank, 0.281" head)	1-1/4	8	4	4	2	4	3	1	46.5	31.0
					12	4	3	1	4	2	0.75	31.0	20.7
					16	4	2	0.75	4	1.5	DR	23.3	15.5
		#8 wood screw ²	1	12	4	4	1.5	4	3	1	98.9	66.0	
				16	4	3	1	4	2	0.5	74.2	49.5	
				24	4	2	0.5	4	1	DR	35.1	23.4	
		1/4" lag screw ²	1-1/2	12	4	4	3	4	4	1.5	140.4	93.6	
				16	4	4	2	4	3	1	79.0	52.7	
				24	4	3	1	4	2	0.5	35.1	23.4	
Minimum 33mil Steel Hat Channel or Minimum 1x Wood Furring ³	33 mil Steel Stud	#8 screw (0.280" head)	Steel thickness +3 threads	12	3	1.5	DR	3	0.5	DR	52.9	35.3	
				16	3	1	DR	2	DR	DR	39.7	26.5	
				24	2	DR	DR	2	DR	DR	26.5	17.8	
		#10 screw (0.330" head)	Steel thickness +3 threads	12	4	2	DR	4	1	DR	62.9	41.9	
				16	4	1.5	DR	3	DR	DR	47.1	31.4	
				24	3	DR	DR	2	DR	DR	31.4	21.0	
	43 mil or thicker Steel Stud	#8 screw (0.280" head)	Steel thickness +3 threads	12	3	1.5	DR	3	0.5	DR	69.0	46.0	
				16	3	1	DR	2	DR	DR	51.8	34.5	
				24	2	DR	DR	2	DR	DR	34.5	23.0	
		#10 screw (0.330" head)	Steel thickness +3 threads	12	4	3	1.5	4	3	DR	81.9	54.8	
				16	4	3	0.5	4	2	DR	61.5	41.0	
				24	4	2	DR	4	0.5	DR	35.1	23.4	

- For SI: 1" = 25.4 mm; 1 pound per square foot (psf) = 0.0479 kPa. DR = design required
- Table values are based on: (1) minimum 3/4-inch (19.1 mm) thick wood furring and wood studs of Spruce-Pine-Fir or any softwood species with a specific gravity of 0.42 or greater per AF&PA/NDS, (2) minimum 33 mil steel hat channel furring of 33 ksi steel, and (3) steel framing of indicated nominal steel thickness and minimum 33 ksi steel for 33mil and 43 mil steel and 50 ksi steel for 54 mil steel or thicker. Steel hat channel shall have a minimum 7/8-inch (22.2 mm) depth.
 - Fasteners shall comply with appropriate standards and manufacturer's installation instructions, or be otherwise approved for the intended application.
 - Where the required siding fastener penetration into wood material exceeds 3/4 inch (19.1 mm) and is not more than 1-1/2 inches (38.1 mm), a minimum 2x wood furring shall be used unless approved deformed shank siding nails or siding screws are used to provide equivalent withdrawal strength allowing connection to 1x wood furring.
 - Furring shall be spaced a maximum of 24"oc in a vertical or horizontal orientation. In a vertical orientation, furring shall be located over wall studs and attached with the required fastener spacing. In a horizontal orientation, furring strips shall be fastened at each stud intersection with a number of fasteners equivalent to the required fastener spacing. In no case shall fasteners be spaced more than 24 inches (0.6 m) apart.
 - Lag screws shall be installed with a standard cut washer. Lag screws and wood screws shall be pre-drilled in accordance with AF&PA/NDS. Approved self-drilling screws of equal or greater shear and withdrawal strength shall be permitted without pre-drilling.
 - Refer to Appendix D for additional requirements related to use of this table.

Figure 2. Table 8 excerpt from Crandell (2010)
(Used with permission)

The results of this earlier research laid a good foundation for guidance on cladding attachment. Several key questions were answered; however, the work has led to other questions about the deflection of the furring strips:

- What is the impact of different insulation materials?
- What is the impact of increased thicknesses beyond 4 in.?
- What is the impact of prolonged loading?

To answer these questions, BSC designed the research described in this report. The BSC research team examined the problem using engineering numerical analysis and laboratory testing of cladding attachment using furring strips. The analysis examined the ability of the system to resist wind withdrawal loads, initial (short-term) gravity loading, and prolonged (long-term) gravity loading of cladding systems.

The numerical analysis portions were completed following standards set out in the 2005 NDS (AF&PA 2005) and the TR-12 document (AF&PA 1999). The numerical analysis examined both wind withdrawal load and vertical gravity load resistance of the assemblies.

Laboratory testing was designed to examine short-term as well as long-term loading performance for several common types of exterior insulation materials. Table 4 lists the materials used in each of the tests conducted.

Table 4. Insulation Materials

Insulation Type	Product	Brand
Type II Expanded Polystyrene (EPS)	Plastispan	Plastifab
Type IV Extruded Polystyrene (XPS)	C-200	Owens Corning
Foil-Faced PIC	Thermax CI	DOW Chemical
Rigid Mineral Fiber	RB80	Roxul

The laboratory work was also designed to expand on insulation thicknesses using 4-in.-thick material (two layers, 2 in. thick) for the baseline tests. Additional testing of 8-in.-thick material (four layers, 2 in. thick) was conducted. Other variables such as stud spacing, furring strip dimensions, and fastener types were maintained across each test; however, different fastener types were needed for thicker insulation installations.

2.2 Wind Load Resistance

Wind load withdrawal resistance is a function of the fastener withdrawal capacity and is independent of the length of the fastener. As a result, insulation thickness has no bearing on the withdrawal capacity of the fastener. Withdrawal capacities of fasteners have been well studied and documented. Design capacities can be determined following design guidelines set out in the 2005 NDS (AF&PA 2005). Because of this, no laboratory testing was deemed to be necessary.

2.2.1 Numerical Analysis

Fastener withdrawal resistance was evaluated under Chapter 11, “Dowel-Type Fasteners” of the 2005 NDS (AF&PA 2005). The withdrawal strength is determined by the following equations:

$$W = 1800 \cdot G^{3/2} \cdot D^{3/4} \quad (\text{for lag screw attachment})$$

$$W = 2850 \cdot G^2 \cdot D \quad (\text{for wood screw attachment})$$

$$W = 1380 \cdot G^{5/2} \cdot D \quad (\text{for nail and spike attachment})$$

where

W = Withdrawal strength (per inch of embedment)

G = Specific gravity of wood

D = Unthreaded diameter.

To be consistent with earlier research, Spruce-Pine-Fir (SPF) or any other softwood species with a specific gravity of 0.42 per the 2005 NDS was used as the minimum in the calculation. Wood members with higher specific gravity numbers will result in increased capacity. Design values were calculated for the common fastener types listed in Table 5.

Table 5. Design Withdrawal Values for Various Common Screw Fasteners

Fastener Type	Unthreaded Shank Diameter (in.)	Withdrawal Capacity per Inch of Thread Penetration
#8 Wood Screws	0.164	82 lb
#10 Wood Screws	0.190	96 lb
#12 Wood Screws	0.216	109 lb
¼-in. Lag Screws	0.250	173 lb

The calculated withdrawal values were multiplied by the adjustment factors given in Table 6 as outlined in *Table 103.1 Applicability of Adjustment Factors for Connections* (NDS 2005) per the 2005 NDS to determine the allowable stress design (ASD) adjusted design values.

Table 6. Adjustment Factors

Adjustment Factors		
Load Duration Factor	CD =	1.6
Wet Service Factor	CM =	1.0
Temperature Factor	Ct =	1.0
End Grain Factor	Ceg =	1.0
Toe-Nail Factor	Ctn =	1.0

The results were tabulated based on horizontal spacing of furring strips and vertical spacing of the fasteners (see Table 7).

Table 7. Allowable Design Wind Pressure (psf)

	#8 Wood Screw		#10 Wood Screw		#12 Wood Screw		¼-in. Lag Screw	
	Furring Spacing (in.)		Furring Spacing (in.)		Furring Spacing (in.)		Furring Spacing (in.)	
Vertical Fastener Spacing	16	24	16	24	16	24	16	24
8 in.	148	99	172	115	195	130	301	200
12 in.	99	66	115	76	130	87	200	134
16 in.	74	49	86	57	98	65	150	100
24 in.	49	33	57	38	65	43	100	67

2.3 Gravity Load Resistance

Unlike the wind load resistance and the fastener withdrawal values, the lateral load capacity of wood furring installed over exterior insulating sheathing does not have well-defined guidance. To evaluate the lateral load capacity of furring strips installed over insulation as a cladding attachment system, laboratory testing and computational analyses were completed.

2.3.1 Numerical Analysis

Using the FSC and NYSERDA/SFA research as a starting point (Crandell 2010), the 5% offset yield values were calculated for various insulation thickness using the methodology set out in the TR-12 document (AF&PA 1999). Six modes of failure are evaluated in the general dowel equations (Table 8). The failure modes are functions of either crushing (bearing failure) in the wood members or bending (yielding) of the dowel fastener. An example of a mode IV failure (dowel yielding in the side and main member) can be seen in Figure 3.

Table 8. Yield Modes from AF&PA TR-12





Yield Mode	Description	Graphic
I_m	Main Member Bearing Failure	
I_s	Side Member Bearing	
II	Side and Main Member Bearing	
III_m	Main Member Bearing and Dowel Yielding in the Side Member	
III_s	Side Member Bearing and Dowel Yielding in the Main Member	
IV	Dowel Yielding in the Side and Main Member	

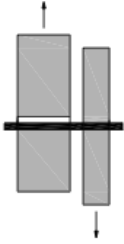
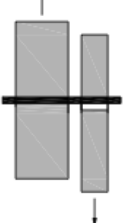

Figure 3. Example of fastener yielding in Mode IV

Four types of screw fasteners were used (#8 wood screw, #10 wood screw, #12 wood screw, and ¼-in. lag screw). These four are the most common fasteners expected to be used for attaching wood furring back to the structure.

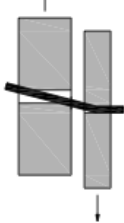
A minimum penetration depth of 1.5 in. was assumed for all fasteners into the primary support member. A 0.75-in. bearing of the fastener in the furring was assumed. Similar to the withdrawal capacity calculations, the minimum specific gravity of both the wood stud and the wood furring strip was set to 0.42.

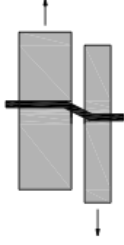
Nominal design values (values before any safety factors are applied) for each of the baseline fasteners used are given in Table 9 through Table 12. The design value is the lowest yield limit for all of the failure modes evaluated. For most cases, yield mode IIIs governs, except for #8 wood screws where for larger gaps, yield mode IV governs (see dashed red lines in tables). These calculated results are consistent with observed yield failures noted during laboratory testing.

Table 9. Nominal 5% Offset Limit (lb) at Connection Yield Mode for #8 Wood Screws

Gap (in.)	Im	Is	II	III _m	III _s	IV
1	565	414	128	141	66	75
2	565	414	90	96	40	42
3	565	414	69	72	29	28
4	565	414	56	57	22	22
5	565	414	47	48	18	17
6	565	414	40	41	15	14
7	565	414	35	36	13	12
8	565	414	32	32	12	11

Table 10. Nominal 5% Offset Limit (lb) at Connection Yield Mode for #10 Wood Screws

Gap (in.)	Im	Is	II	IIIIm	IIIIs	IV
1	656	479	148	170	80	101
2	656	479	104	116	49	57
3	656	479	80	87	35	39
4	656	479	65	70	27	30
5	656	479	54	58	22	24
6	656	479	47	50	19	20
7	656	479	41	43	16	17
8	656	479	37	38	14	15

Table 11. Nominal 5% Offset Limit (lb) at Connection Yield Mode for #12 Wood Screws

Gap (in.)	Im	Is	II	IIIIm	IIIIs	IV
1	747	545	169	208	97	143
2	747	545	119	142	59	83
3	747	545	91	107	42	57
4	747	545	74	85	33	44
5	747	545	62	71	27	35
6	747	545	53	61	23	29
7	747	545	47	53	20	25
8	747	545	42	47	17	22

Table 12. Nominal 5% Offset Limit (lb) at Connection Yield Mode for ¼-in. Lag Screws

Gap (in.)	Im	Is	II	IIIIm	IIIIs	IV
1	1221	882	275	322	151	201
2	1221	882	193	220	92	115
3	1221	882	148	165	66	79
4	1221	882	120	132	51	60
5	1221	882	101	110	42	48
6	1221	882	87	94	35	40
7	1221	882	76	82	31	34
8	1221	882	68	73	27	30

2.3.2 Short-Term Deflection Testing Protocol

The short-term (or initial loading) test method was designed to emulate whole-wall system effects in that the tests were conducted on full height assemblies (see Appendix C for the full test protocol). The intent was to minimize variations in the installation of a single fastener by

distributing the load over multiple fasteners (in these tests, 14 fasteners were used for each test panel). The test panels were 8-ft tall by 4-ft wide and anchored to a masonry block wall (see Figure 4). Each test panel consisted of the following:

- 2 × 4 wood studs at 24-in o.c.
- ¾-in. oriented strand board (OSB) sheathing
- Building wrap
- 4-in. or 8-in. exterior insulation (two or four layers of 2-in.-thick material with joints offset)
- 1 × 3 wood furring fastened back to the studs with #10 wood screws at a 16-in. o.c. vertical spacing (14 fasteners total per panel).



Figure 4. Short-term deflection test panel

The furring strips were loaded with a hydraulic ram, bringing up the load on the wall assembly to a specific target load and recording the deflection. The load was then released to examine the amount of plastic deformation created in the system to that point. The system was then reloaded up to the next target load and the protocol repeated. Table 13 gives the target loads. The hysteresis plots created by the loading and unloading of the test panels were designed to examine the amount of plastic deformation induced into the assembly at each load increment (see Figure 5).

Table 13. Target Loads for Short-Term Deflection Testing

Total Load (lb)	Load/ft ² (lb)	Load/Fastener (lb)
120	3.8	8.6
370	11.6	26.4
500	15.6	35.7
750	23.4	53.6
1,000	31.3	71.4

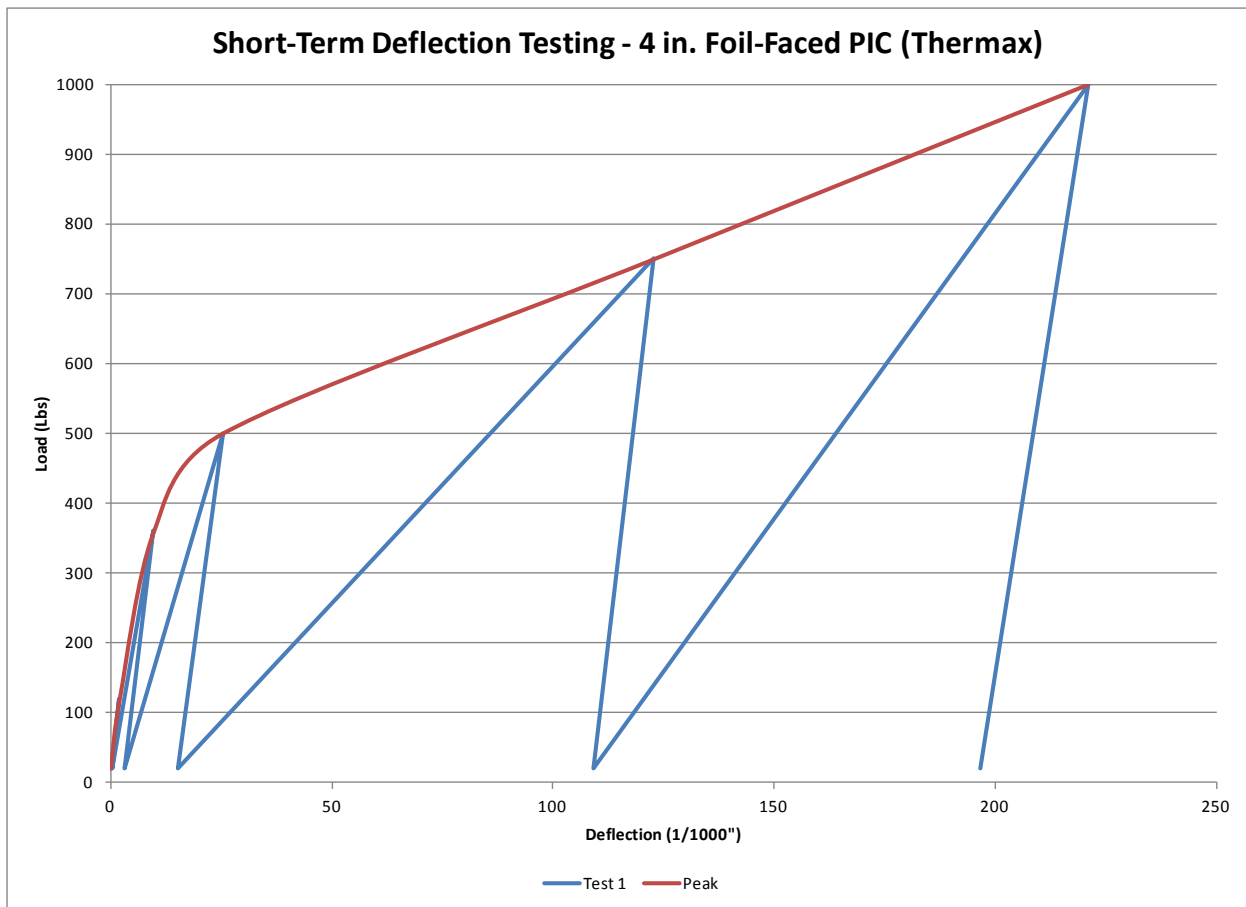

Figure 5. Example hysteresis test plot for short-term deflection testing

2.3.3 Long-Term Test Protocol

For the long-term testing, the test setup was reduced to a single furring because of space constraints and issues with equal load share over two furring strips with fixed dead weights (see Appendix D for the full test protocol). The test panels were 8-ft tall by 16-in. wide and anchored to a masonry block wall (see Figure 6). Each test panel consisted of the following:

- 2 × 4 wood stud (single stud)
- 3/8-in. OSB sheathing
- Building wrap
- 4-in. exterior insulation (two layers of 2-in. material with joints offset)
- 1 × 3 wood furring fastened back to the stud with #10 wood screws at 16 in. o.c. vertically (7 fasteners total per panel).



Figure 6. Long-term deflection test panel

The furring strips were loaded with a 213-lb dead weight (see Figure 7). Deflection readings were taken every 30 s during the initial loading of the test panels and several times during the first day of loading. After the first day, readings were typically taken each day for the following

month, and then every few days thereafter. Temperature and relative humidity (RH) readings were also recorded.



Figure 7. Dead weights attached to bottom edge of furring strips

2.3.4 Results and Discussion

2.3.4.1 Short-Term Deflection Testing

Figure 8 and Figure 9 summarize the results of the short-term deflection testing. The deflection recorded is the vertical movement differential between the OSB sheathing and the furring strips (averaged between the two furring strips). Overlaid on the charts are the ranges of weights by cladding types commonly used in the industry. In addition, the common deflection gap sizing is highlighted for reference.

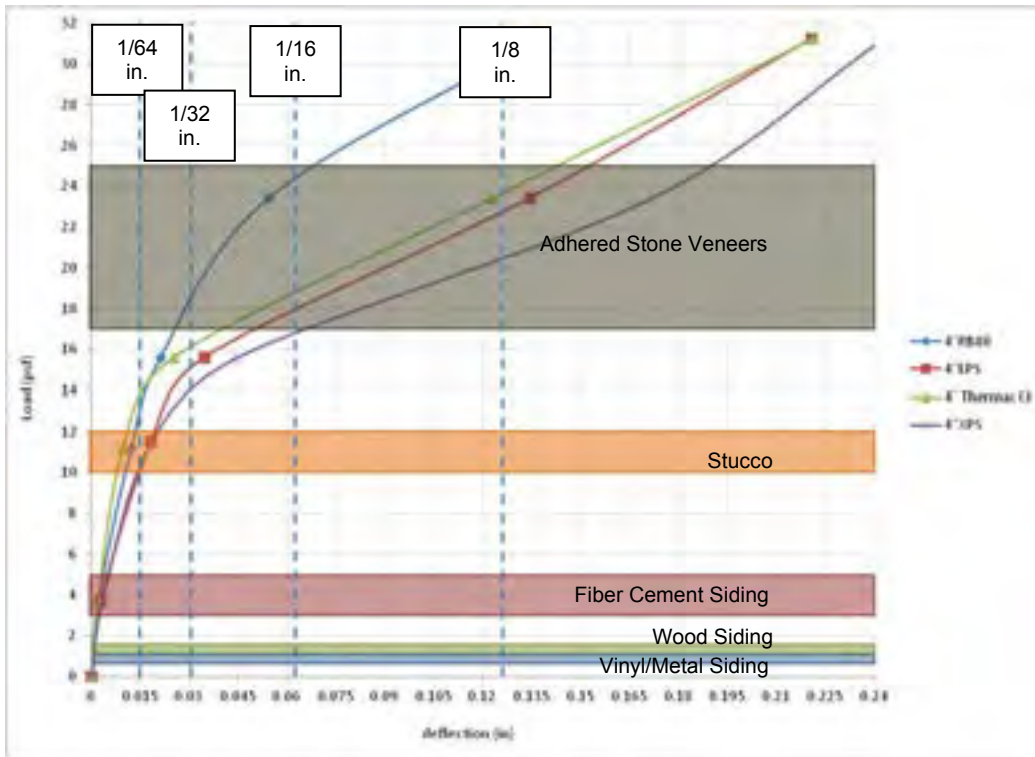

Figure 8. Short-term deflection testing results (4-in.-thick insulation)

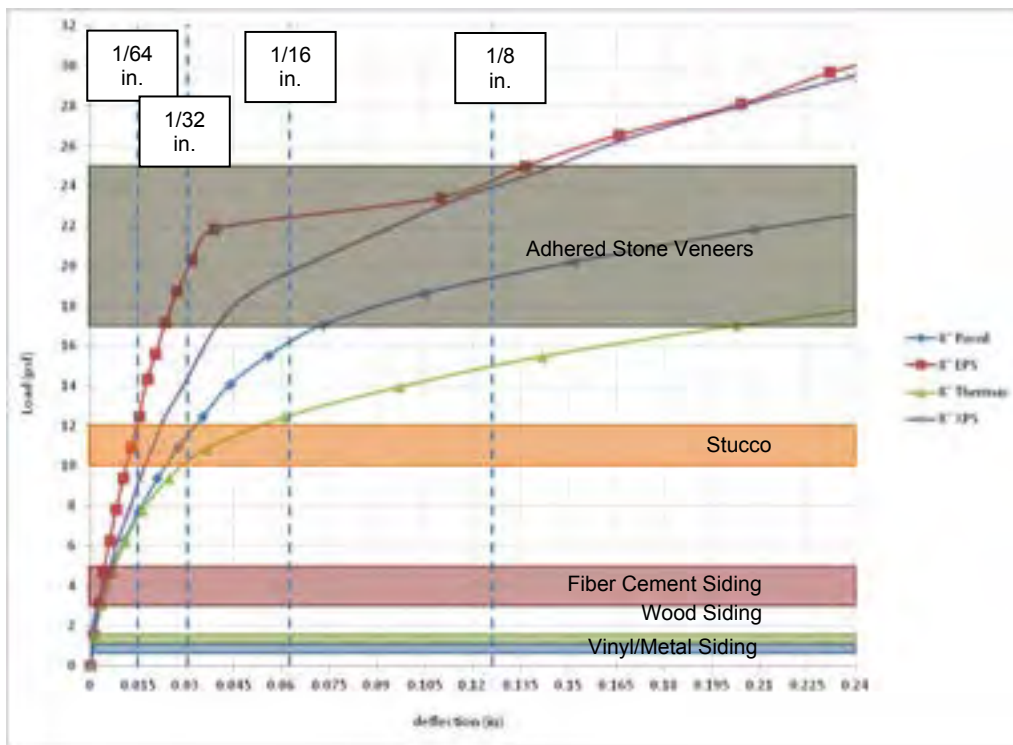

Figure 9. Short-term deflection testing results (8-in.-thick insulation)

The capacity of the system was developed from several sources including the bending strength of the fastener, the bearing strength of the furring and framing members, and the compressive strength of the rigid insulation, as well as other factors such as static friction between layers (see Figure 10).

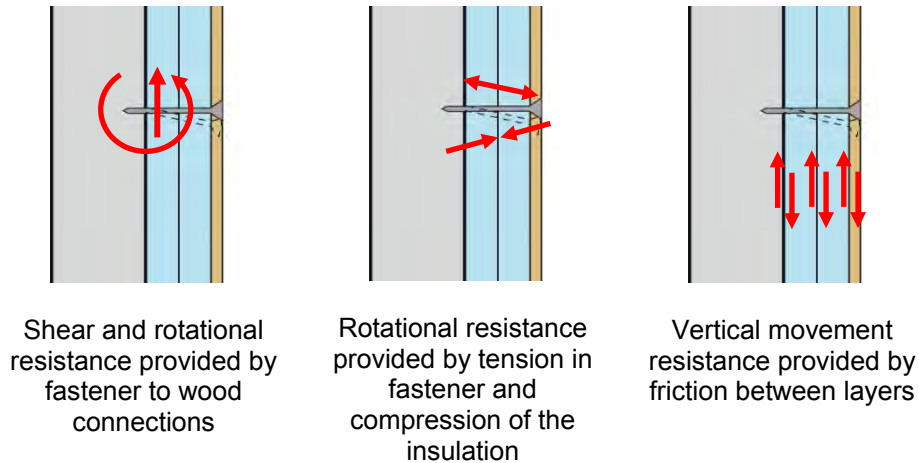

Figure 10. Forces providing vertical displacement resistance

Under initial loading, the load is taken up by the bending of the fasteners as well as the pre-compression forces induced on the insulation by the tightening of the furring. As the vertical load increases, a greater portion of the load will be placed on the insulation through increased compression. The increased compression load results from the bending and rotation of the fasteners, which creates a normal force on the insulation.

The deflection testing showed that friction between the various layers is reasonably significant in the development of the system capacity. During most of the tests conducted, slippage between layers occurred as the vertical load overcame the static friction between the layers. This resulted in jumps in the deflection readings. Slippage occurred between the layers in products with smoother surfaces; however, slippage was not seen for products with rougher surfaces such as the rigid mineral fiber insulation.

Because several factors are acting together to develop the system capacity, there is no linear relationship of system capacity to number of fasteners. In simpler terms, doubling the number of fasteners will not result in a doubling of system capacity. Also, because a portion of the capacity is based on compression forces on the exterior insulation from both rotational resistance as well as static friction resistance, variations in installation practices may have impacts on the initial capacity of the system until the insulation compression and static friction is developed.

Based on the system configuration used in the test setup (fasteners spaced 24-in. o.c. horizontally and 16-in. o.c. vertically), the deflection resulting from the dead weight for metal, vinyl, wood, and fiber cement siding would be approximately 0.005 in. (1/200 in.) or less for insulation thicknesses up to 8 in. For all practical purposes, deflections in this range could be considered as zero deflection because of other factors such as material tolerances, construction tolerances, and thermal expansion and contraction movement. In addition, moisture expansion and contraction movements are greater in magnitude for the materials under consideration.

For stucco cladding systems, the amount of deflection anticipated would still be small (less than 1/32 in. for up to 4 in. of insulation and less than 1/16 in. for up to 8 in. of insulation). Note that this initial deflection would happen before the stucco mortar was hydrated and would not cause cracking of the solid stucco systems later. For cracking concerns, long-term movement of the system would need to be reviewed.

For adhered stone veneers, the anticipated deflection given the stud spacing and fastener spacing used in the test begins to become more of a concern. Movement in excess of 1/8 in. for 4-in.-thick layers of insulation and 1/4 in. for up to 8 in. of insulation could be possible with very heavy stone and thick mortar layers. The capacity of the system could be increased by using closer stud spacing and closer vertical spacing of fasteners; however, a linear interpolation based on capacity per fastener may not yield the most accurate results because other factors are not considered in this simplification as discussed previously.

The effects of insulation type did not appear to have a significant effect on the developed capacity of the systems. The relative performances of the types of insulation changed between the 4-in. tests and the 8-in. test. For example, the PIC insulation had the second highest capacity for the 4-in. test, but the lowest measured capacity for the 8-in. test. It is probable that variances in installation practices have a greater impact on the performance than the type of insulation material used.

Examination of the data shows that at 0.015-in. deflection (1/64 in.), the capacities of the systems are around 10 psf (23 lb per fastener) for EPS and XPS and around 13 psf (29 lb per fastener) for PIC and mineral fiber insulation at a thickness of 4 in. As determined by the protocol in the TR-12 (AF&PA 1999), the predicted value for #10 wood screws with a 4-in. gap is 27 lb. The results correlate reasonably well with the findings of the FSC and NYSERDA/SFA research (Crandell 2010). For the 8-in. deflection testing there was a wider range of results at the 0.015-in. deflection. Capacities were measured between 7 psf (16 lb per fastener) for mineral fiber and PIC, 9 psf (21 lb per fastener) for XPS, and 12 psf (27 lb per fastener) for EPS. As determined by the protocol in the TR-12, the predicted value for #10 wood screws with an 8-in. gap is 14 lb. The predicted value was at the low end of the measured data, and the actual measured capacity was always higher.

2.3.4.2 Long-Term Deflection Testing

Figure 11 highlights the results of the long-term deflection testing. Overlaid on the chart are common deflection measurements. The systems were loaded with an ultimate load of 213 lb (13 psf at 24-in. o.c., 20 psf at 16 in.). The weight was chosen to be representative of heavier stucco (10 psf to 12 psf) or adhered stone veneer (17 psf to 25 psf) claddings. An additional test using XPS insulation was conducted with a dead weight of 53 lb (3 psf at 24-in. o.c., 5 psf at 16-in. o.c.) to see if the creep effects differed under small loading. This test was designed to simulate fiber cement cladding installation.

For all tests (other than the PIC sample) the long-term deflection values were less than or right around 1/32 in. after loading for 6 months. The deflection noted with the PIC sample seemed to be demonstrating more potential for ongoing creep. The maximum deflection reached 3/32 in. after 6 months with a relatively consistent movement trend.

There is some concern with the results of the PIC test. Two spikes in the deflection of the PIC were correlated with construction activities on the wall immediately adjacent to the PIC test setup. These construction activities were assumed to cause these spikes. Because of this, additional deflection noted in the PIC setup may result from the proximity of the test setup to other laboratory equipment and testing activities and not purely from creep effects of the insulation.

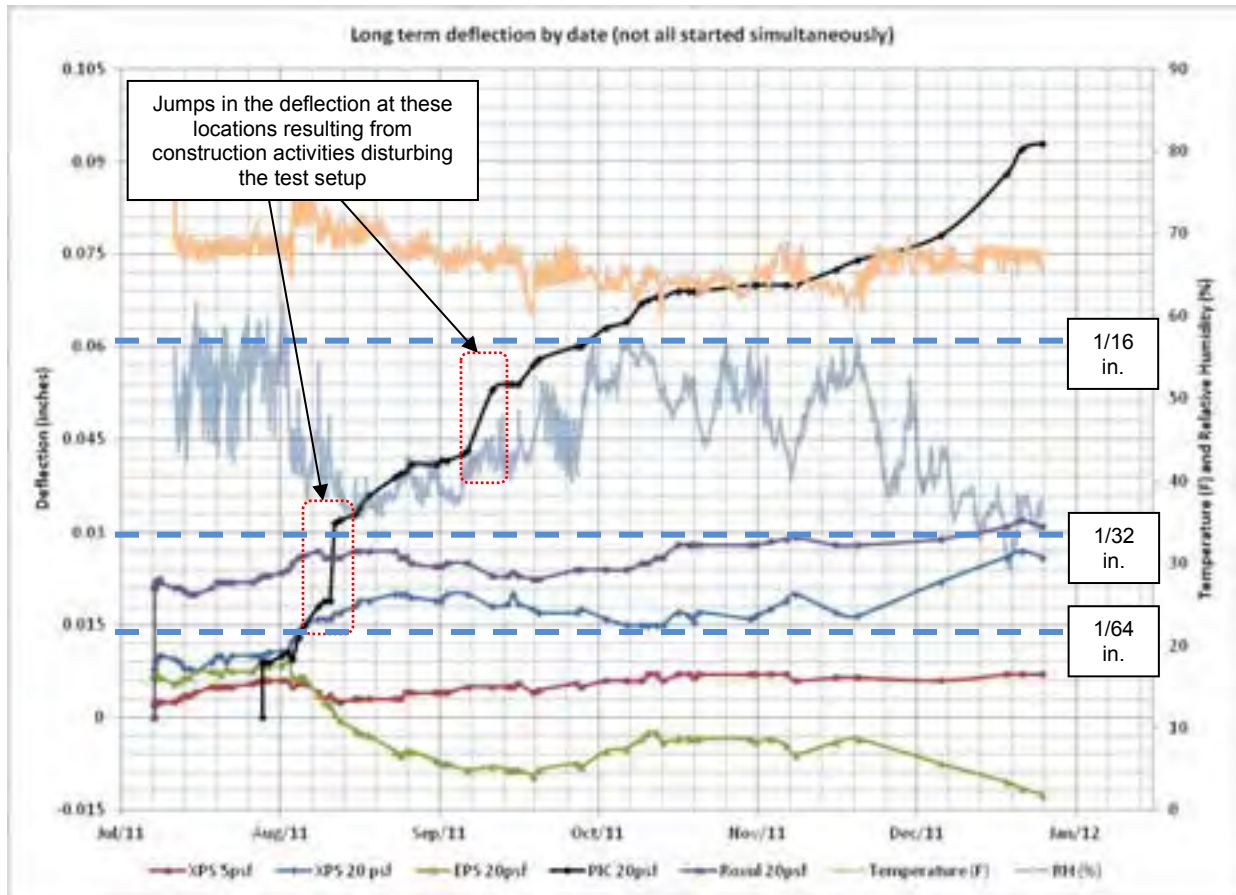

Figure 11. Deflection of furring strips under sustained load

In the early stages of the testing (the first 3 weeks after the initial loading), very minor additional downward vertical movement was seen. The temperature and RH, however, were maintained at a more stable range. In all cases a very slight trend for additional deflection can be seen. The magnitude, though, was on the order of 0.0025 in. (1/400 in.), and it might not result from creep effects from sustained loading. More substantial movement seemed to occur shortly after the first 3 weeks, when the temperature in the laboratory increased slightly (by approximately 5°F) and the RH dropped (from approximately 55% RH to 40% RH). Movements on the order of 0.01 in. or 1/100 in. were observed.

Looking at the complete data set, a slight trend in the movement appears to result from fluctuations in the temperature and RH. The temperature in the laboratory space fluctuated between 60°F and 75°F and the RH fluctuated between 60% and 30% over the course of the testing. Deflection movement in the test setups seems to track to these environmental changes. A

drop in the RH results in a general trend of an increase in the vertical downward deflection of the furring strips. It is interesting to note that the converse is true as well. An increase in the RH seems to correspond to an upward vertical movement of the furring strips. This was true for all insulations except for EPS. The movement of the EPS test panel demonstrated a reverse trend, where a drop in the RH resulted in an upward vertical movement of the furring strips.

The test conducted at 5 psf on the XPS sample demonstrated very stable performance with almost no movement seen in the sample even with changing temperature and RH.

From the test data, it is difficult to differentiate movements of the samples that result from prolonged loading (creep) or from environmental changes. Both positive as well as negative movements were noted. The movements from environmental changes are most likely caused by material expansion and contraction from moisture adsorption or thermal changes. Given the limited testing, the magnitude of this effect cannot be predicted at this point. In addition, material property changes may affect performance over the range of actual in-service temperatures. This was not accounted for in the testing. Additional testing of exterior samples exposed to a variety of temperature and humidity conditions is recommended.

2.3.5 Recommendations

The work conducted by NYSERDA/FSA used an initial deflection limit of 0.015 in. as a basis for design (Crandell 2010). By limiting the initial deflection to 0.015 in., the intent was to keep long-term deflection caused by potential creep of the system within acceptable limits, although these acceptable limits were not defined. As an actual ultimate design criteria, the initial 0.015-in. deflection limit (short-term) should not be confused with the in-service acceptable deflection (initial and long-term combined).

Based on experience, past research and testing, and the results of the laboratory work, a 1/64-in. deflection limit as an in-service standard is too conservative for most practical purposes. Such a small movement would not be able to be detected in board and siding installations. For other cladding such as adhered stone veneers and stucco, the initial deflection is not as significant an issue because the mortars have not been hydrated and the cladding is a viscous fluid (and not solid) when the initial movement takes place. Once the stucco and adhered stone veneers have cured, though, further movement may become a concern.

Acceptable deflection limits, then, need to be specific to the type of cladding. For lap sidings and panel claddings with joints (metal, vinyl, wood, and fiber cement), the movement is aesthetic in nature and not a health and safety issue. The acceptable amount of deflection will be a function of acceptable aesthetics for the cladding system chosen. For most lap siding or panel cladding systems, variations up to 1/16 in. or even 1/8 in. may be acceptable because the material and installation tolerances are easily greater than the potential gap development. As a result, it is recommended that the deflection be limited to 1/16 in. in service unless it is demonstrated that larger deflections can be tolerated.

For brittle claddings (such as stucco and cultured stone), movement could lead to cracking and potentially spalling of the material. For these systems it is recommended that the service deflection limit be set to prevent deflection that may damage the cladding or impair its function. For brittle claddings, a limit of 1/64 in. is proposed after initial deflection.

Most common residential cladding systems (metal, vinyl, wood, and fiber cement) are lightweight enough (<5 psf) that attachment to furring over any thickness of insulation does not create an issue. For these cladding systems the predicted deflection—based on a reasonable horizontal spacing (16-in. to 24-in. o.c.) and vertical fastener spacing (up to 24-in. o.c.)—is so slight (1/200 in.) and creep effects are so minimal that the deflection does not approach the proposed 1/16-in. maximum in-service limit.

For heavier cladding systems (>10 psf), initial deflection is within the proposed deflection limit. Information about potential thermal and moisture expansion and contraction movements, as well as creep effects of certain insulation materials in exposed environments, is inadequate for predicting long-term in-service deflection. Additional research into the long-term deflection movement of heavier claddings in exposed environments is needed.

3 Water Management Details

The use of exterior insulation has been a stumbling block for many designers and contractors. Even though the concept is simple, the details required to maintain continuity of the water management system can often be confusing.

At the most basic level there are two choices. The water management of the assembly is maintained by either placing the water resistive barrier (WRB) interior of the insulation or exterior of the insulation. The choice of where it will be applied is a complex one and requires consideration and weighing of many factors.

For the most part, placing the WRB to the exterior of the insulation has been the easier of the two approaches because the details are largely similar to standard construction practices. Concern is often raised about how to support elements that once were positioned in the structural frame wall, which are now “pushed” outward into the plane of the exterior insulation (e.g., windows and step flashings).

Conversely, placing the WRB inboard of the exterior insulation (see Figure 12) has been more difficult for contractors to adopt because of some significant departures from standard construction details and common construction sequences. These concerns increased when these techniques were applied to a building retrofit. This placement has benefits, however, in that the WRB is placed in a more protected location (increasing durability) and the window is located in the plane of the existing framing. With either choice, specific details are required to maintain the continuity of the WRB at the connection of the wall assemblies with other building elements such as foundations, roofs, porches, decks, windows, and doors.



Figure 12. Typical exterior retrofit detail, showing furring strip cladding attachment

Details were developed to serve as guidance on effectively maintaining the continuity of the water management. The matrix of details is broken down into two primary categories:

Wood framed wall construction

- Lap siding
- Building paper
- Board sheathing
- 2 × 4 wood studs
- Interior lath and plaster.

Mass masonry construction

- 3-wythe mass masonry wall
- ¾-in. vertical wood furring
- Interior lath and plaster.

A multitude of variations are possible but the BSC team felt that these two baseline assemblies were representative of housing structures that are currently targeted for energy retrofits. By extension, the details are not intended to cover all possible scenarios that a designer, contractor, or homeowner might encounter. Instead, they are intended to inform and guide choices by illustrating and discussing the intended goals of the retrofit.

3.1 Exterior Insulation Materials

The primary focus of this research is to examine the installation of exterior rigid insulation. Exterior rigid insulation material is generally separated into four product categories³:

- Foil-faced PIC
- XPS
- EPS
- Rigid mineral fiber (fiberglass or rockwool).

Exterior insulation can be installed in a single or multiple layers (see Figure 13). The number of layers will depend on the overall amount of insulation in the design and the available product thicknesses. Installations 2 in. and less will typically be done in a single layer. Installations greater than 2 in. are more commonly done in multiple layers. When multiple layers are used, BSC recommends offsetting the joints both horizontally and vertically to minimize the effects that gaps at the board edges may have on the thermal performance of the insulation.

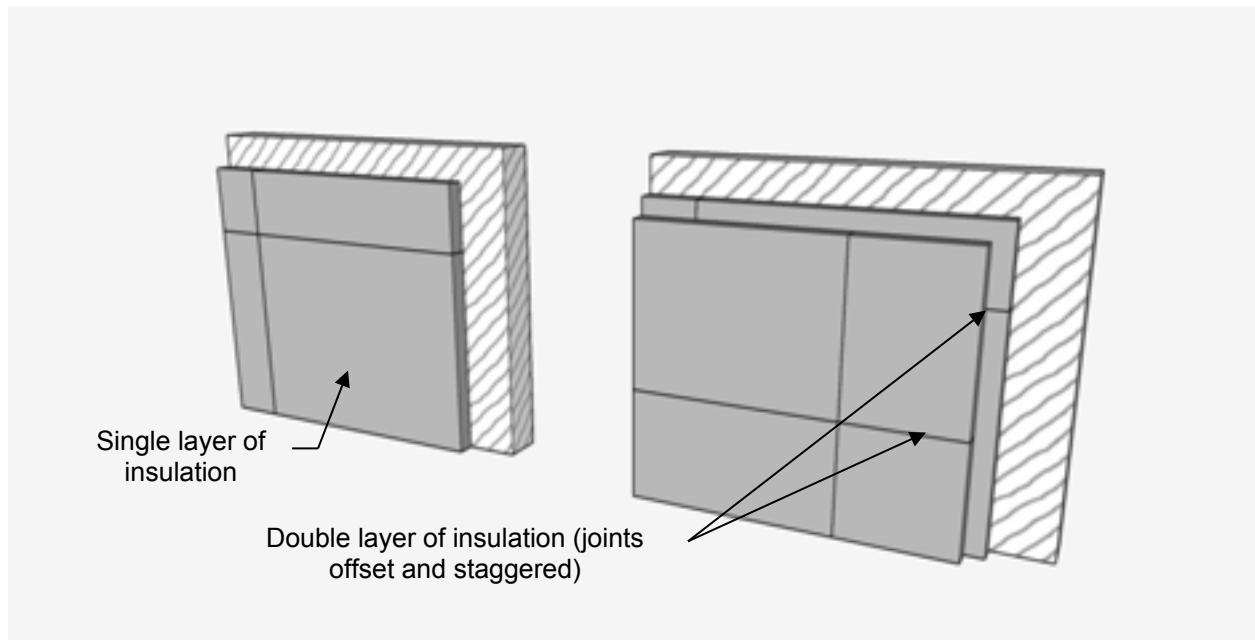

Figure 13. Layering patterns of exterior insulation

³ The authors of this research also acknowledge and support the use of exterior closed cell spray polyurethane foam as an exterior insulation approach. This approach is not discussed in this document because it was outside the scope of this research.

3.2 Water Resistive Barrier

The WRB is generally located either between the insulation and the wall structure or to the exterior of the insulation behind the cladding. A third option of placing the WRB in between two layers of insulation is also possible, but this is uncommon and can lead to significant confusion and coordination problems during construction. Although the third option can be used, it generally does not create any significant advantages that would justify the problems it might cause. The choice of the location of the WRB will affect many other enclosure connection details. The strategy should be clear and consistent throughout the entire project.

The most common WRBs in the residential market today are building or house wraps, which are mechanically attached using nails or staples. Although fully adhered air barrier membranes (which can often perform the functions of a WRB) have been widely used in the commercial market, they have only recently become more common in residential construction. Manufacturers are developing and marketing residential-grade versions (permeable and impermeable) of these self-adhered membranes.

Another application that is becoming more prevalent is using liquid applied membranes that are sprayed, rolled, or brushed onto the exterior sheathing. Finally, using exterior insulation products as WRBs is becoming more and more popular. Many manufacturers currently have ICC Evaluation Service approvals for their products to be listed as WRBs. Of the insulation products mentioned previously, only foil-faced PIC and XPS are currently recommended for use as WRBs through taping and sealing of the joints with sheathing or other compatible construction tape or self-adhered membrane flashing. This is an important consideration when choosing an insulation product and water management strategy. With thinner insulation thicknesses, adding a building wrap over top of the insulation can allow the drainage plane of the assembly to be placed to the exterior of any of the insulation products listed previously. As the insulation thickness increases, the placement of the building wrap becomes less practical because long cap nails or staples would be required to attach the wrap before the furring can be installed. For these assemblies the use of the insulation as the WRB is usually more practical.

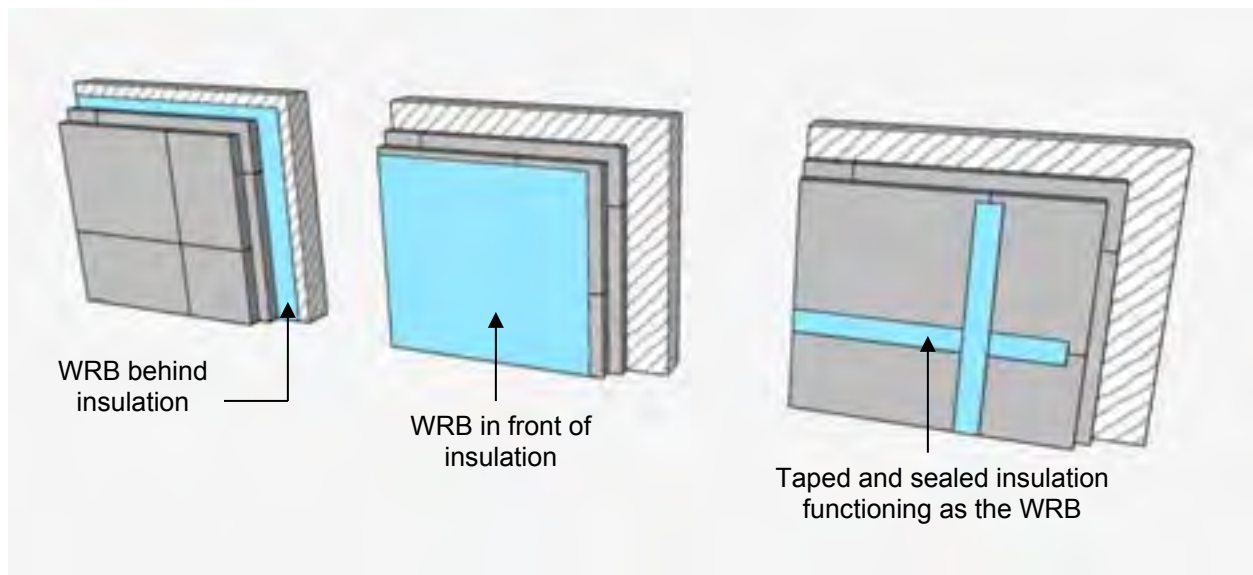

Figure 14. WRB options with exterior insulation

3.3 Air Barrier

As part of an exterior insulation retrofit of a building, some consideration should also be given to improving the airtightness of the building. With exterior retrofits, it is often convenient to integrate an exterior air barrier system as part of the design (see Figure 15). There are significant advantages to this placement of the air barrier, with the greatest being simplified continuity (no disruption at partition walls or floor separations). As such, the details developed also include air barrier continuity issues, though the exact strategy is kept generic. For the purposes of this research, the air barrier has been placed at the interface between the existing structural wall and the exterior insulation. This is the recommended placement of the air barrier for these types of wall assemblies, although BSC recognizes that other possibilities exist.

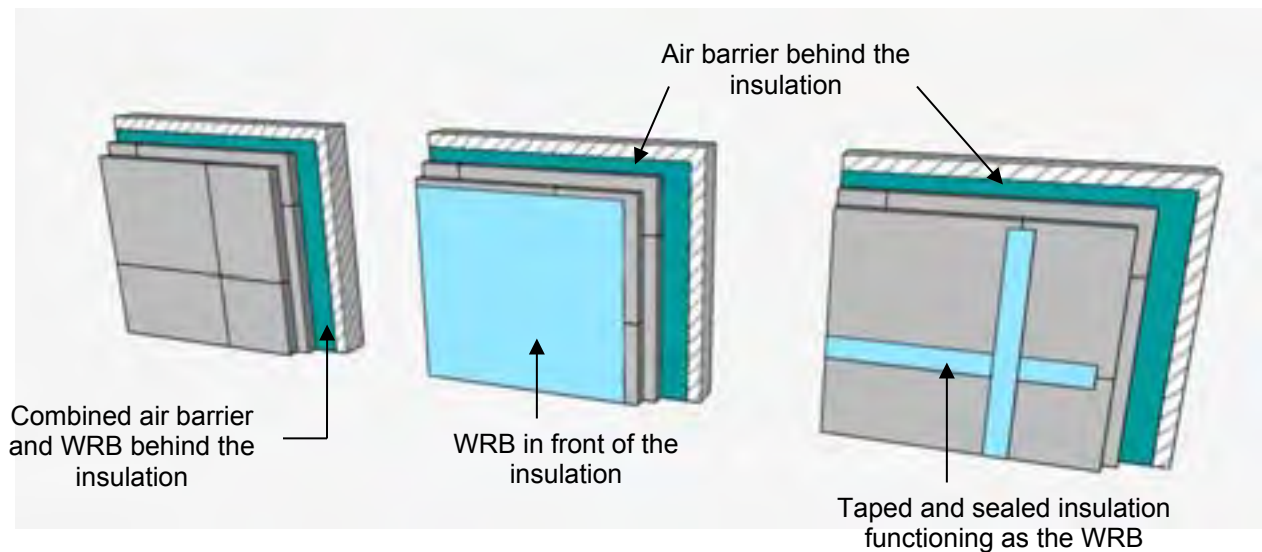

Figure 15. Recommended air barrier location for retrofit assemblies

3.4 Cladding Attachment

The cladding must always be attached by some means back to the primary structure. For thinner insulation thicknesses, it may be possible to directly fasten the cladding through the insulation back to the structure. The practical thickness limit is around 1.5 in. for most wood and fiber cement siding materials and 2 in. for vinyl siding. This limit is based on the availability of fasteners of sufficient length. Most siding guns will have an upper limit of around 3 to 3½ in. for nails.

As a result, it has been a common practice for many years to use furring strips fastened back through the insulation with screws as the cladding attachment mechanism. Using furring strips has other enclosure benefits such as better drainage from behind the cladding and increased drying of the assembly.

Mass masonry walls need to be handled in a slightly different way because of practical limitations of available masonry anchors and anchor installations. Although it is not impossible, using masonry screws to attach the furring back to a masonry structure through thick levels of insulation is often considered to be impractical because most masonry screws require predrilling

of a pilot hole in the masonry. Powder-actuated fasteners are not recommended for use with the insulation in place because they can damage the insulation material. The recommended approach is to attach 2 × 4 wood studs on the flat directly to the masonry wall before installing the insulation (see Figure 16). The 2 × 4 studs then serve as the anchor location for the furring strips.

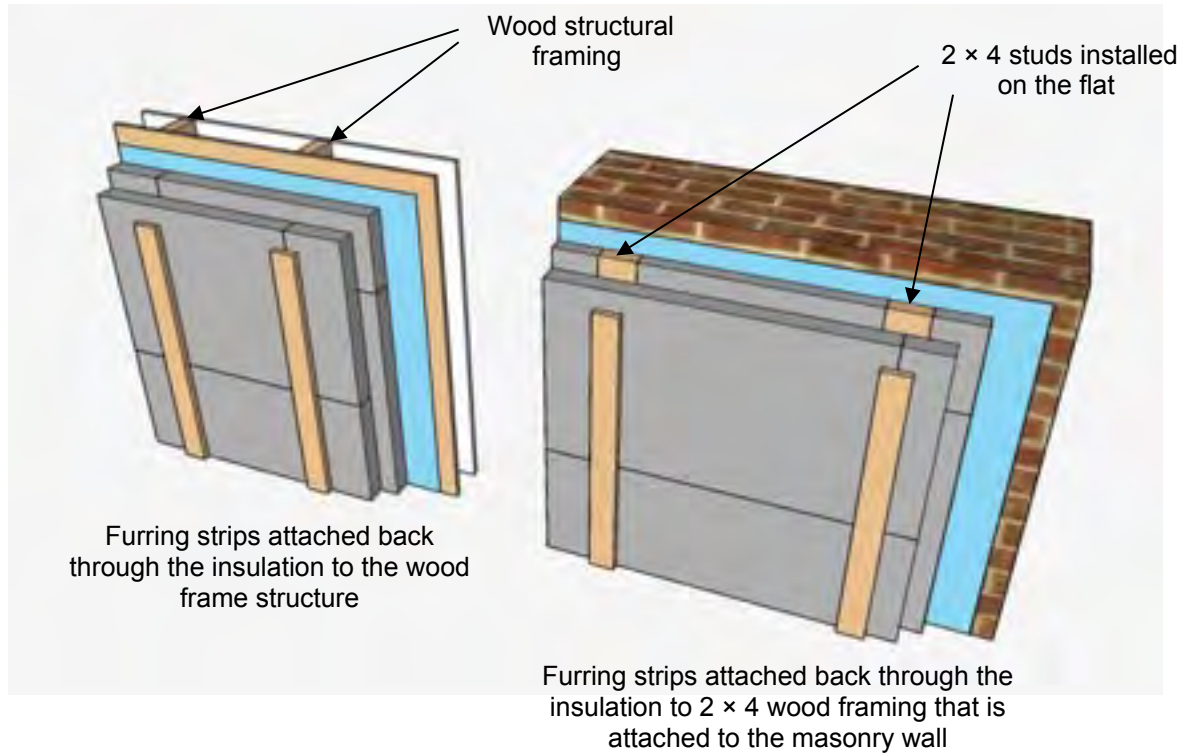

Figure 16. Recommended cladding attachment design

3.5 Window Integration

Integrating the installation of exterior insulating with window assemblies will depend on the window details. The best case scenario is that the window systems are being replaced at the same time that the insulation is being installed on the exterior of the building. With this scenario, it can be fairly simple to integrate the water management details of the windows with the wall assemblies. In some cases, the windows are not intended to be replaced for some time, or not intended to be replaced at all. In either case, integrating the exterior insulation may pose a few more design challenges.

3.5.1 Replacement Window Details

With window replacement, the location of the window in the plane of the wall is often driven by aesthetics. It is common to desire or require maintaining the exterior appearance of older wood sided homes. In this case, the placement of the window will tend to be out in the field of the insulation so that traditional exterior trim dimensions can be maintained. This approach also creates deeper interior sills that many people enjoy. This window placement strategy is colloquially called an “outie” window.

On the other end of the spectrum, windows may also be placed in line with the existing structure, an approach colloquially known as an “innie” window. This placement can help to maintain existing interior trim, but does result in deeper exterior trim returns.

The placement of the window does not need to dictate the placement of the WRB (or the other way around), but there are certain detailing benefits associated with maintaining simple planes of water management. With outie windows, it is easy to integrate the frame with the WRB when the WRB is located at the front face of the insulation. This combination of window location and WRB avoids the need for complicated wrapping and changes in plane of the WRB at a critical enclosure interface. By keeping the details simple, the overall risk of problems developing is greatly reduced. This does not mean that other combinations should not be undertaken, because proper detailing and appropriate material and product use can also reduce risk. In fact, with certain materials such as liquid applied membranes, the risks involved with complicated geometries of the substrate are practically eliminated, allowing for greater design flexibility.

3.5.2 Integration With Existing Windows

With existing windows,⁴ extant conditions can create some integration challenges. Older single-glazed wood windows are still common in many areas. These windows may be desired to be maintained for various reasons, and multiple strategies can be employed to improve their performance. Similarly, in some cases, windows have already been replaced during previous retrofits to the home and are not currently planned for replacement as part of the exterior insulation retrofit.

The integration details for the exterior insulation with existing windows were developed with the intention that the windows might be replaced in the future or that their replacement might be planned as a separate phase to the exterior insulation retrofit. For this reason, the details were developed to allow the windows to be replaced at some point without disturbing the installation of the exterior insulation.

Mass masonry walls pose an additional challenge for maintaining existing windows. Most windows in mass masonry walls are set back in the first wythe of the masonry rough opening. This geometry creates a potential for flanking losses of the thermal insulation. To address this, insulation needs to be returned into the rough opening and connected as closely as possible to the window frame. Where the existing windows have wide jambs and head trim, the space may be readily available. Where the trim is thinner, installing insulation at the returns can be more difficult. Products that are designed to accommodate such concerns are currently on the market. High thermal resistance insulations with a rated R-value of R-10/in. (such as aerogel insulations) would be appropriate to use in instances where the limited space may compromise the desired thermal performance.

A secondary concern with mass masonry wall occurs at the window sills. For existing wood windows, there is inadequate space to allow even high thermal resistance products to be used. In

⁴ Note that without removal of the window system, existing water and air infiltration conditions may lead to durability concerns with the enclosure. Furthermore, when changes to the enclosure are made (such as increasing airtightness and adding thermal insulation), previous conditions that might not have degraded the enclosure’s performance can sometimes become a concern. The individuals integrating these details are responsible for ensuring that no other concerns are preexisting with the building.

these locations, the masonry sill should be removed (see Figure 17). The exposed area can then be grouted to create a smooth surface that is positively sloped to the exterior. Subsequently, the area is covered with a membrane flashing that is integrated into the WRB of the wall assembly. The removal of the sill masonry or stone then provides adequate space to return the insulation to the window frame.

Masonry sill removed to allow for the insulation to return back to the window frame

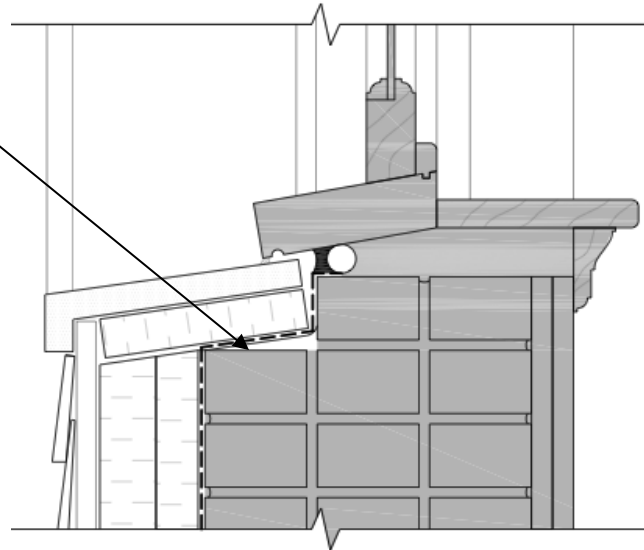

Figure 17. Detail of masonry sill removal to allow for insulation to return to the window frame

3.6 Roof Integration

Several common roof to wall conditions may be encountered (see Figure 18).

- Upper roof to lower wall (all attic types)
- Upper wall to lower roof (vented attic or porch)
- Upper wall to lower roof (unvented attic)

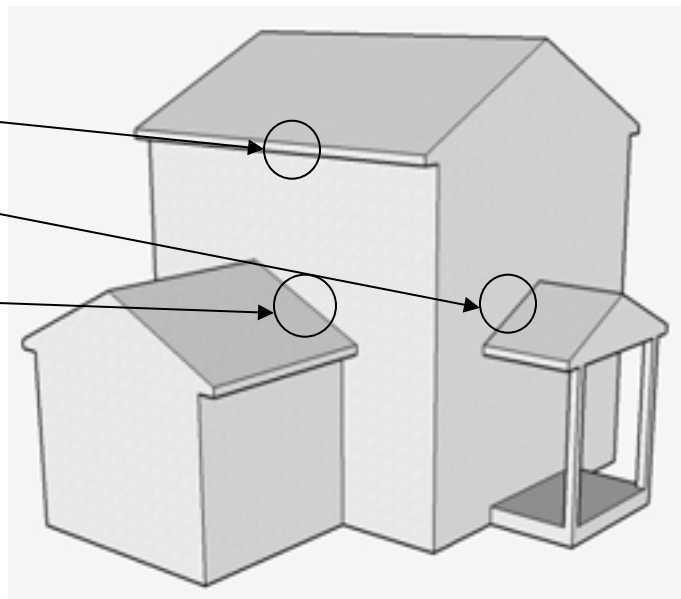

Figure 18. Common roof to wall connections

At the upper roof to lower wall condition, the termination of the exterior insulation does not change significantly whether the attic is vented or unvented. The differences would mostly be associated with the attic design and not the wall design.

Where an upper wall intersects a lower roof, the termination details are critical and will depend greatly on the design of the attic below. For vented attics or porch roofs, the intent is to maintain the continuity of the insulation past the roofline because the wall above and the continuation of the wall below the roof are both considered exterior wall assemblies.

From an airtightness perspective, what is known as a “chain-saw” retrofit is the most effective way to address this detail. In this case, the roof or porch are physically cut from the building, allowing the exterior insulation and air barrier (if part of the design) to run continuous past the roofline. The roof or porch structure is then reattached or independently supported and flashed back into the water management strategy of the building. Alternately, the roof structure may be left in place and the insulation installed from above and below the existing roofline. This creates greater risk of air leakage and requires more careful detailing of the air barrier system.

For unvented attics, the location of the insulation and the air barrier will also affect the details. For these roof to wall connections a chain-saw retrofit will not provide any additional benefit because the plane of the insulation and airtightness follows the roofline.

In all cases, flashing of the roof to wall interface is critical for maintaining the continuity of the water management system. The location of the roof flashing will depend on the selected location of the WRB of the wall assembly (Figure 19).



Figure 19. Different drainage plane placement for exterior insulation retrofits

If the WRB is designed to be behind the exterior insulation, the step flashing and shingles must extend back to the plane of the exterior wood sheathing or masonry wall. A consideration for the detailing of this interface is the future need to replace the roof of the building. The roof covering will undoubtedly have a shorter service life than the wall cladding. For this reason, a way to access the roof to wall interface behind the exterior insulation should be provided so that future work can be completed without disrupting the primary siding installation. A minimum 8-in. band

of siding and insulation is recommended for installation at the roof to wall interface. This band creates a removable termination to allow for future access to the flashing at the roof to wall interface (sequence shown in Figure 20). The band has a secondary benefit as an easy detail for installing a kick-out flashing if the end of the roof terminates in the field of the wall.

Step 1:

Install self-adhered membrane flashing at the roof to wall interface.

Install kick-out flashing at the edge of the roof.

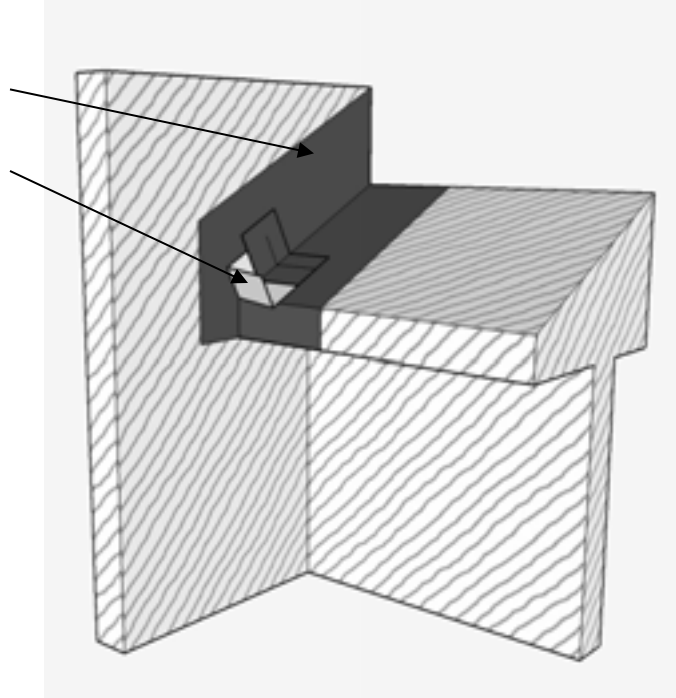

Step 2:

Install the roof covering and step flashing following standard roofing practice.

Shingle lap the top edge of the step flashing with the wall WRB or strip in additional membrane flashing.

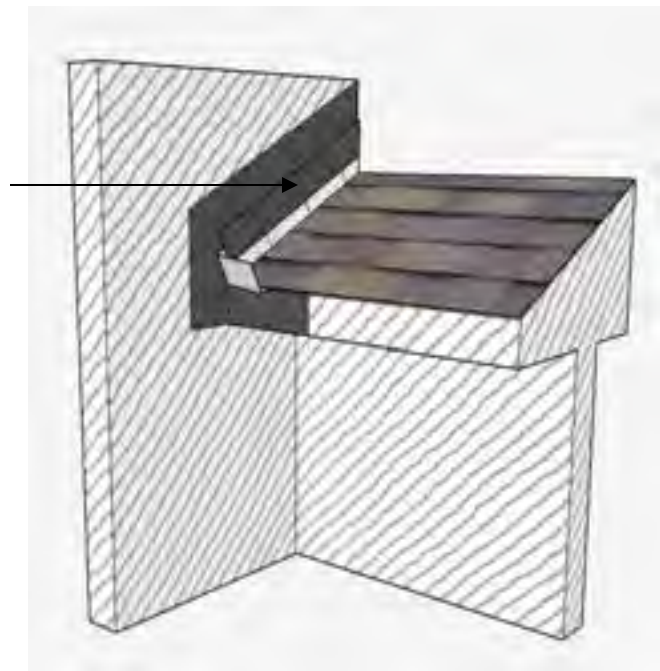

Step 3:

Install insulation over the wall area.

Construct an 8-in. gap along the roofline.

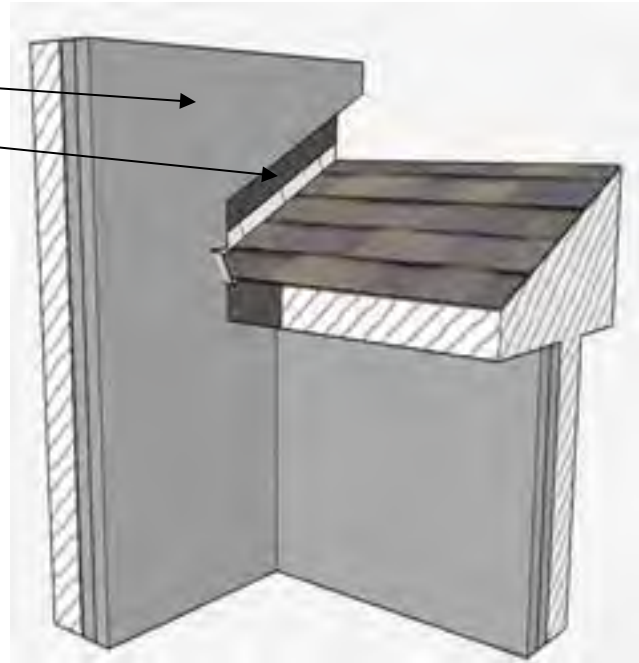

Step 4:

Fill the 8-in. gap with a strip of insulation that can be removed later to allow for access to the step flashing during replacement of the lower roof.

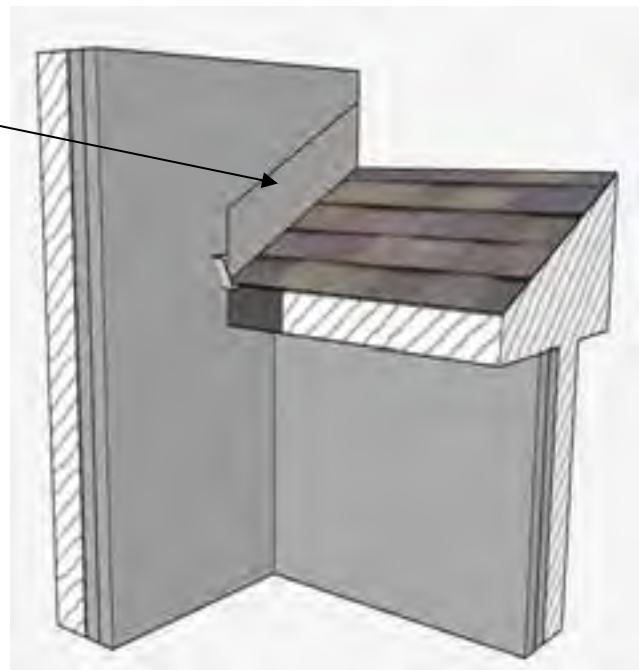

Figure 20. Roof to wall interface with WRB behind the insulation

If the WRB is designed to be placed at the face of the exterior insulation, more standard roofing details can be used. BSC still recommends providing the trim band for access to the roof to wall interface, although it is no longer as critical. Attaching the step flashing can be accomplished using longer nails that can penetrate through the insulation back to the wall sheathing. As the insulation thicknesses increase, this becomes less practical. As an alternative, a strip of OSB or

plywood can be added to the front of the insulation and covered with a self-adhered membrane flashing. This plywood or OSB strip would then serve as the nail base for the step flashing, resulting in a more conventional installation. The construction sequence is likely to be the single greatest challenge that a builder will face with this approach. Roof coverings are installed as soon as possible to protect the building from rain infiltration. The concern is that the detail requires the wall insulation to be in place before the roof is installed. This has created problems on several retrofit projects. A solution to this is to install a strip of wall insulation (that is temporarily flashed back to the wall sheathing) at the roof to wall connection to allow the roof to be installed independently of the wall system (sequence shown in Figure 21). This requires preplanning and coordination during construction.

Step 1:

Install an air barrier transition membrane and insulation at the roof to wall interface.

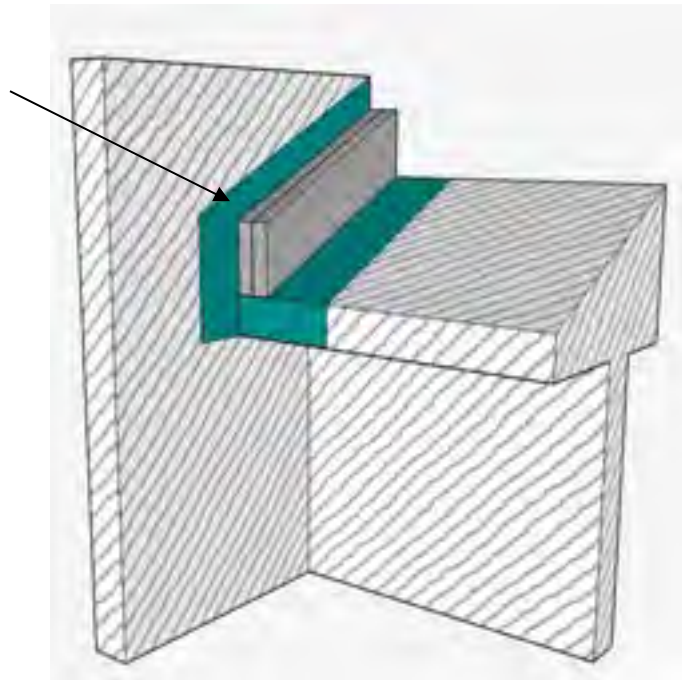

Step 2:

Install a self-adhered membrane that extends from the roof deck, up and over the insulation, and connects to the wall sheathing (this step temporarily waterproofs the roof to wall connection during the construction process).

Install kick-out flashing at the roof edge.

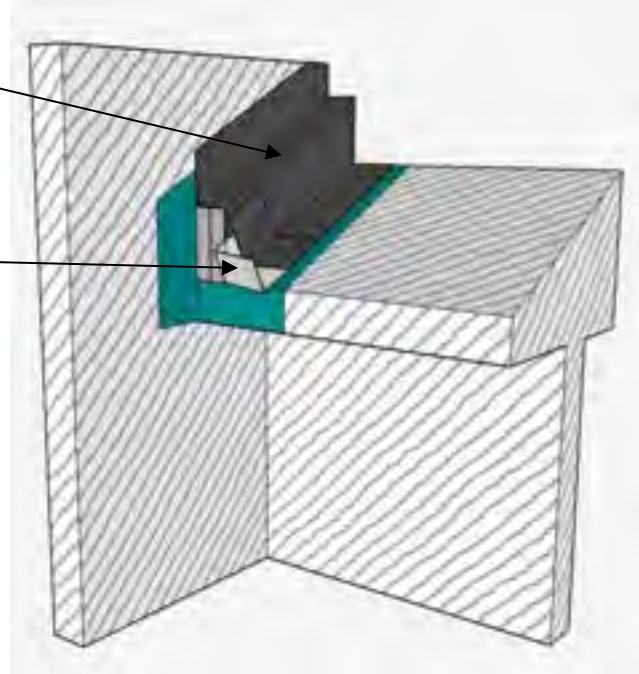

Step 3:

Install the roof covering and step flashing following standard roofing practice.

Strip in the top edge of the step flashing with additional membrane flashing.

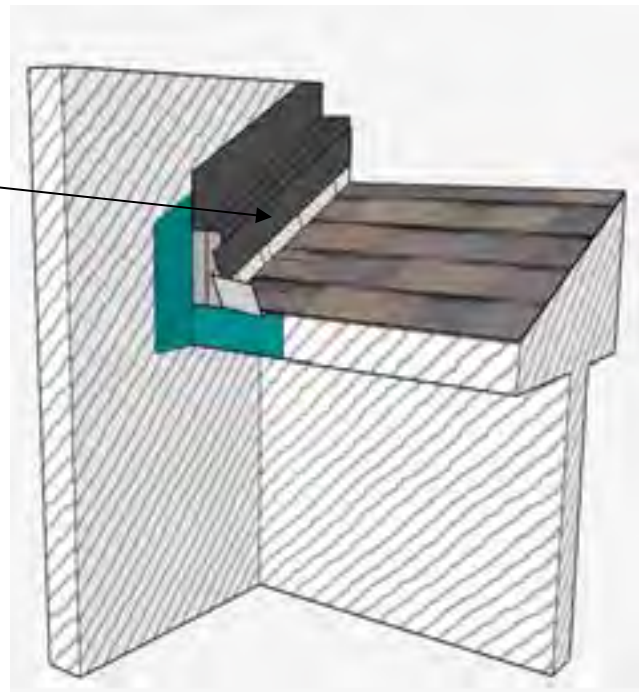

Step 4:

Install insulation over the wall area.

Shingle lap the joint at the curb with the wall WRB or strip in additional membrane flashing.

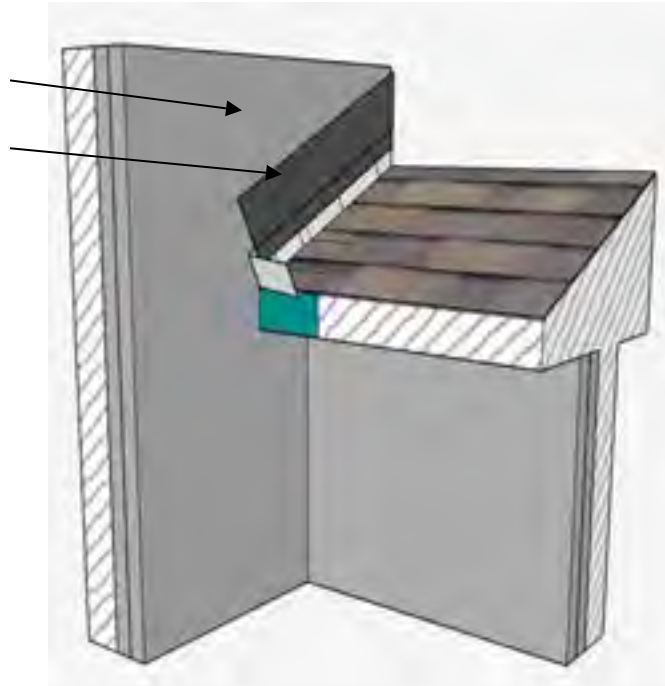

Figure 21. Roof to wall interface with WRB at the face of the insulation

3.7 Balcony Integration

Balconies (or decks where the drainage is on top of the structure) are most similar to upper wall to lower roof interfaces. Again, separating the balcony from the structure to allow the insulation and the air barrier to run continuous past the edge of the balcony will maintain the best continuity of the thermal insulation and the air barrier. In many cases, however, the balconies are part of the building structure, either through cantilevered wood framing members or cast concrete as is the case with many masonry buildings. In these situations, cutting and removing the balcony may not be feasible.

Wood framed balconies are more easily handled than concrete balconies. If the balcony cannot be separated from the building, insulating above and below can often sustain suitable continuity. Because of the high conductivity of concrete, the most challenging situation is likely to be the cast concrete balcony.

3.8 Deck Integration

Similar to upper wall to lower roof interfaces with vented attics and porch roofs, the best approach from a thermal and air barrier continuity perspective is to use a chain-saw retrofit approach with framed decks. In this case, the deck is physically cut from the building, allowing the exterior insulation and air barrier (if part of the design) to run continuous past the deck line. The deck structure is then reattached or independently supported and flashed back into the water management strategy of the building. As an alternative, the deck structure may be left in place and the insulation installed from above and below the existing roofline. This creates greater risk of air leakage and requires more careful detailing of the air barrier system.

4 Conclusions

In this research project, BSC developed baseline engineering analysis to support the installation of thick layers of exterior insulation on existing masonry and frame walls. Water management details necessary to integrate windows, doors, decks, balconies, and roofs were also created to serve as guidance for integrating exterior insulation strategies with other enclosure elements. The details give consideration to complete retrofit as well as phased retrofit approaches. These connection details allow for future integration with other high performance enclosure system elements.

BSC determined that acceptable deflection instead of ultimate capacity of the systems governed the design. For lap sidings and panel claddings with joints (metal, vinyl, wood, and fiber cement), movement is aesthetic in nature and not a health and safety issue. The acceptable amount of deflection will be a function of acceptable aesthetics for the cladding system chosen. For most lap siding or panel cladding systems, variations up to 1/16 in. or even 1/8 in. may be acceptable because the material and installation tolerances are easily greater than the potential gap development. BSC recommends, therefore, that the deflection be limited to 1/16 in. in service unless it is demonstrated that larger deflections can be tolerated.

For brittle claddings (such as stucco and cultured stone), movement could lead to cracking and potentially spalling of the material. For these systems BSC recommends that the service deflection limit be set to prevent deflection that may damage the cladding or impair its function. A limit of 1/64 in. is proposed after initial deflection for brittle claddings.

Most common residential cladding systems (metal, vinyl, wood, and fiber cement) are lightweight enough (<5 psf) that attachment to furring over any thickness of insulation is not problematic. For these cladding systems, the predicted deflection based on a reasonable horizontal spacing (16- to 24-in. o.c.) and vertical fastener spacing (up to 24-in. o.c.), is so slight (1/200 in.) and creep effects are so minimal that the predicted deflection does not approach the proposed 1/16-in. maximum in-service deflection limit.

For heavier cladding systems (>10 psf) initial deflection is within the proposed deflection limit. There is, however, inadequate information about potential thermal and moisture expansion and contraction movements, as well as creep effects of certain insulation materials in exposed environments. This lack of information makes predicting long-term in-service deflections difficult. Additional research into the long-term deflection movement of heavier claddings in exposed environments is needed.

Integrating exterior insulation into the water management strategy of the building takes careful detailing at interfaces with other enclosure elements.

For the most part, placing the WRB to the exterior of the insulation has been easiest because the details are largely similar to standard construction practices. Concern is often raised about a way to support elements that were once positioned in the structural frame wall, which are now “pushed” outward into the plane of the exterior insulation (e.g., windows and step flashings).

Conversely, placing the WRB inboard of the exterior insulation has been more difficult for contractors to adopt because of some significant departures from standard construction details

and common construction sequences. These concerns increased when these techniques were applied to a building retrofit. This WRB placement, however, has benefits. The WRB is placed in a more protected location (increasing durability), and the window can be located in the plane of the existing framing.

As part of this work, BSC developed details to serve as guidance on effectively maintaining the continuity of the water management strategy. These details are presented in Appendix A of this report.

References

- AF&PA (2005). *National Design Specification (NDS) for Wood Construction*. American Forest & Paper Association, Washington, DC. www.awc.org/standards/nds.html
- AF&PA (1999). *General Dowel Equations for Calculating Lateral Connection Values: Technical Report 12*. American Forest & Paper Association, Washington, D.C. www.awc.org/standards/nds.html
- BSC (2010). *Building America Annual Report: 8.1 Westford Habitat for Humanity Prototype House, Westford, MA*. Somerville, MA: BSC.
- BSC (2009a). *Building America Annual Report: D.2 HFH of Greater Lowell, Farmhouse Renovation, Bedford, MA*. Somerville, MA: BSC.
- BSC (2009b). *Building America Annual Report: D.4 "Lot 26" – Meadows at Cumberland Ridge, Dowingtown, PA*. Somerville, MA: BSC.
- Crandell, J.H. (2010). *Task 3 Report: Develop a Prescriptive Table for Attaching Cladding to Framing over Continuous Insulation and Develop a Code Proposal*. SFA and NYSERDA. New York City, NY
- Hutcheon, N.B. (1964). "Principles Applied to an Insulated Masonry Wall." *NRC-IRC (National Research Council of Canada-Institute for Research in Construction) Canadian Building Digest (CBD-50)*. Ottawa, ON: National Research Council of Canada.
- Joyce, D. (November 2009). "Retrofitting Exterior Insulation." *Journal of Light Construction*., Accessed August 10, 2011 from <http://www.jlconline.com/building-envelope/retrofitting-exterior-insulation.aspx>
- Lstiburek, J.W. (2007). "Building Sciences: The Perfect Wall." *ASHRAE Journal* (50:May); pp. 74–78.
- Lstiburek, J.W. (2009). "Building Sciences: Building in Extreme Cold." *ASHRAE Journal* (51:February); pp. 56–59.
- Lstiburek, J.W. (2010). "Building Sciences: Mind the Gap, Eh!" *ASHRAE Journal* (52:January); pp. 57–63.
- Pettit, B. (2009). "Deep Energy Retrofit of a Sears Roebuck House: A Home for the Next 100 Years." *High Performing Buildings* (2:Spring).
- Reed Construction Data (2011). *RSMeans CostWorks 2011, 15th Annual Edition*. Norwell, MA: Reed Construction Data.
- Straube, J.F.; Smegal, J. (2009). *Building America Special Research Project – High-R Walls Case Study Analysis*. BA-0903. Accessed October 21, 2013. <http://www.buildingscience.com/documents/bareports/ba-0903-building-america-special-research-project-high-r-walls/view>
- Ueno, K. (2010). "Residential Exterior Wall Superinsulation Retrofit Details and Analysis." *Performance of the Exterior Envelopes of Whole Buildings XI*. Atlanta, GA: ASHRAE.
- U.S. Department of Energy, Energy Information Administration (2008). *Annual Energy Review 2007*. DOE/EIA-0384(2007). Washington, DC: Energy Information Administration.

Appendix A: Water Management Details

<p>Exterior Insulation over Wood Frame Wall Drainage Plane at Face of Insulation</p> <p>W1-Ra Vented Attic to Wood Frame Wall - A W1-Rb Unvented Attic to Wood Frame Wall - B W1-Rc Unvented Attic to Wood Frame Wall - C W1-Rd Unvented Attic to Wood Frame Wall "Chain Saw" - D</p> <p>W1-RWa Vented Attic to Wood Frame Wall - A W1-RWb Unvented Attic to Wood Frame Wall - B W1-RWc Unvented Attic to Wood Frame Wall - C W1-RWd Vented Attic to Wood Frame Wall "Chain Saw" - D</p> <p>W1-Ba Balcony Over Unconditioned Space to Wood Frame Wall - A W1-Bb Balcony Over Conditioned Space to Wood Frame Wall - B W1-Bc Balcony Over Unconditioned Space to Wood Frame Wall "Chain Saw" - C</p> <p>W1-Da Deck to Wood Frame Wall - A W1-Db Deck to Wood Frame Wall "Chain Saw" - B W1-Dc Deck to Wood Frame Wall - C W1-Dd Deck to Wood Frame Wall "Chain Saw" - D</p> <p>W1-WH0a Window Head at Wood Frame Wall - "Outie" W1-WS0a Window Sill at Wood Frame Wall - "Outie" W1-WJ0a Window Jamb at Wood Frame Wall - "Outie"</p> <p>W1-WH0b Window Head at Wood Frame Wall - "Innie" W1-WS0b Window Sill at Wood Frame Wall - "Innie" W1-WJ0b Window Jamb at Wood Frame Wall - "Innie"</p> <p>Exterior Insulation over Wood Frame Wall Drainage Plane at Face of Wood Frame</p> <p>W2-Ra Vented Attic to Wood Frame Wall - A W2-Rb Unvented Attic to Wood Frame Wall - B W2-Rc Unvented Attic to Wood Frame Wall - C</p> <p>W2-RWa Vented Attic to Wood Frame Wall - A W2-RWb Unvented Attic to Wood Frame Wall - B W2-RWc Unvented Attic to Wood Frame Wall - C</p> <p>W2-Ba Balcony Over Unconditioned Space to Wood Frame Wall - A W2-Bb Balcony Over Conditioned Space to Wood Frame Wall - B</p> <p>W2-Da Deck to Wood Frame Wall - A W2-Db Deck to Wood Frame Wall - B</p> <p>W2-WH Window Head at Wood Frame Wall W2-WS Window Sill at Wood Frame Wall W2-WJ Window Jamb at Wood Frame Wall</p> <p>W2-WH0 Window Head at Wood Frame Wall - "Innie" W2-WS0 Window Sill at Wood Frame Wall - "Innie" W2-WJ0 Window Jamb at Wood Frame Wall - "Innie"</p>	<p>Exterior Insulation over Mass Masonry Wall Drainage Plane at Face of Insulation</p> <p>M1-Ra Vented Attic to Masonry Wall - A M1-Rb Unvented Attic to Masonry Wall - B M1-Rc Unvented Attic to Masonry Wall - C M1-Rd Unvented Attic to Masonry Wall "Chain Saw" - D</p> <p>M1-RWa Vented Attic to Masonry Wall - A M1-RWb Unvented Attic to Masonry Wall - B M1-RWc Unvented Attic to Masonry Wall - C M1-RWd Vented Attic to Masonry Wall "Chain Saw" - D</p> <p>M1-Ba Balcony Over Unconditioned Space to Masonry Wall - A M1-Bb Balcony Over Conditioned Space to Masonry Wall - B M1-Bc Balcony Over Unconditioned Space to Masonry Wall "Chain Saw" - C</p> <p>M1-Da Deck to Masonry Wall - A M1-Db Deck to Masonry Wall "Chain Saw" - B M1-Dc Deck to Masonry Wall - C M1-Dd Deck to Masonry Wall "Chain Saw" - D</p> <p>Exterior Insulation over Mass Masonry Wall Drainage Plane at Face of Masonry</p> <p>M2-Ra Vented Attic to Masonry Wall - A M2-Rb Unvented Attic to Masonry Wall - B M2-Rc Unvented Attic to Masonry Wall - C</p> <p>M2-RWa Vented Attic to Masonry Wall - A M2-RWb Unvented Attic to Masonry Wall - B M2-RWc Unvented Attic to Masonry Wall - C</p> <p>M2-Ba Balcony Over Unconditioned Space to Masonry Wall - A M2-Bb Balcony Over Conditioned Space to Masonry Wall - B</p> <p>M2-Da Deck to Masonry Wall - A M2-Db Deck to Masonry Wall - B</p> <p>M2-WH Window Head at Masonry Wall M2-WS Window Sill at Masonry Wall M2-WJ Window Jamb at Masonry Wall</p>	
	<p>Exterior Insulation over Wood Frame Wall and Mass Masonry Wall Detail List</p> <p>Date: 2012-03-05</p>	<p>Sheet Title: Index</p>
<p>COPYRIGHT © 2011 BUILDING SCIENCE CORPORATION</p>		

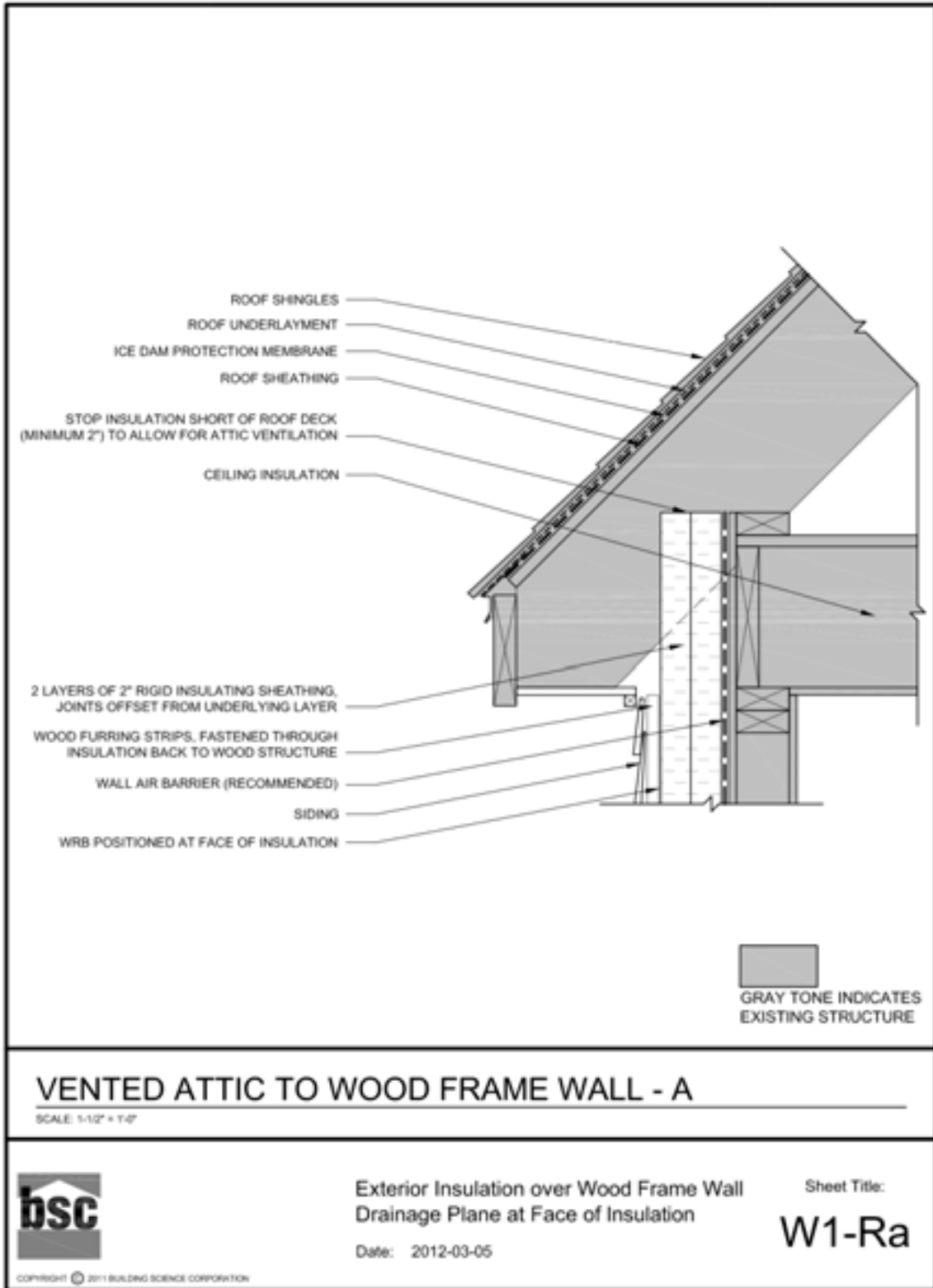

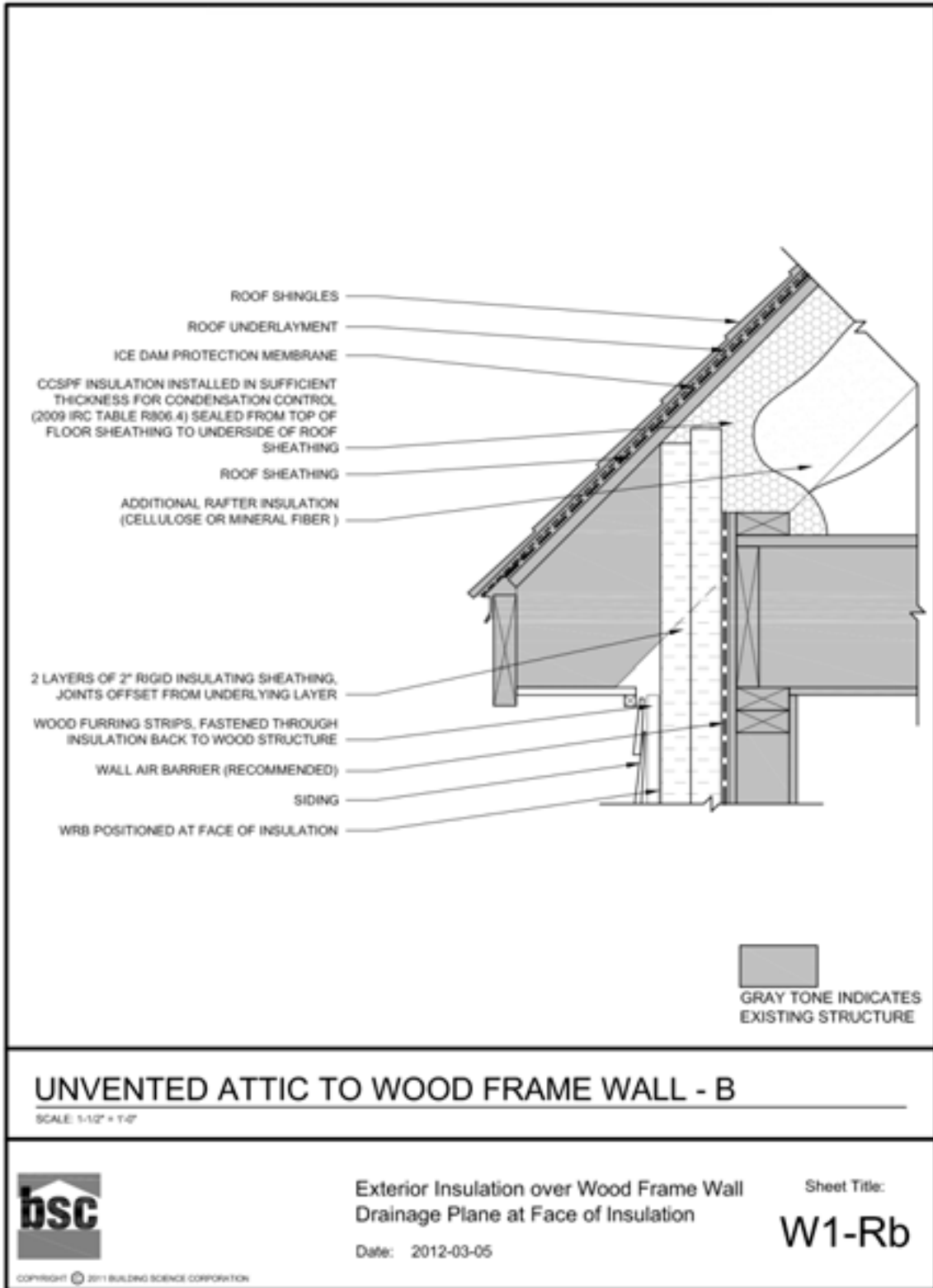

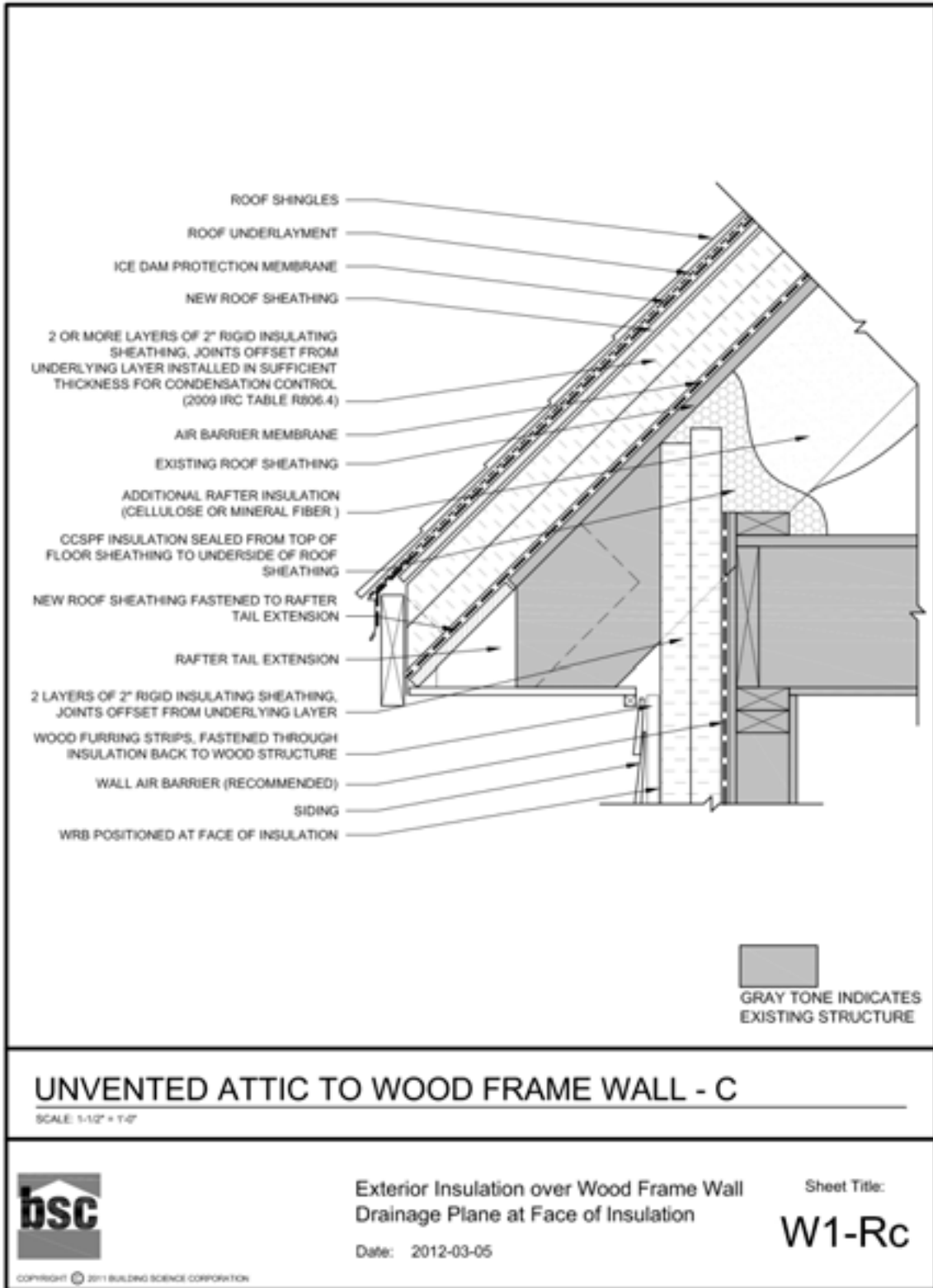

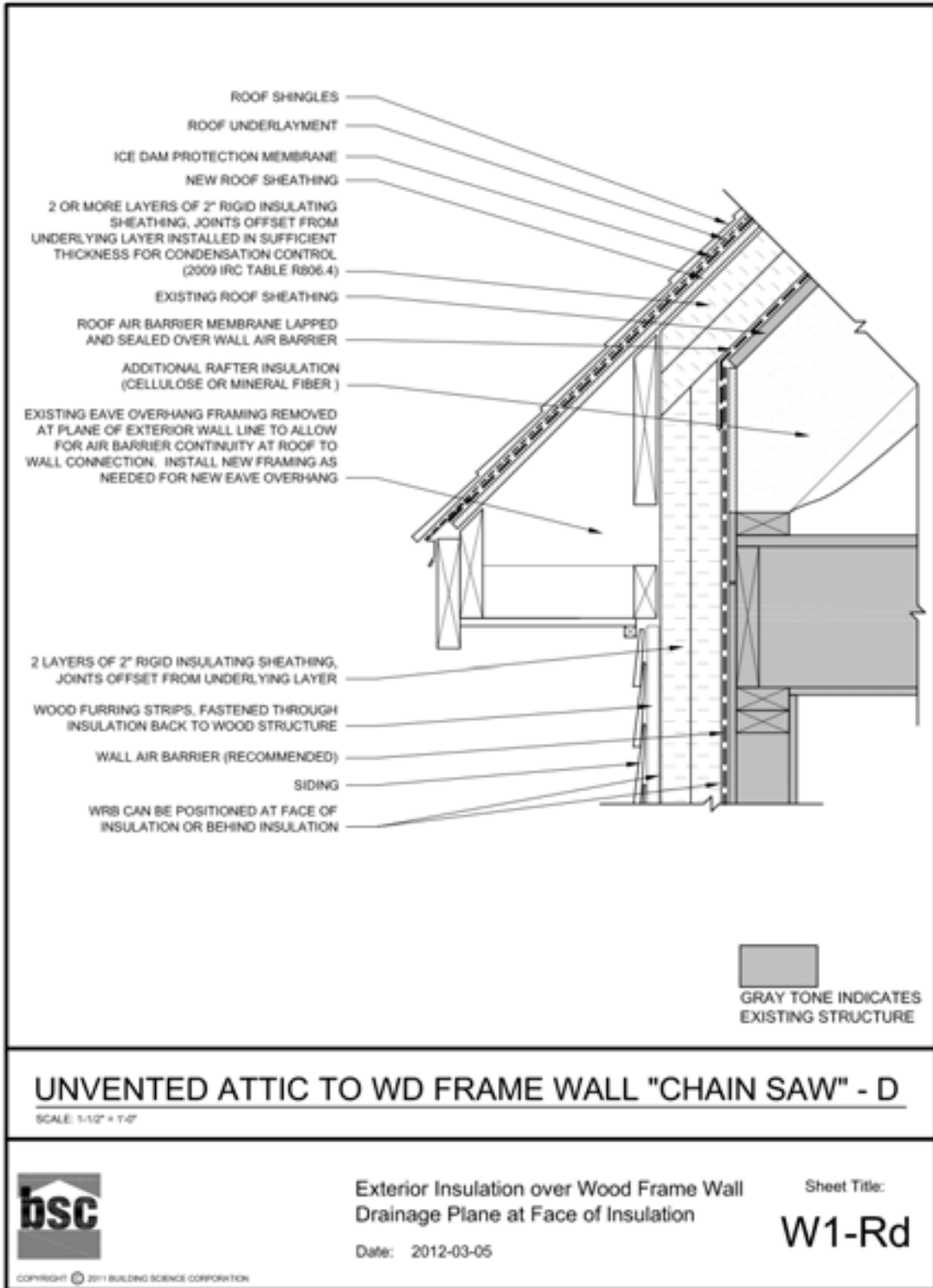

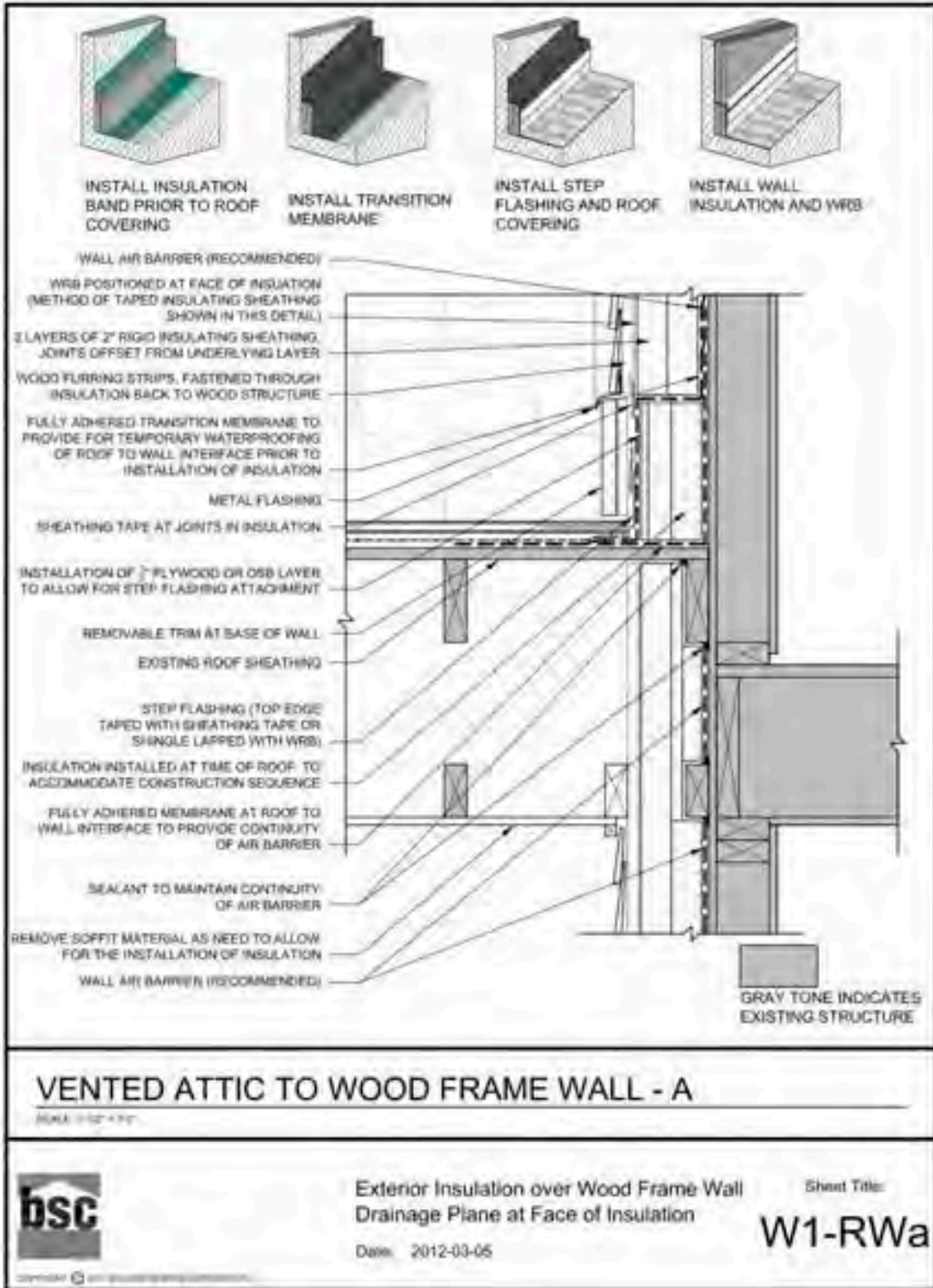

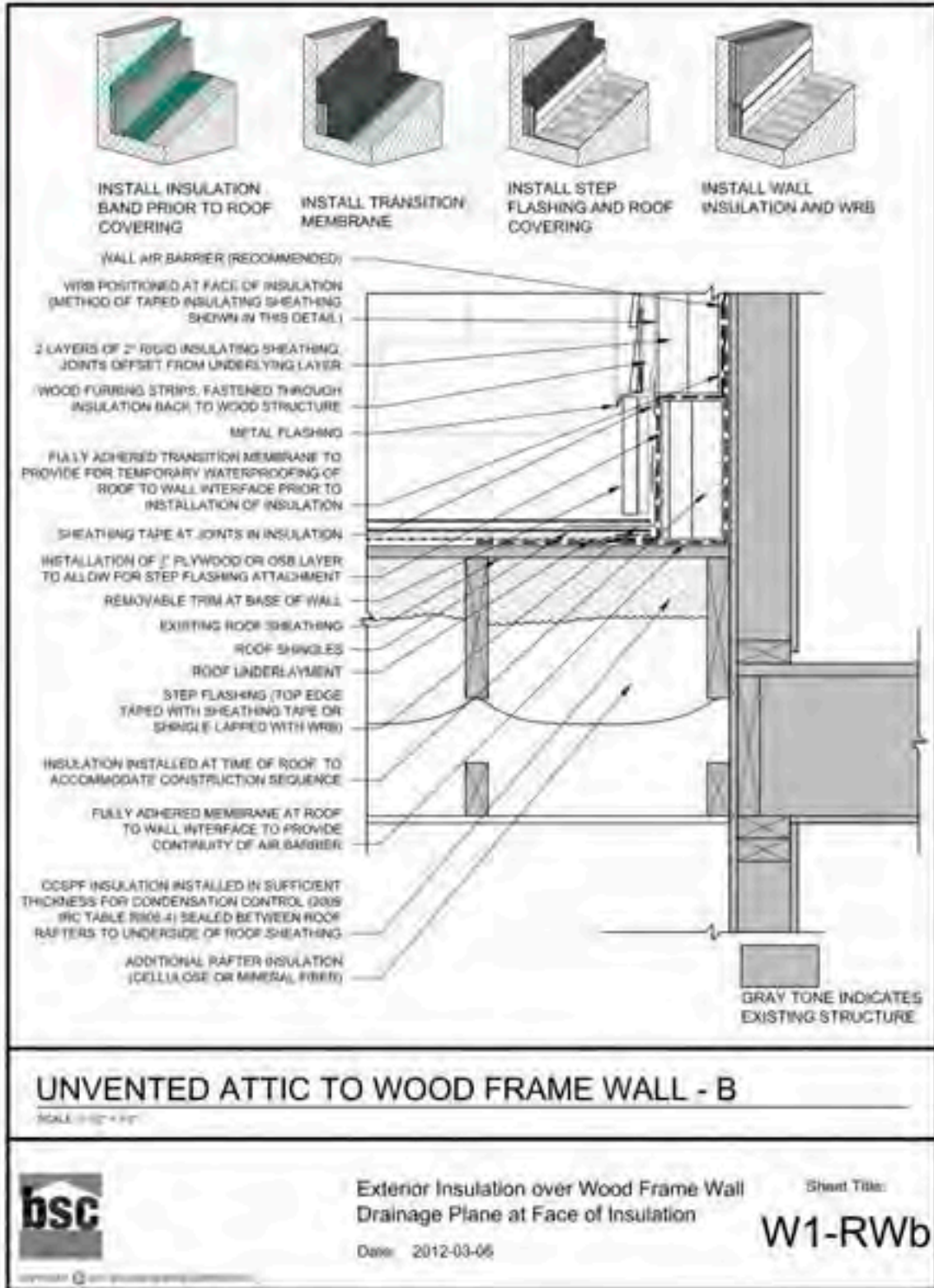

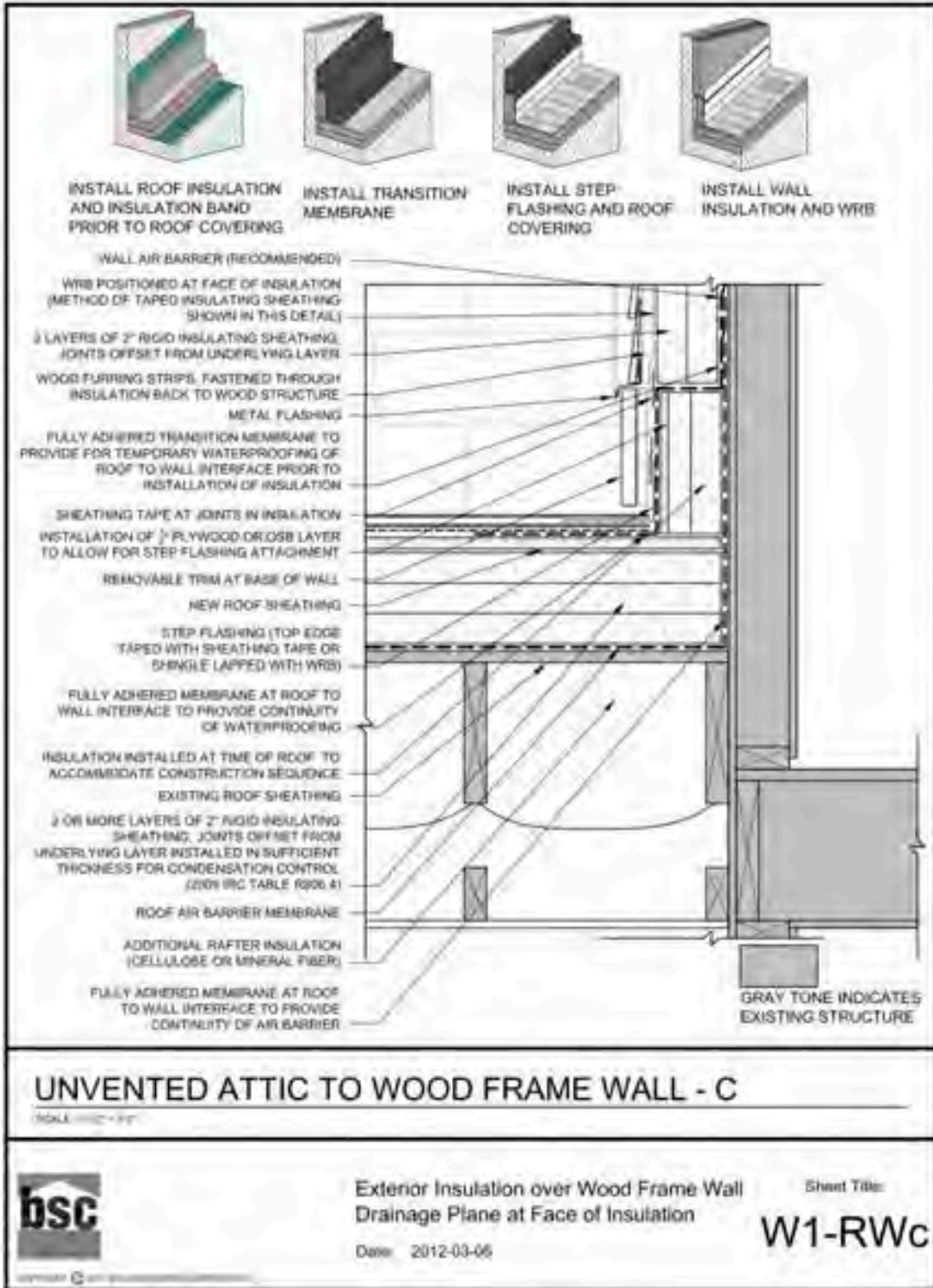

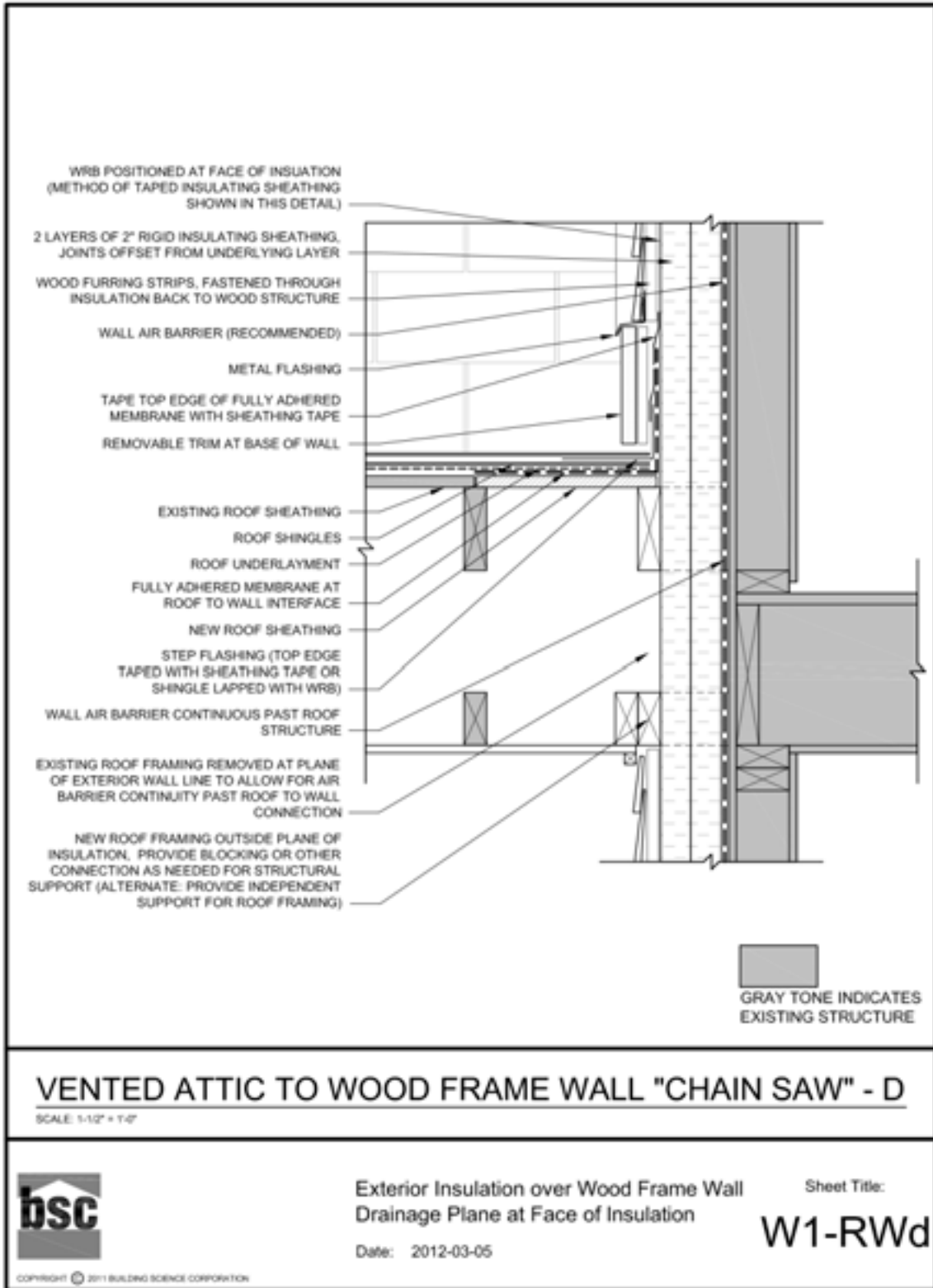

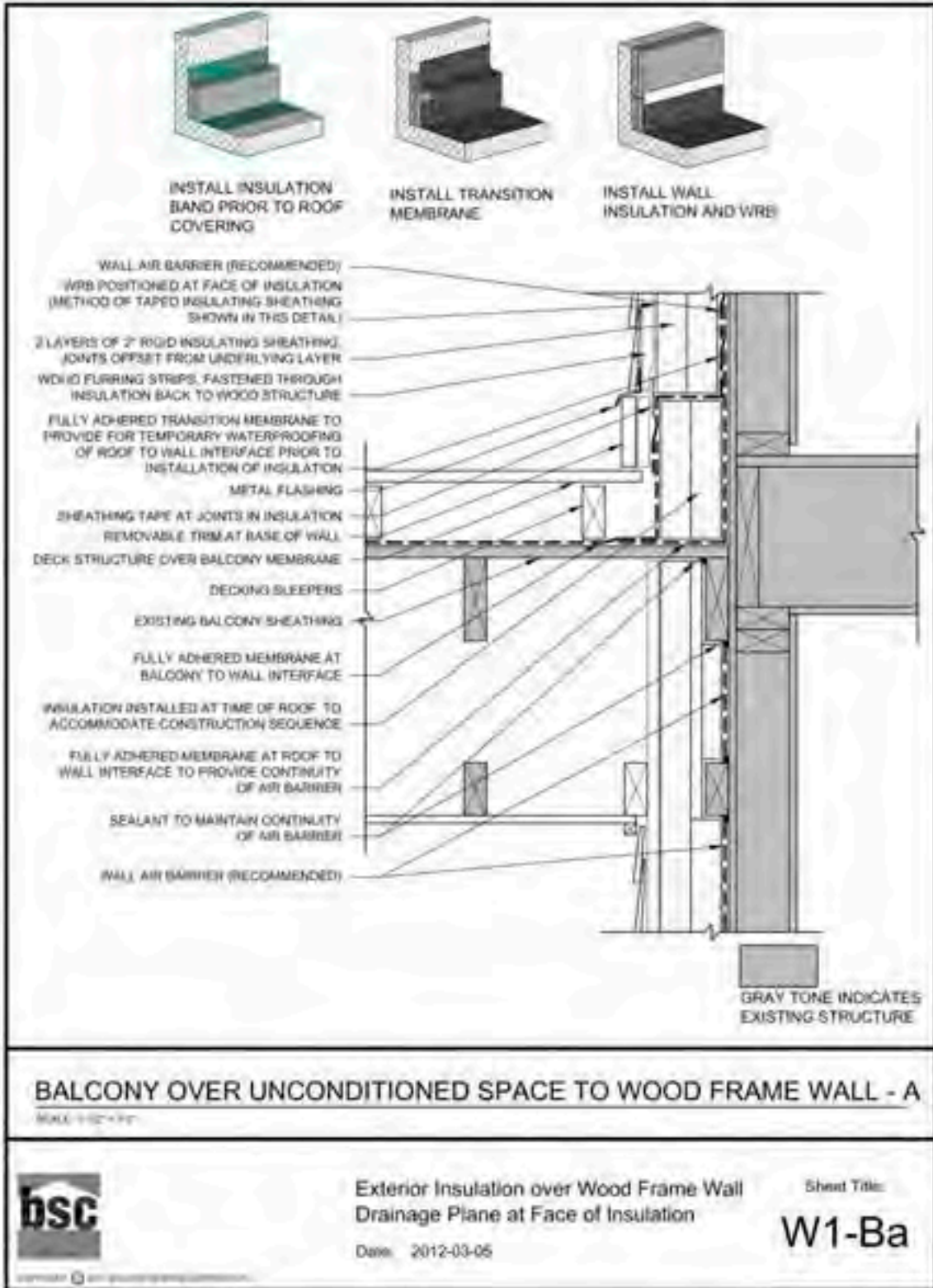

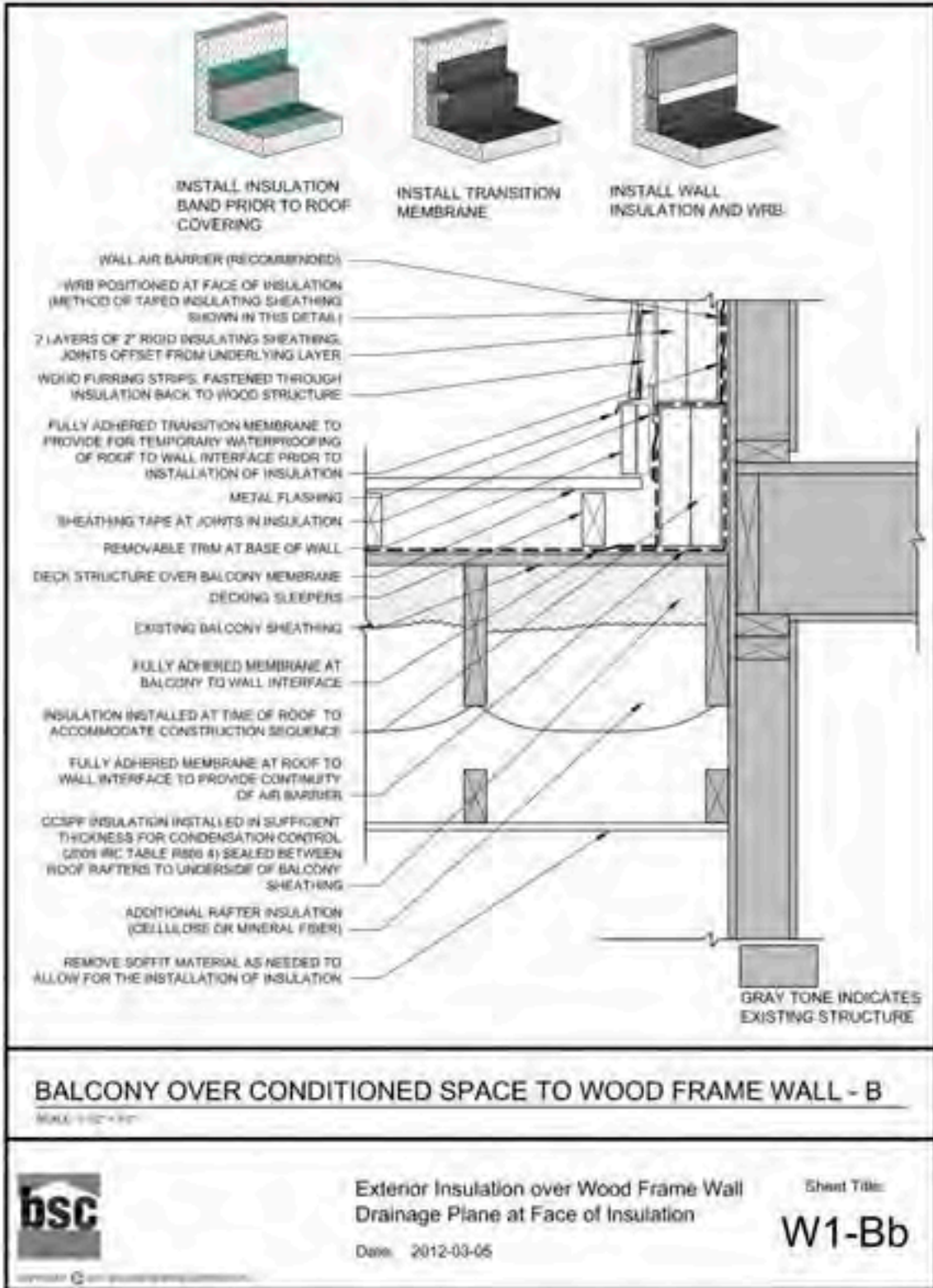

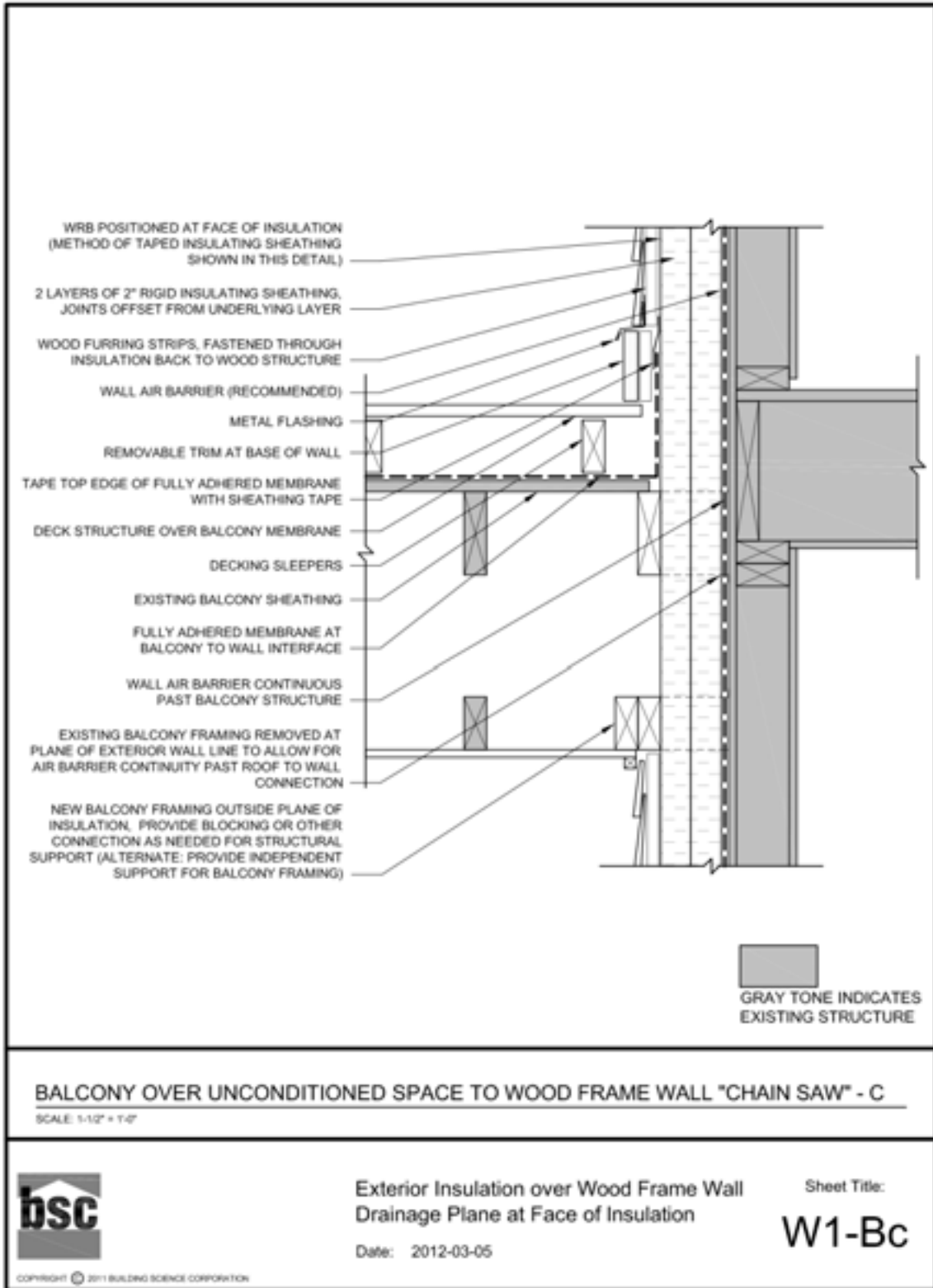

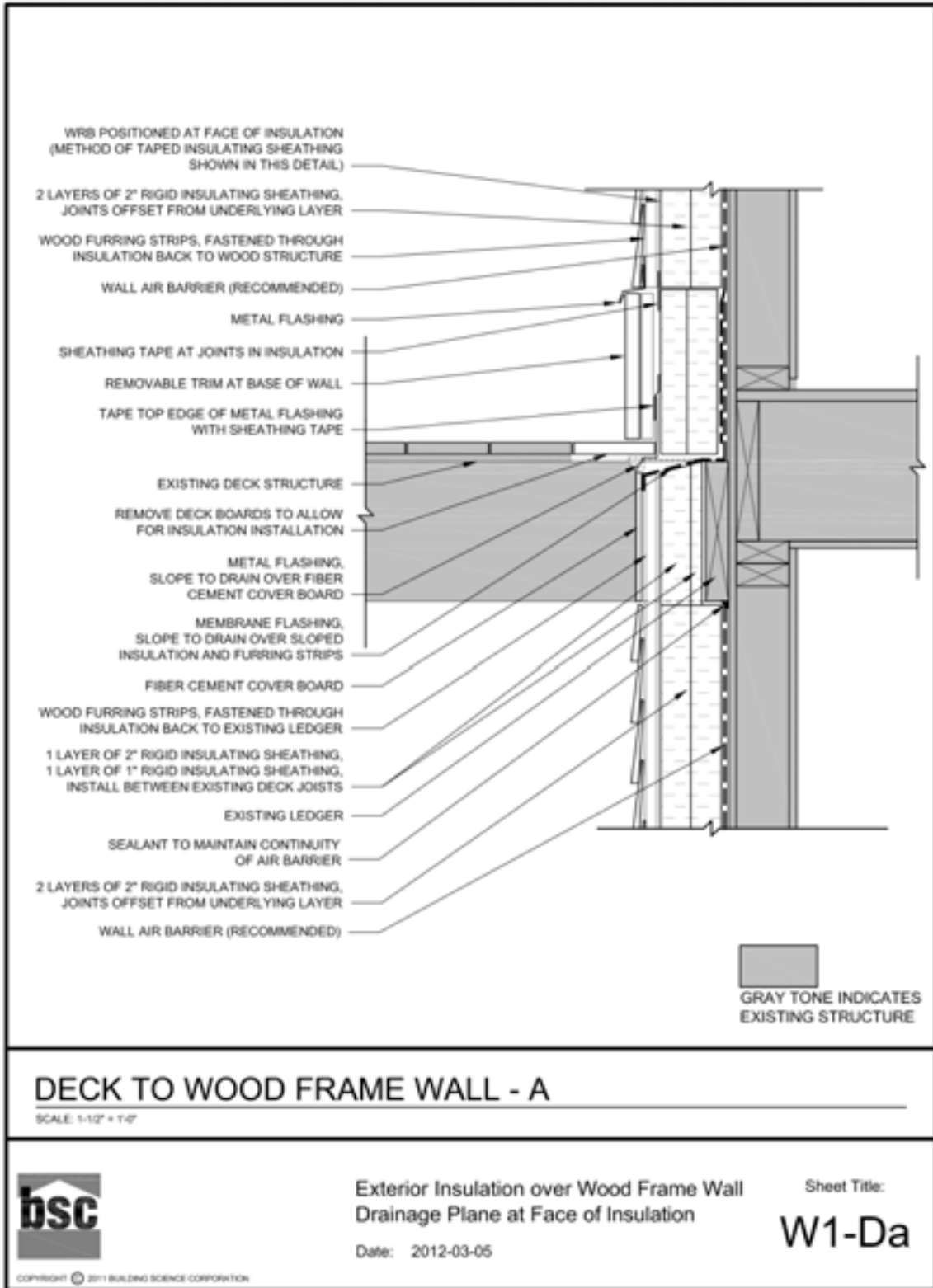

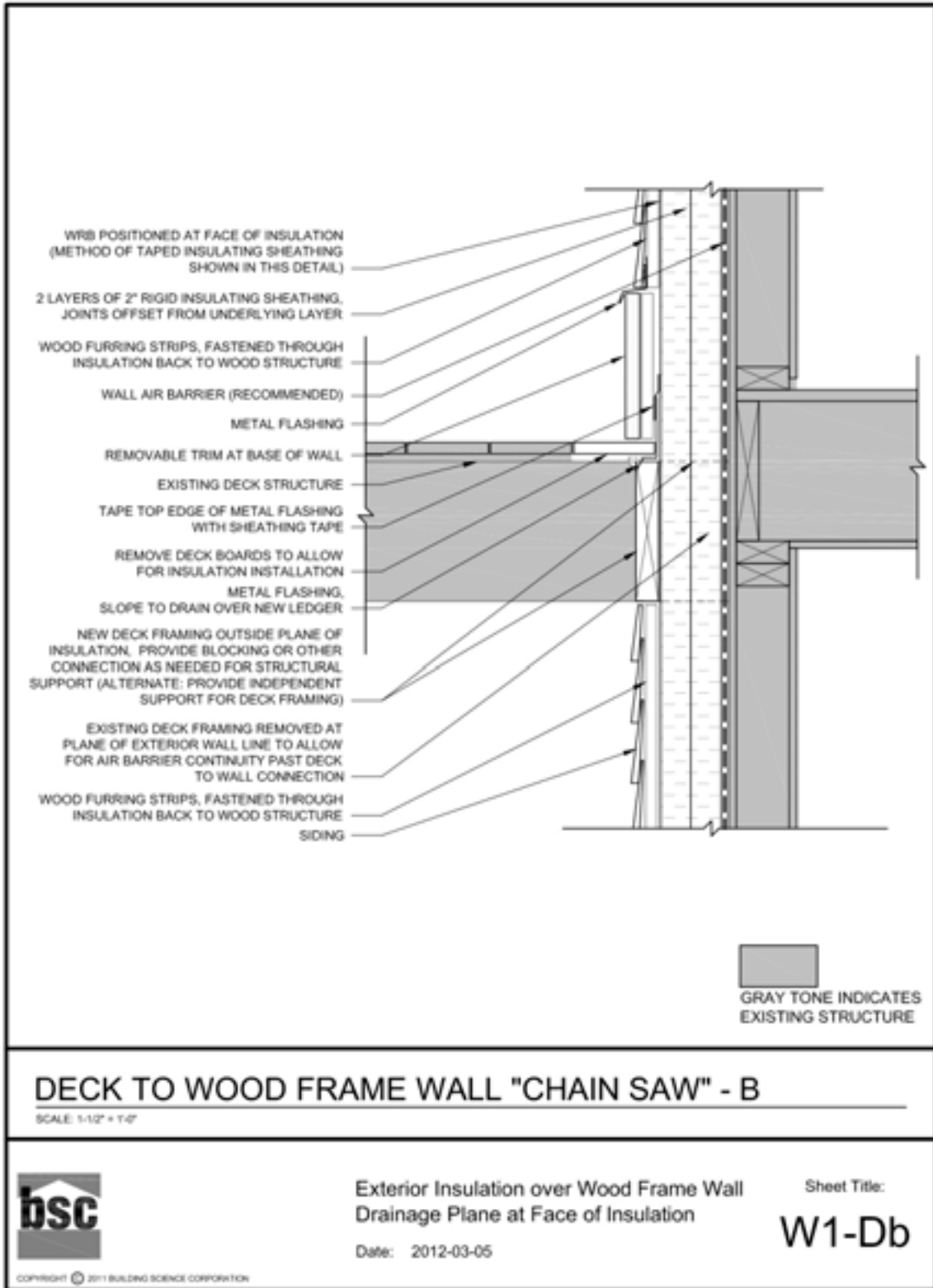

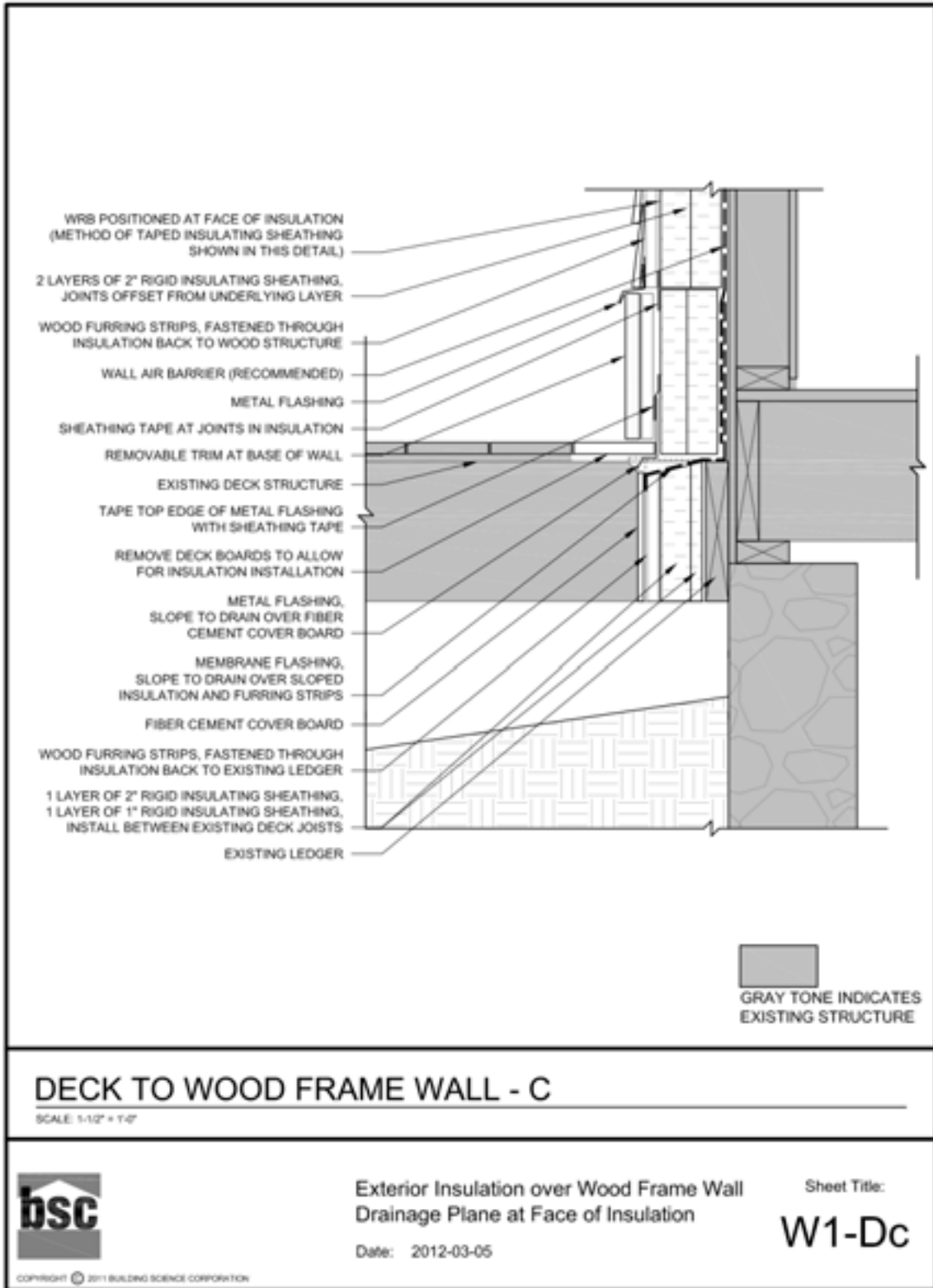

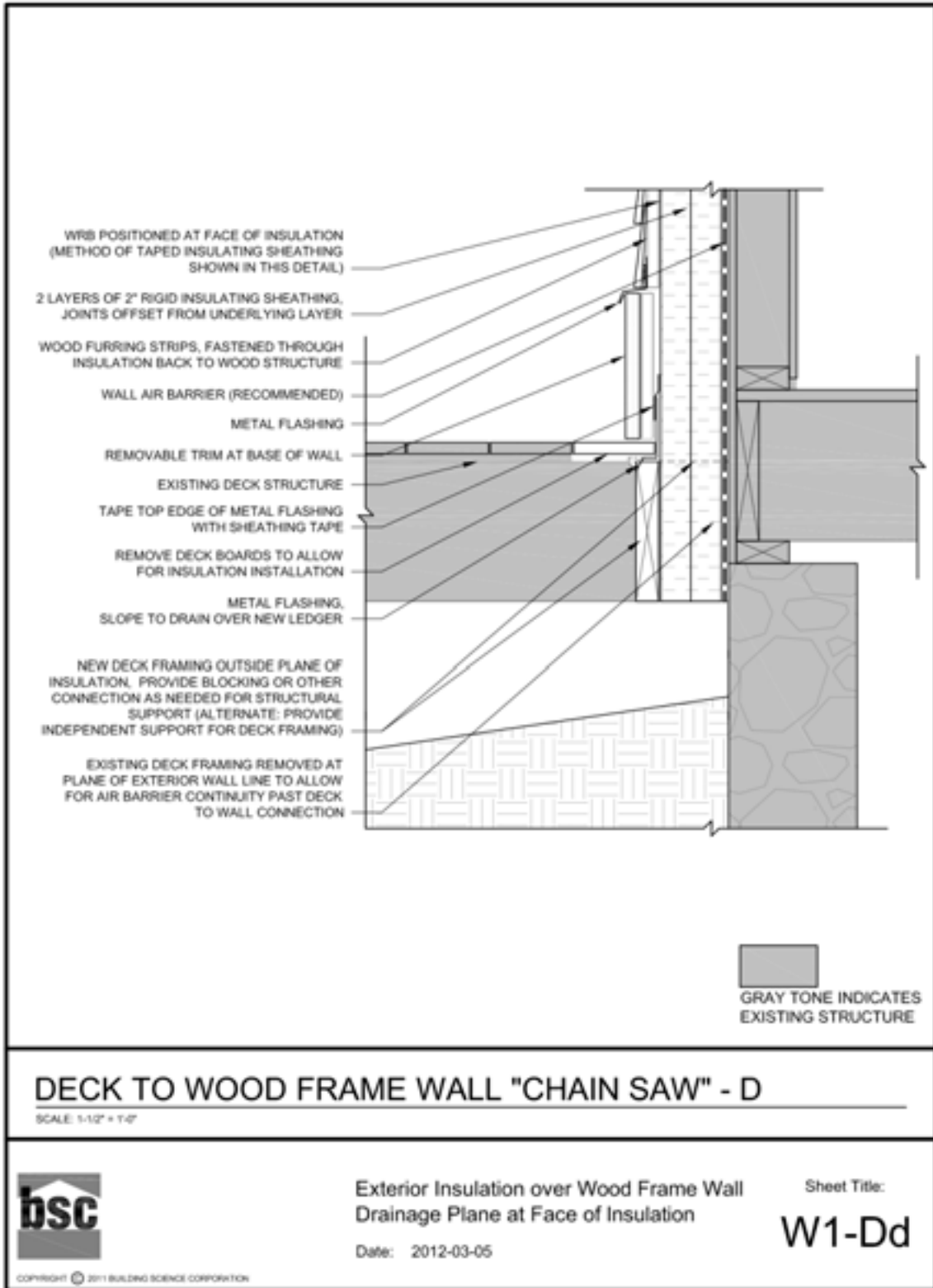

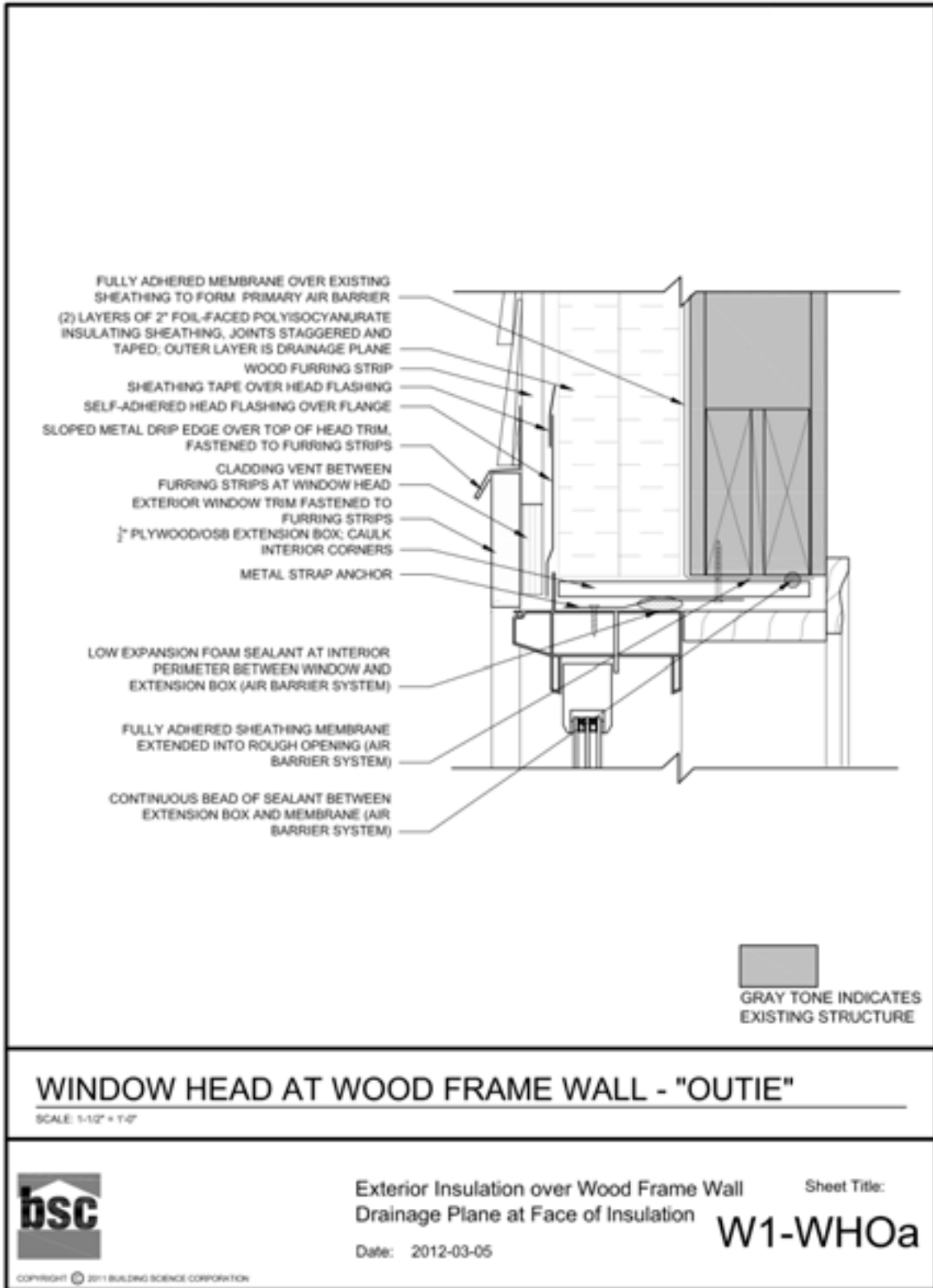

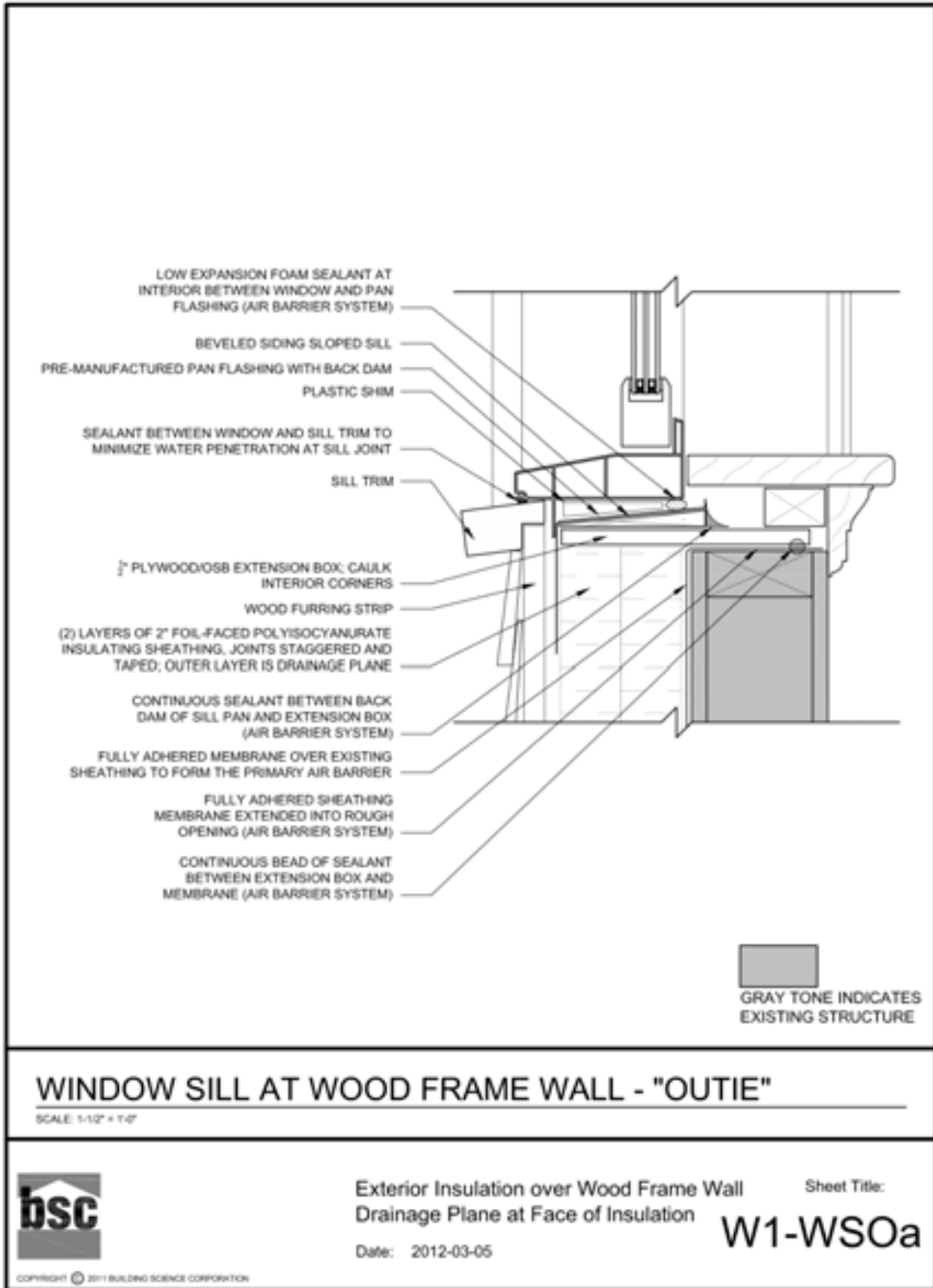

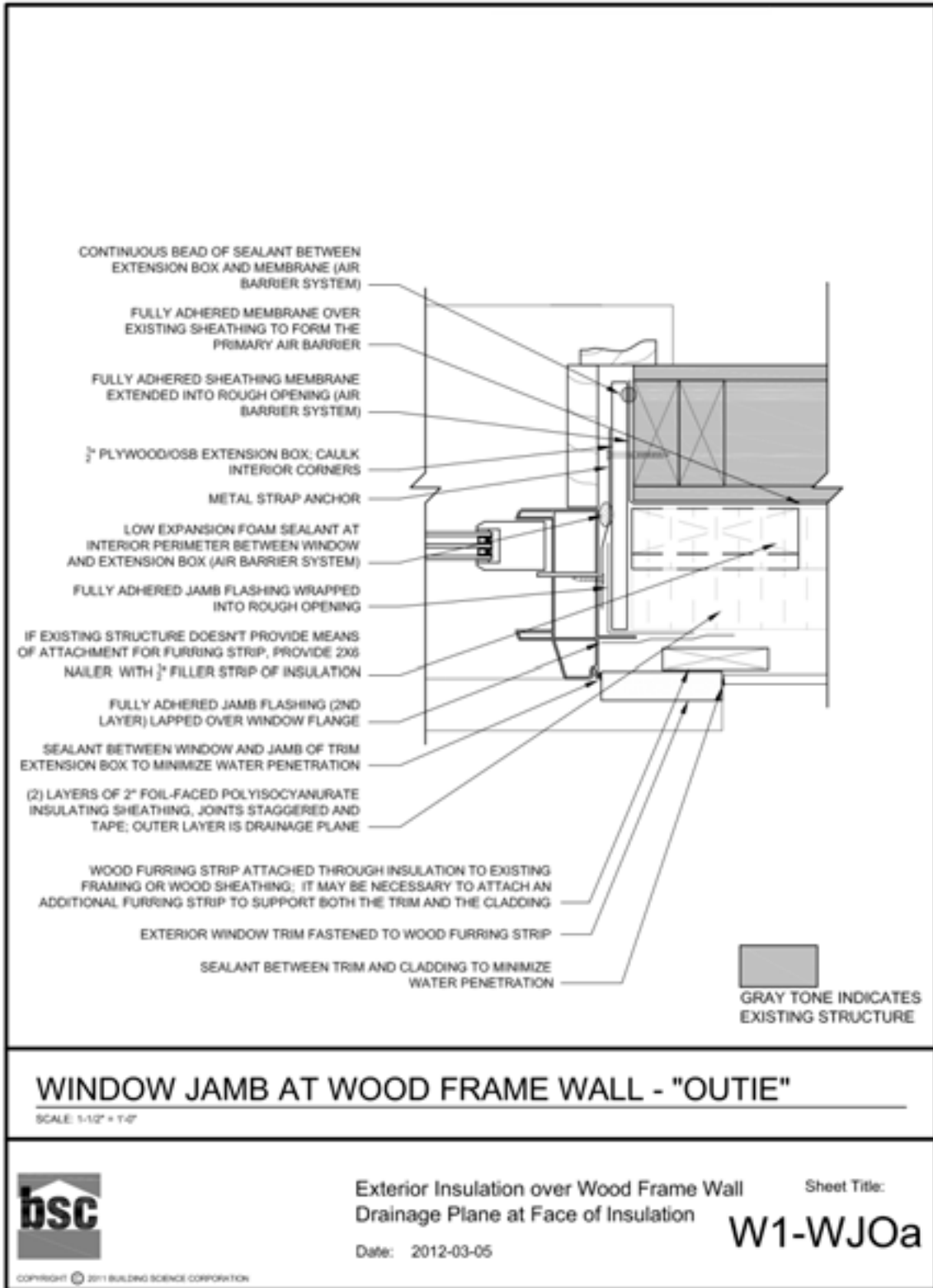

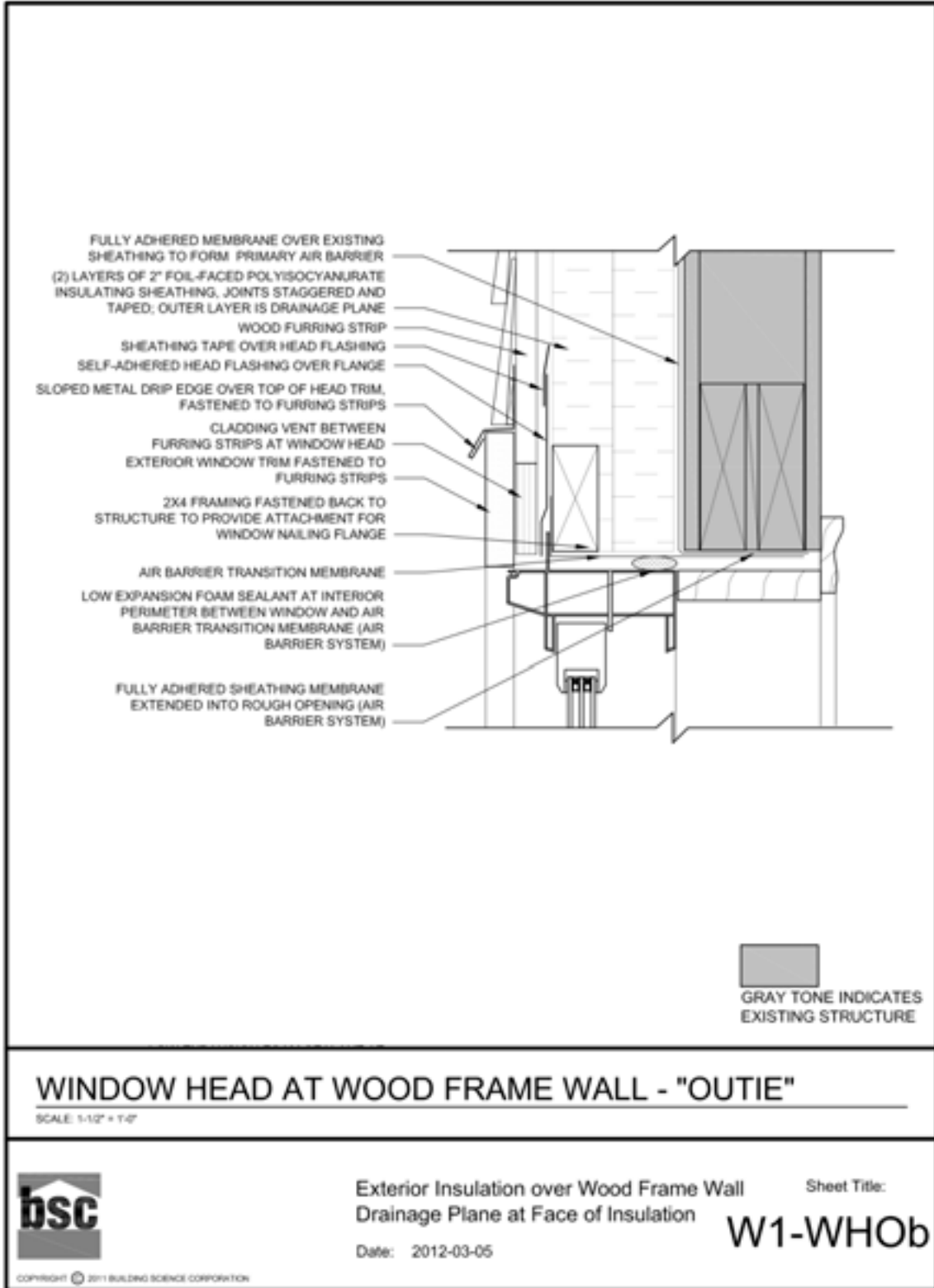

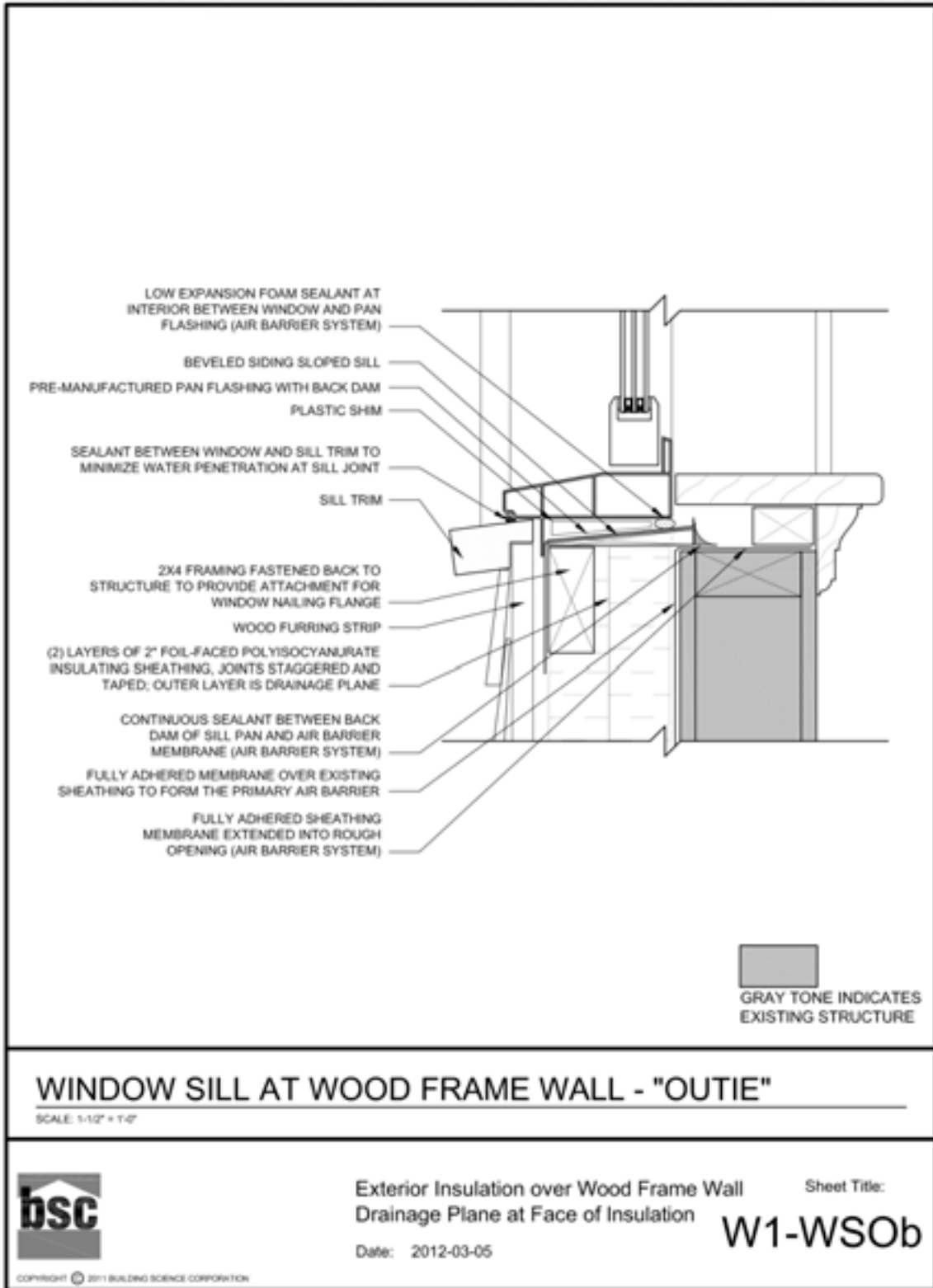

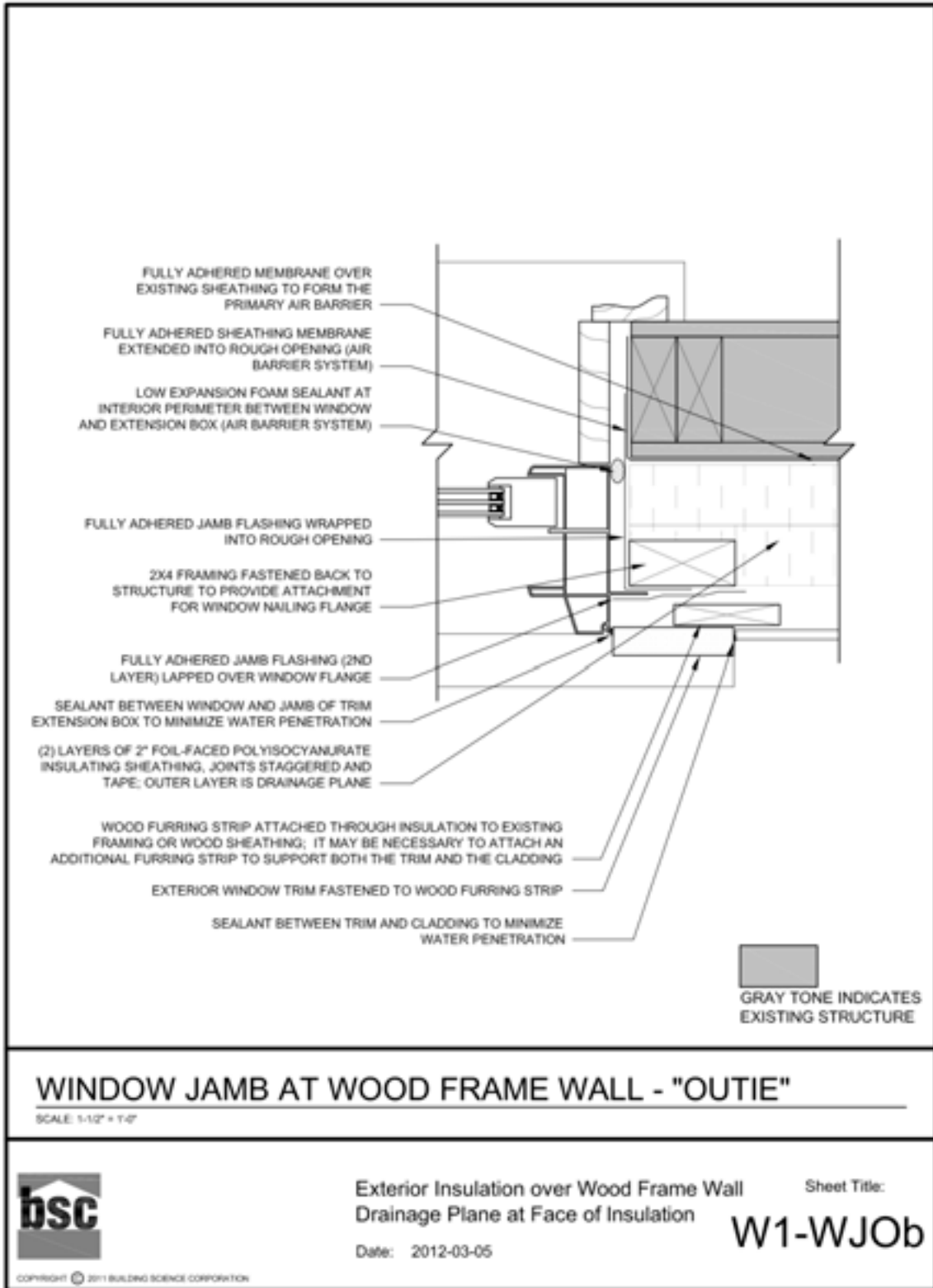

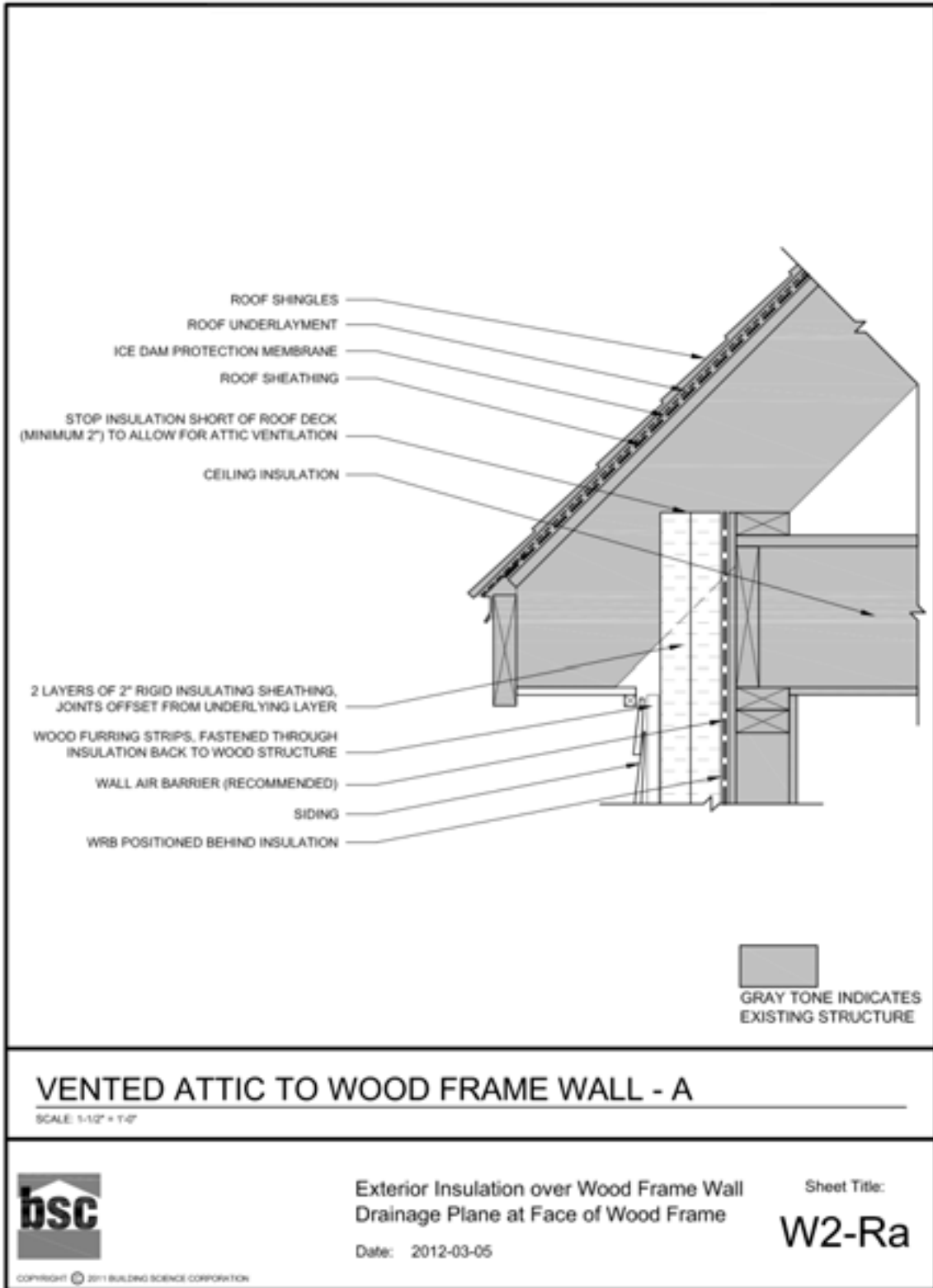

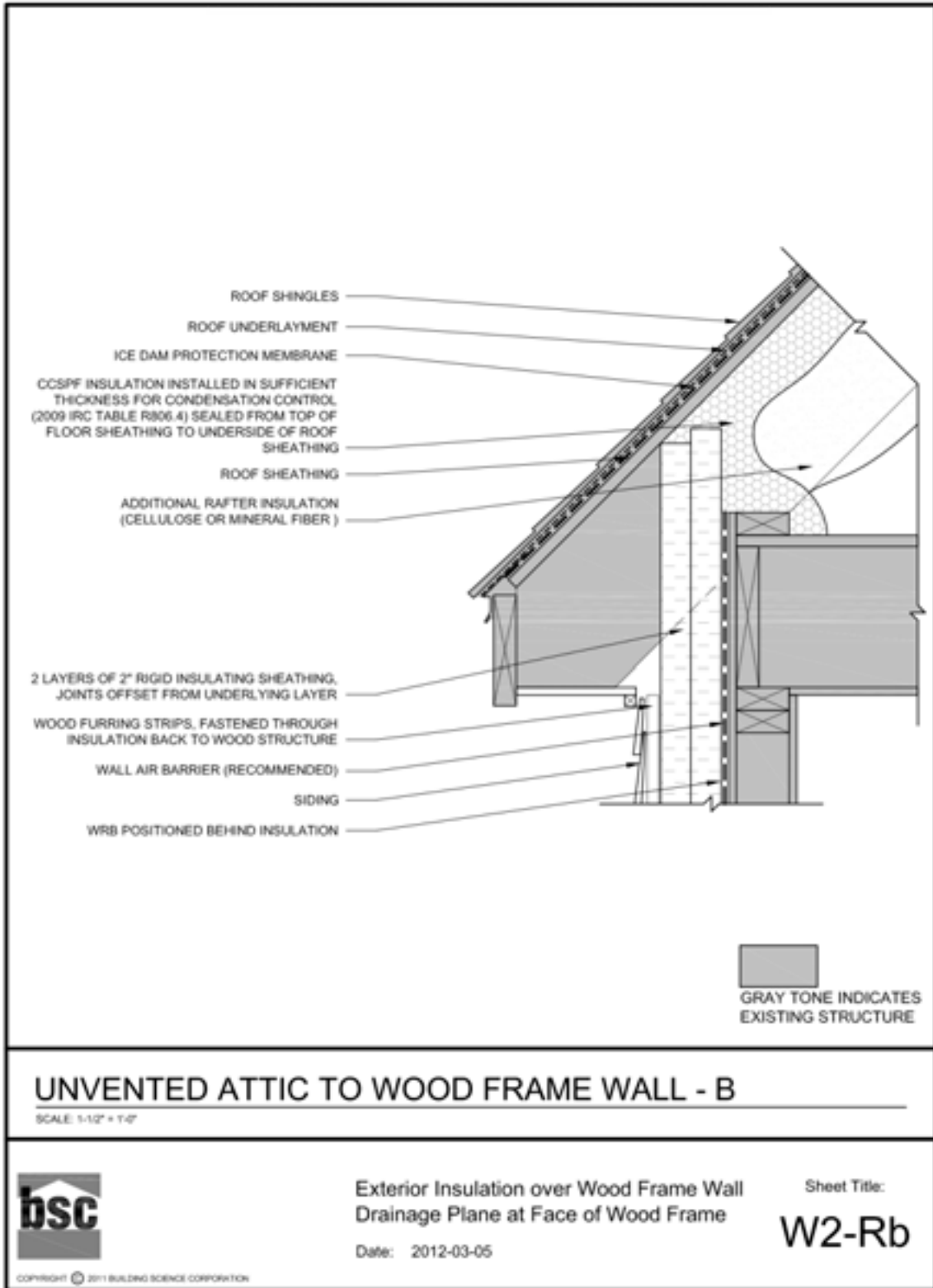

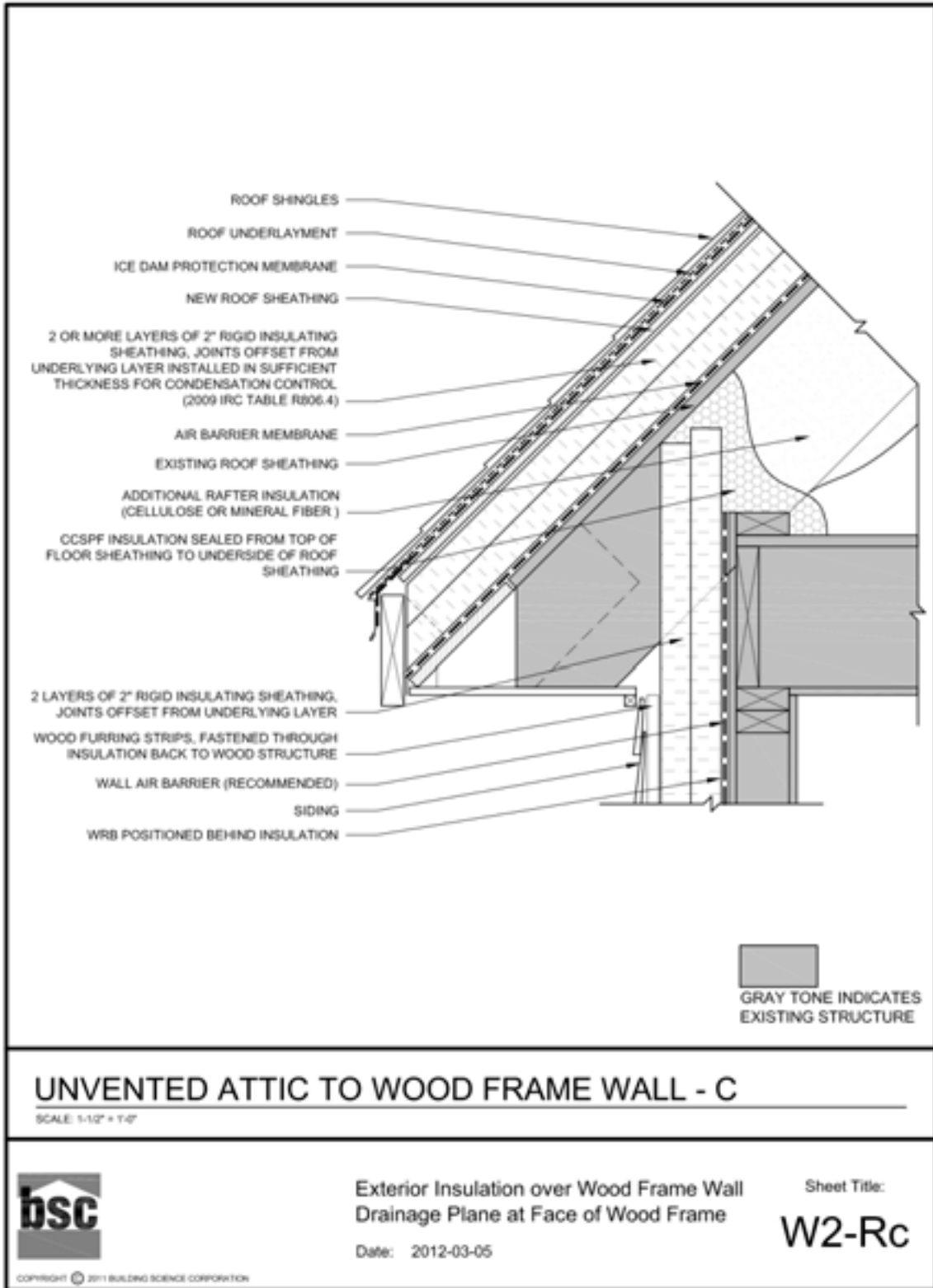

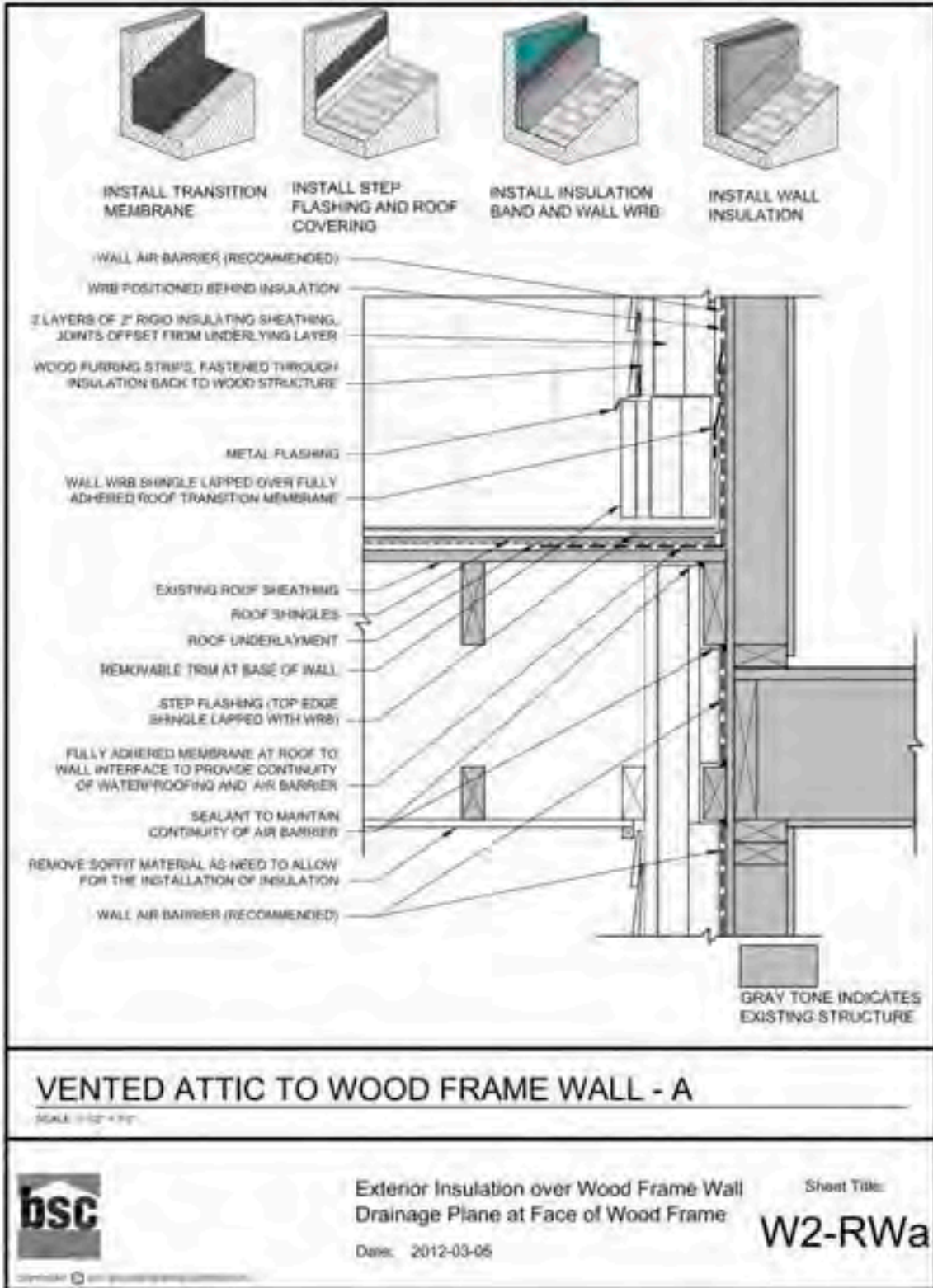

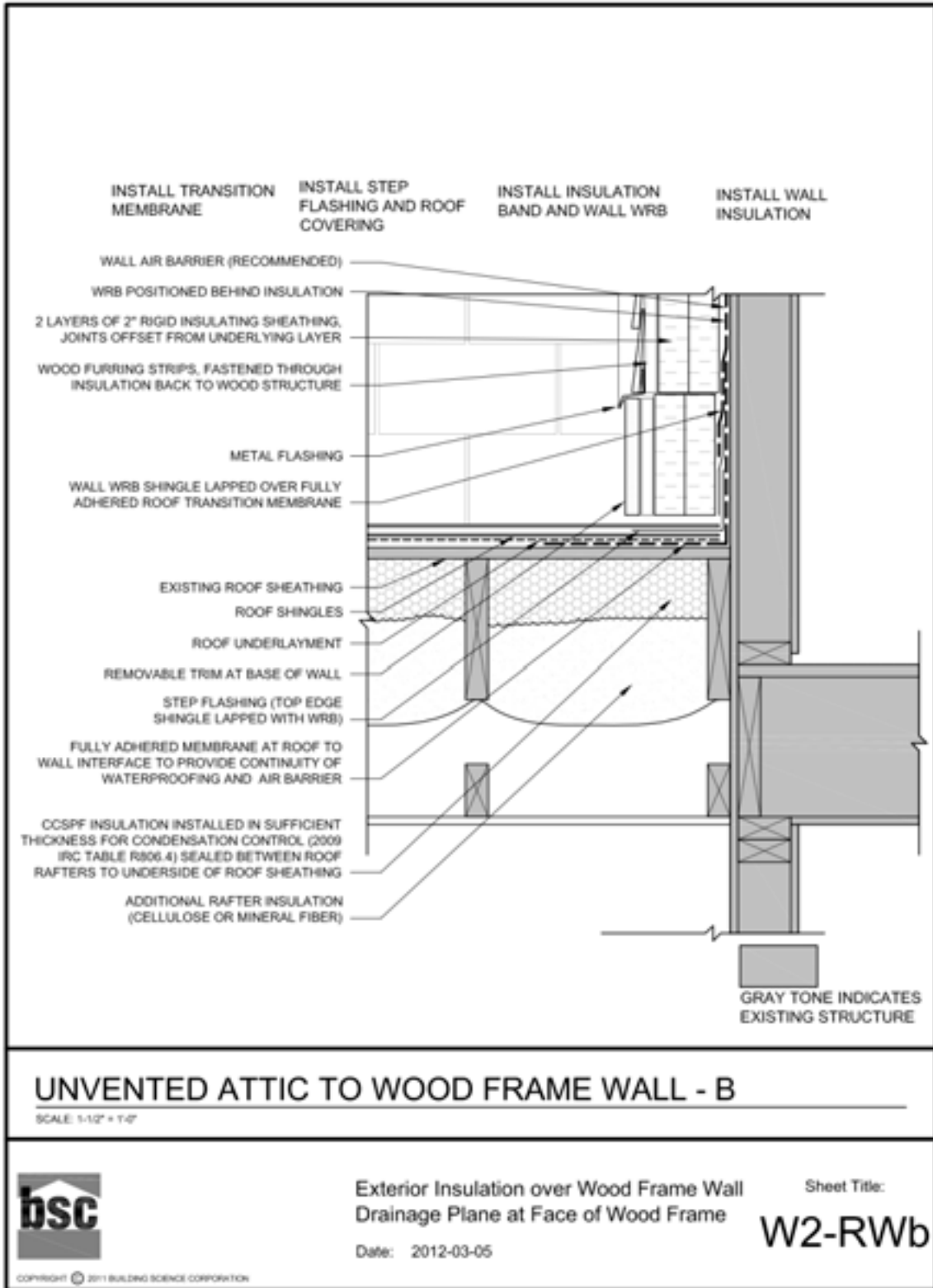

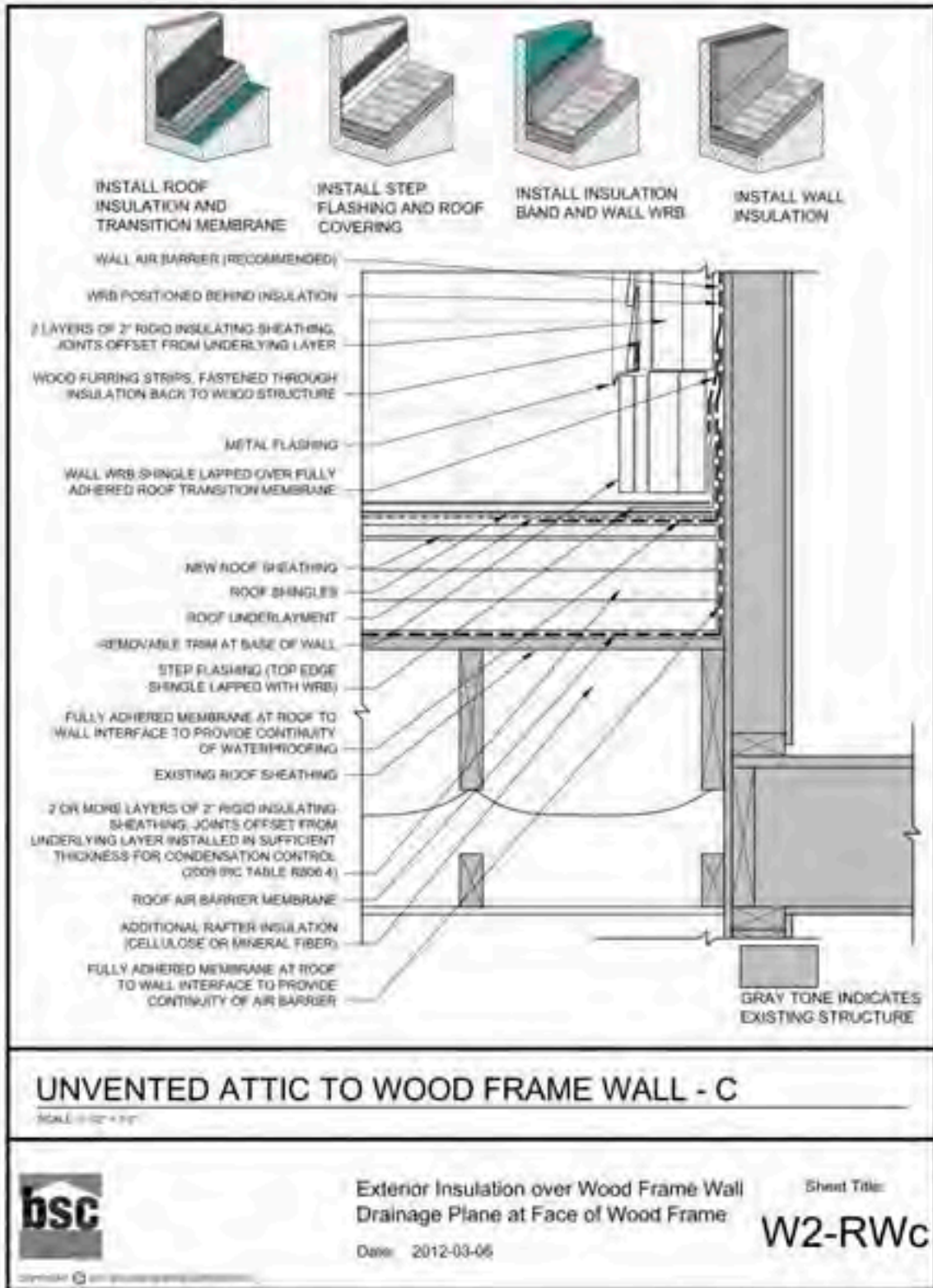

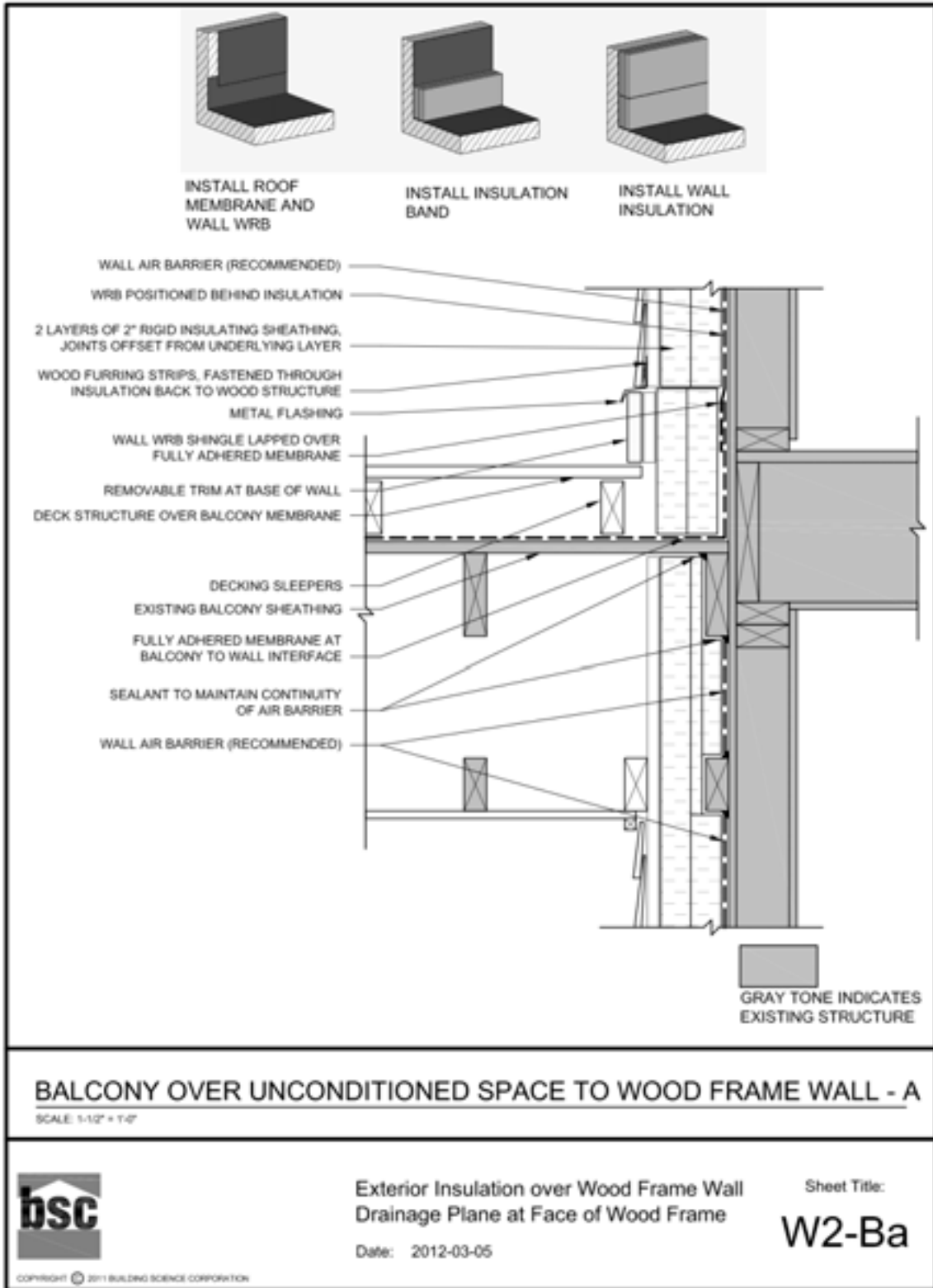

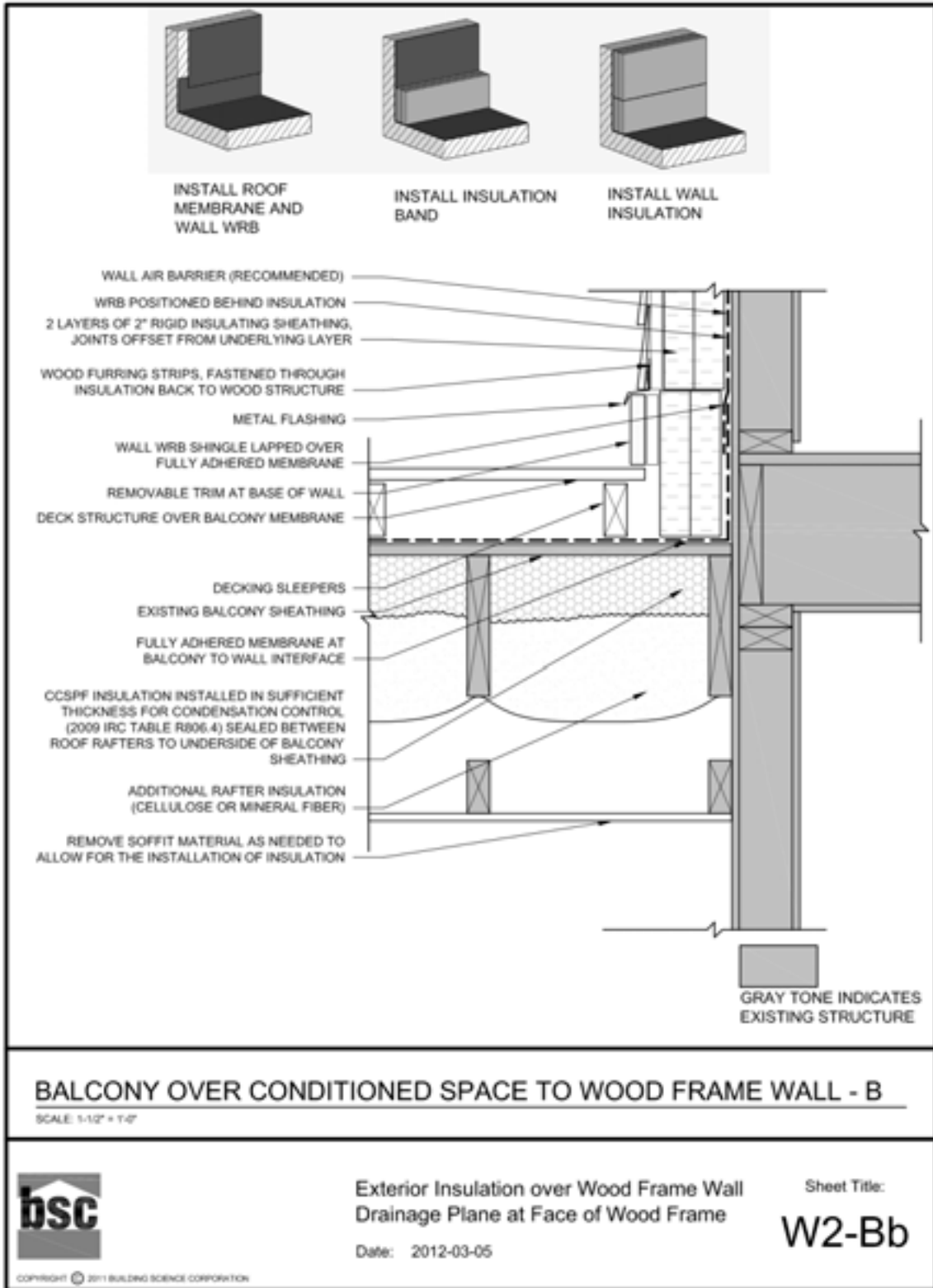

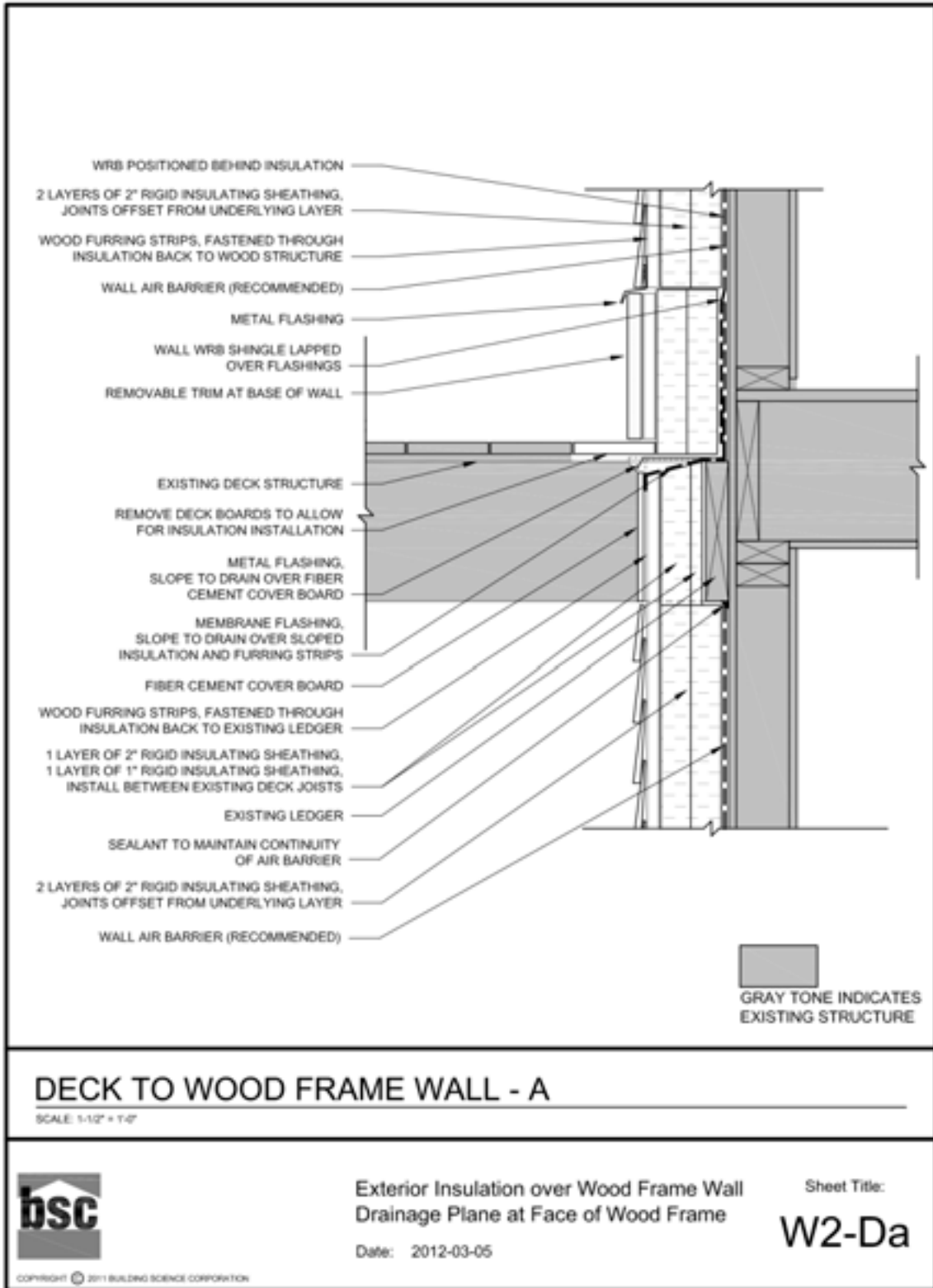

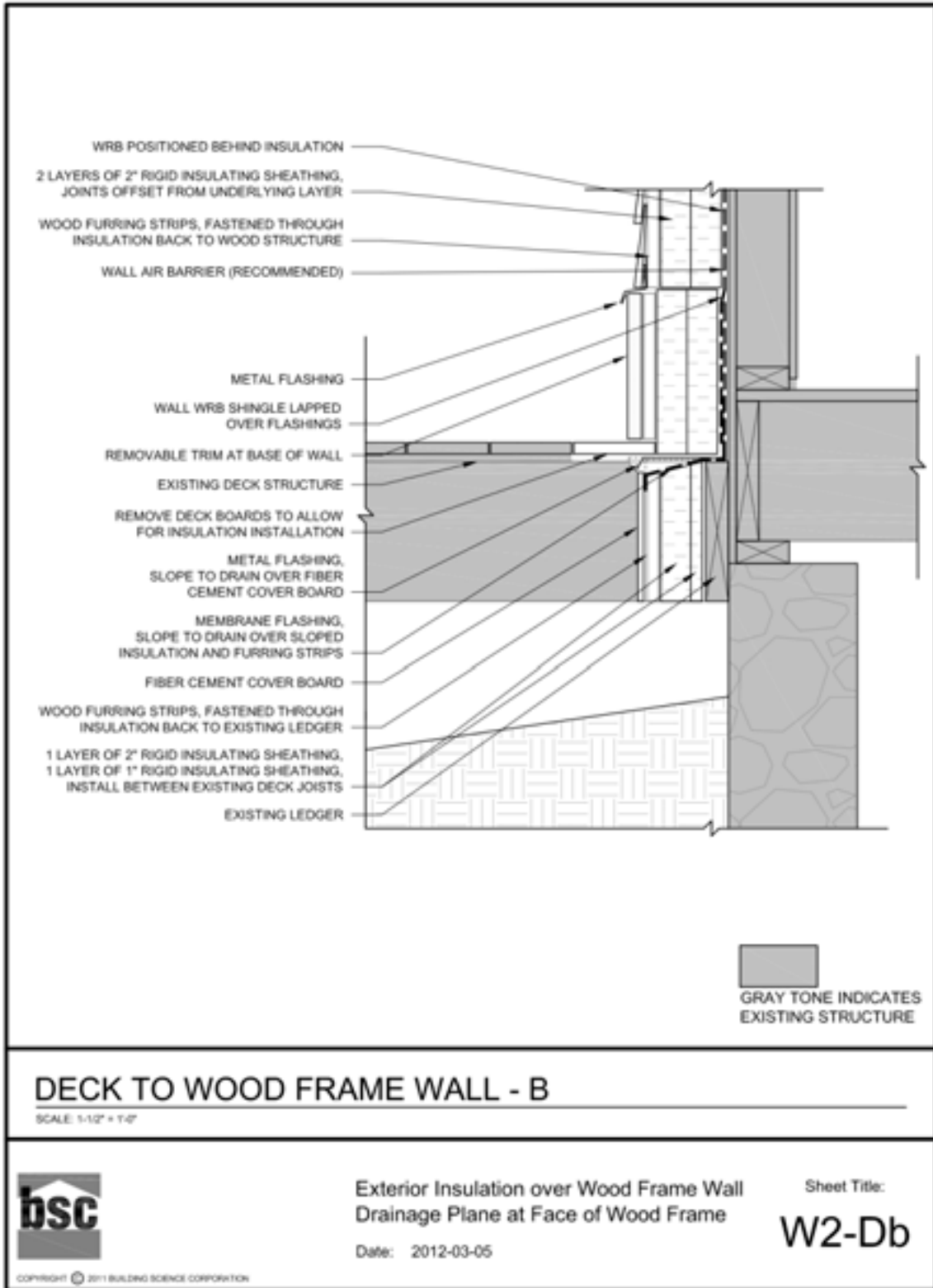

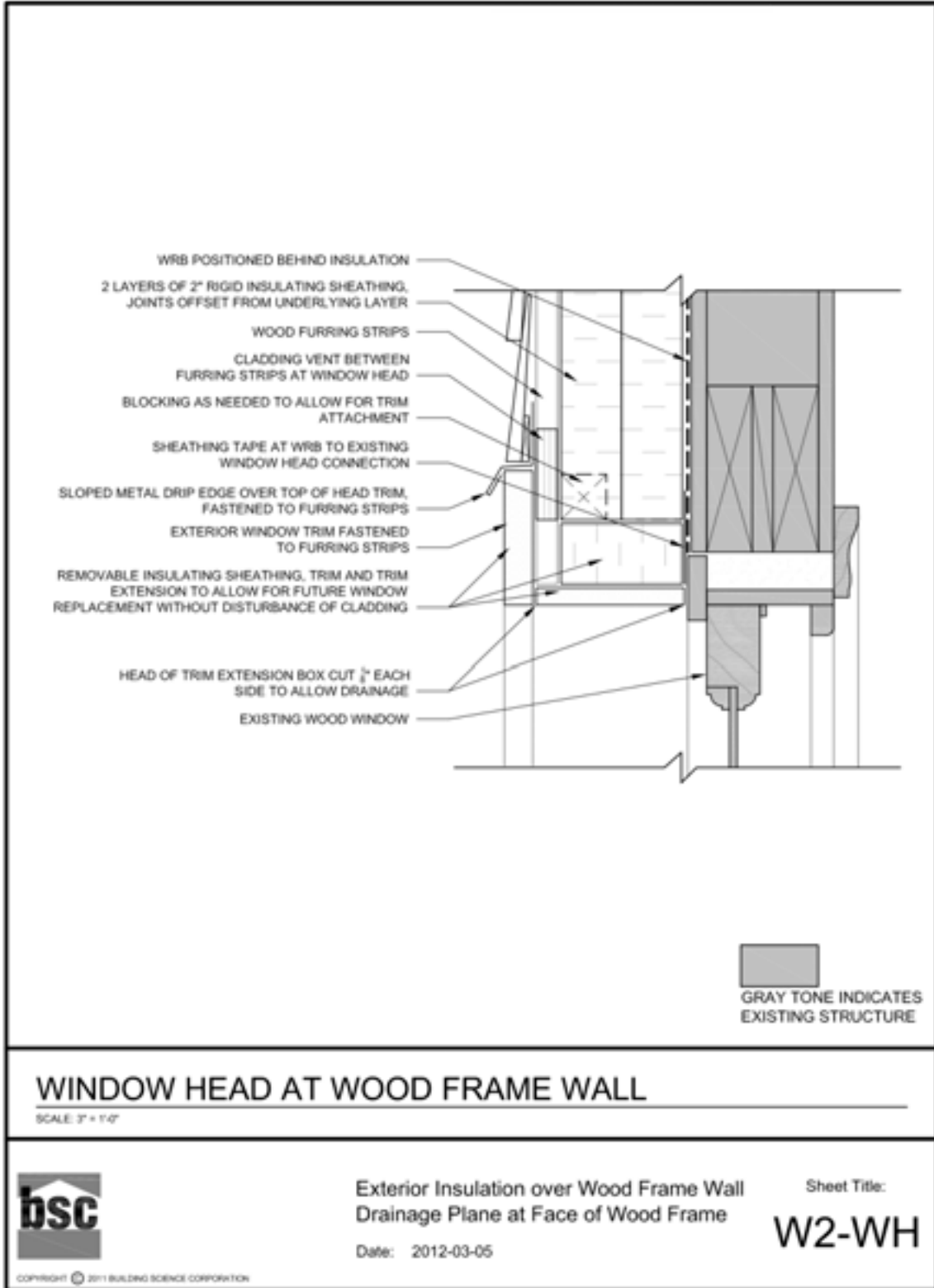

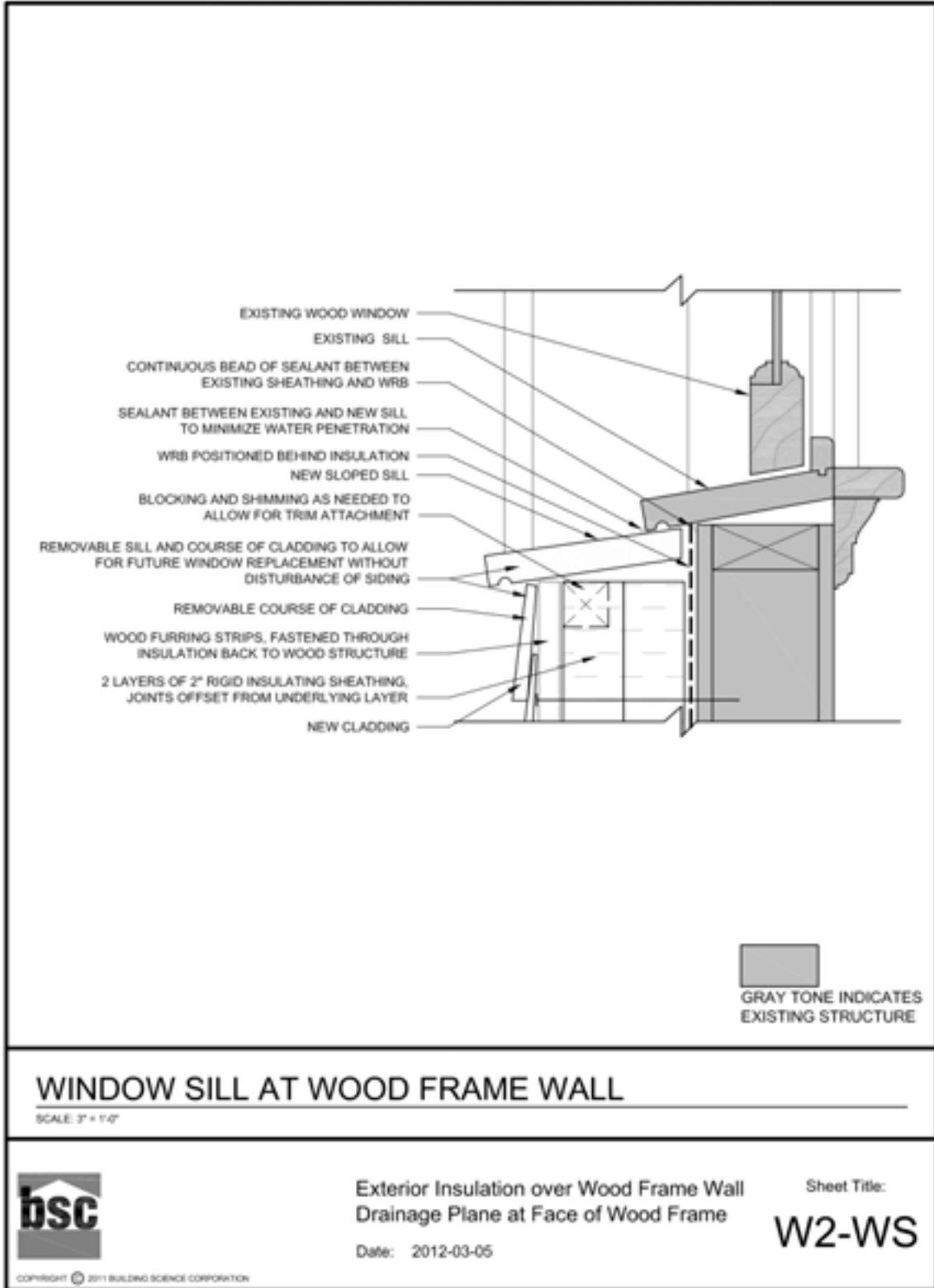

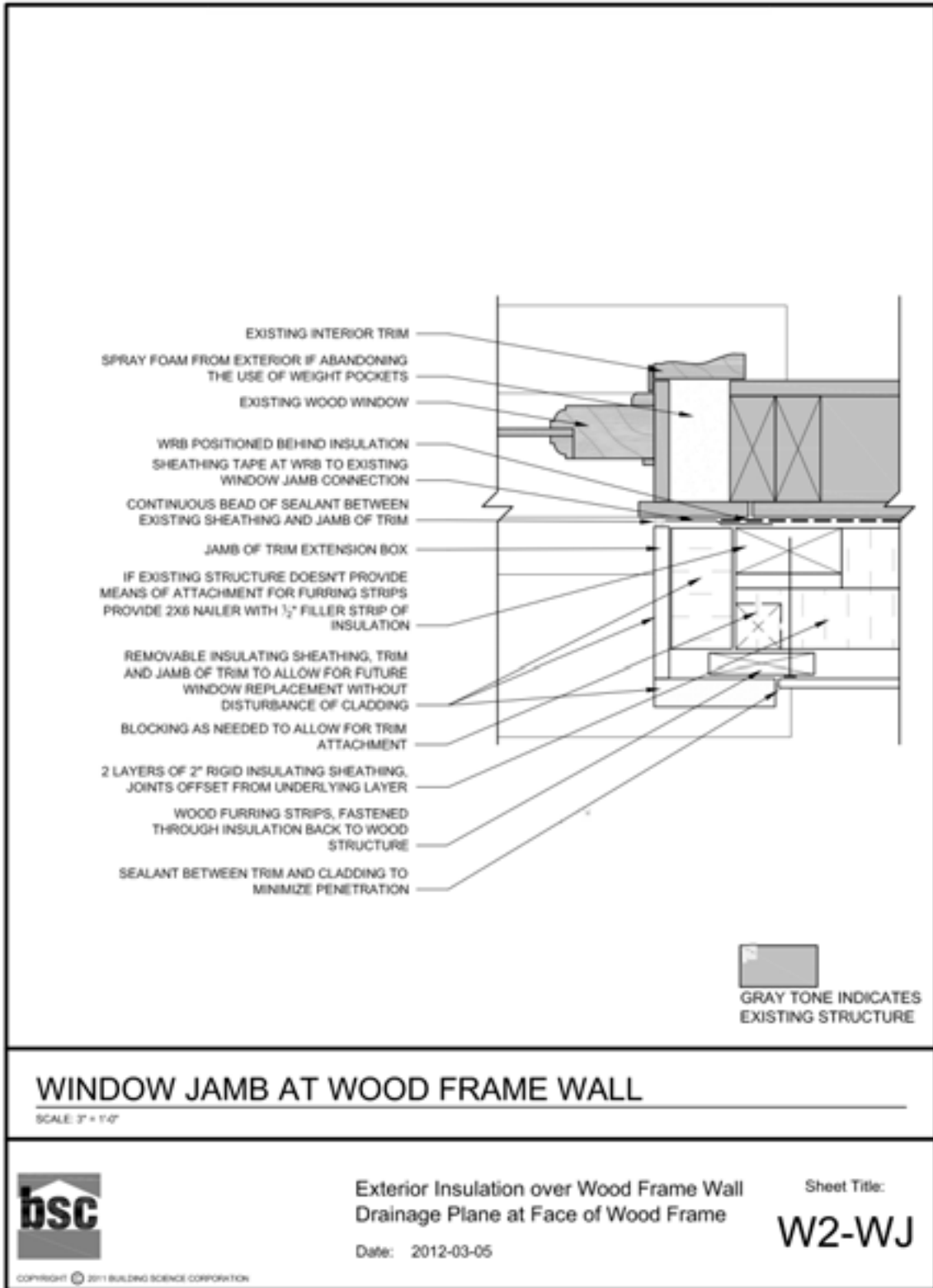

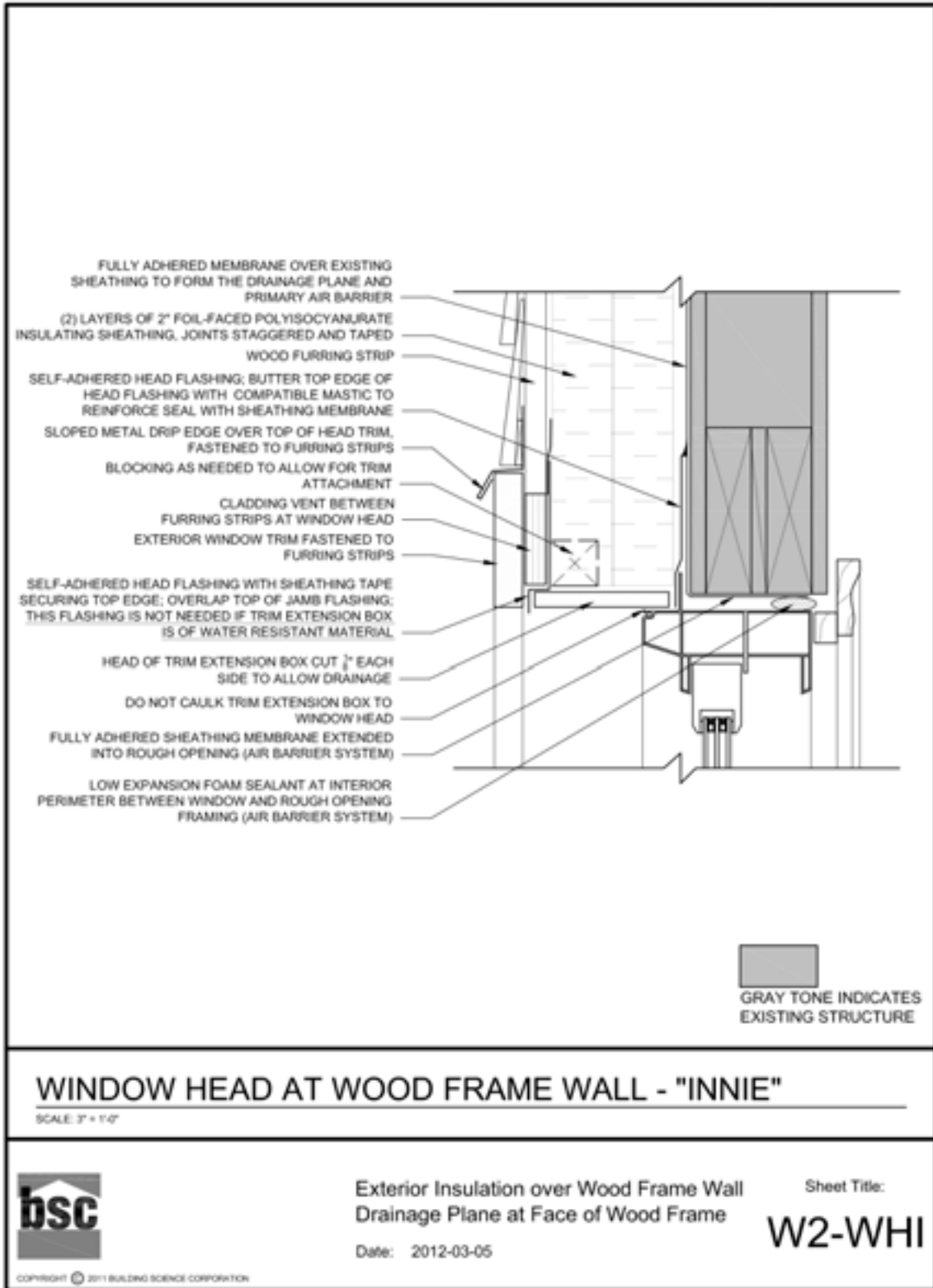

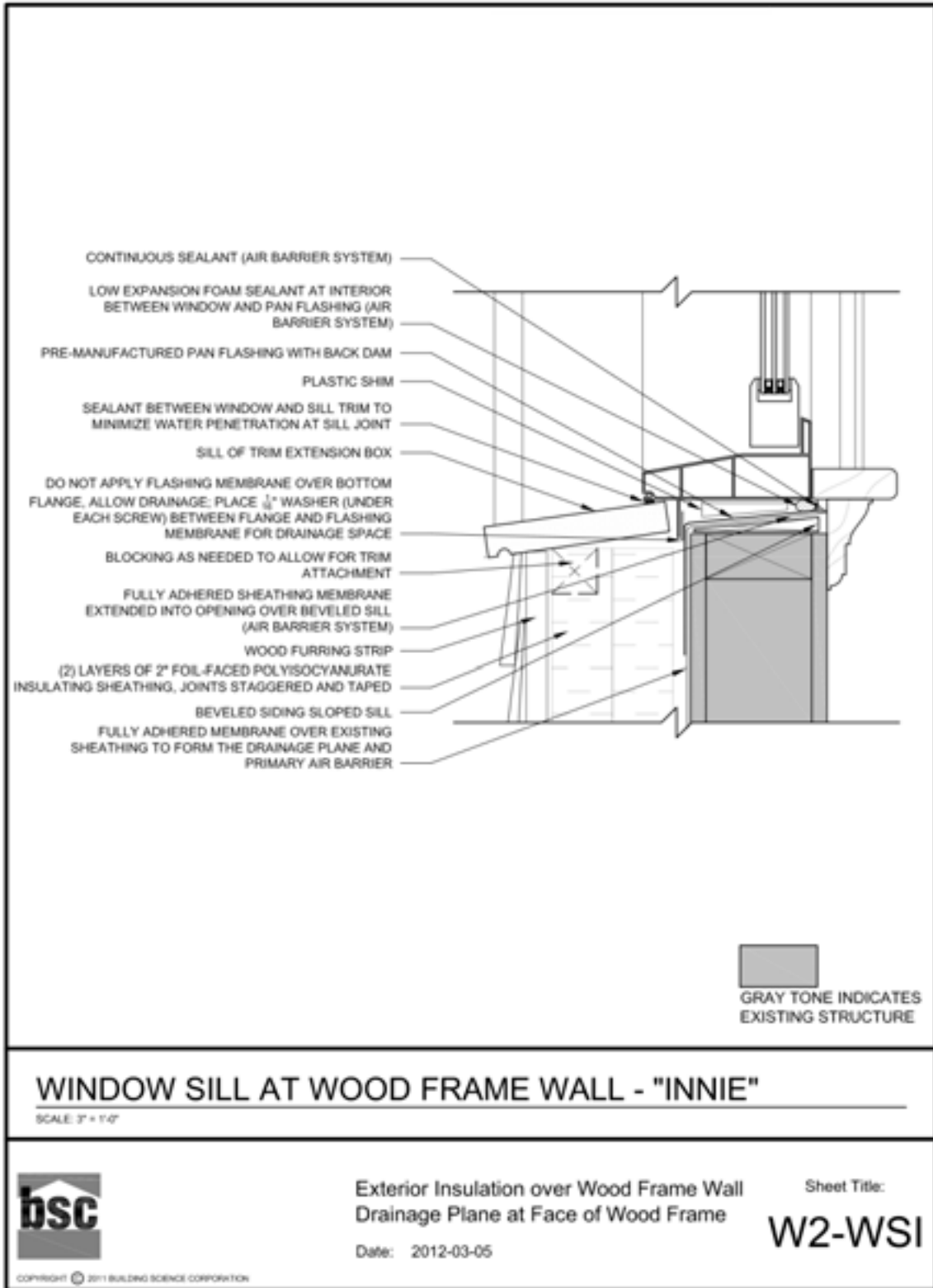

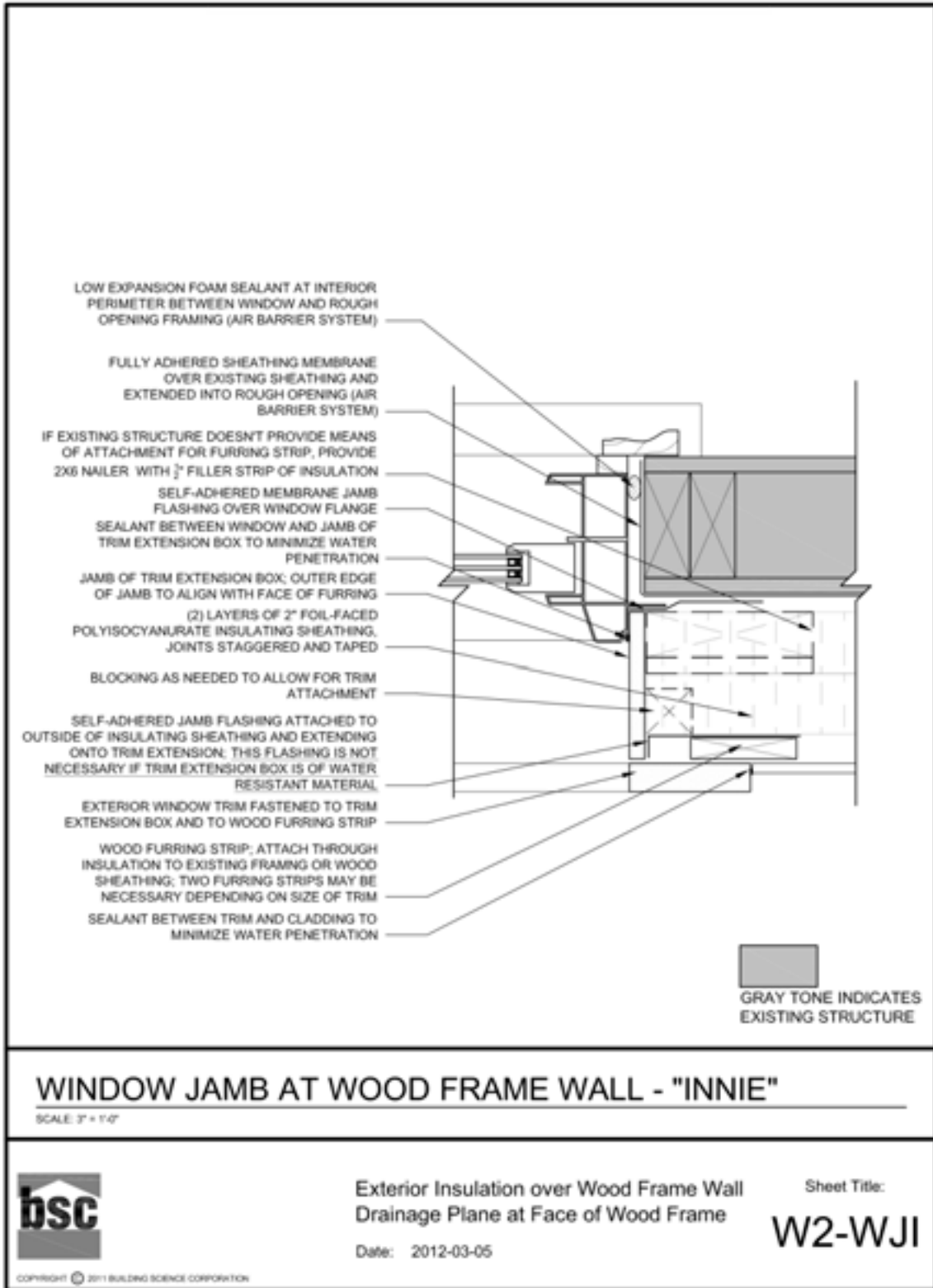

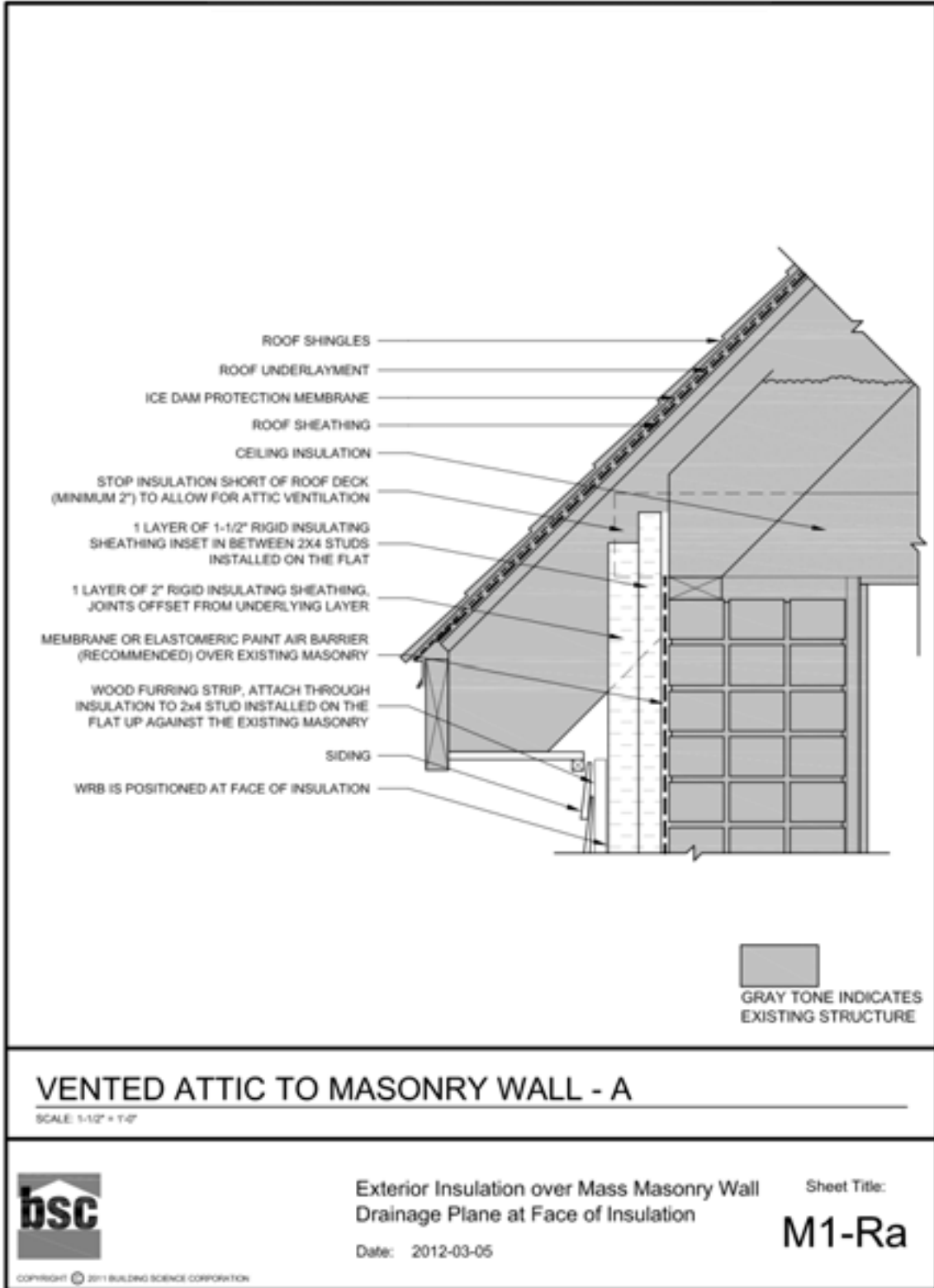

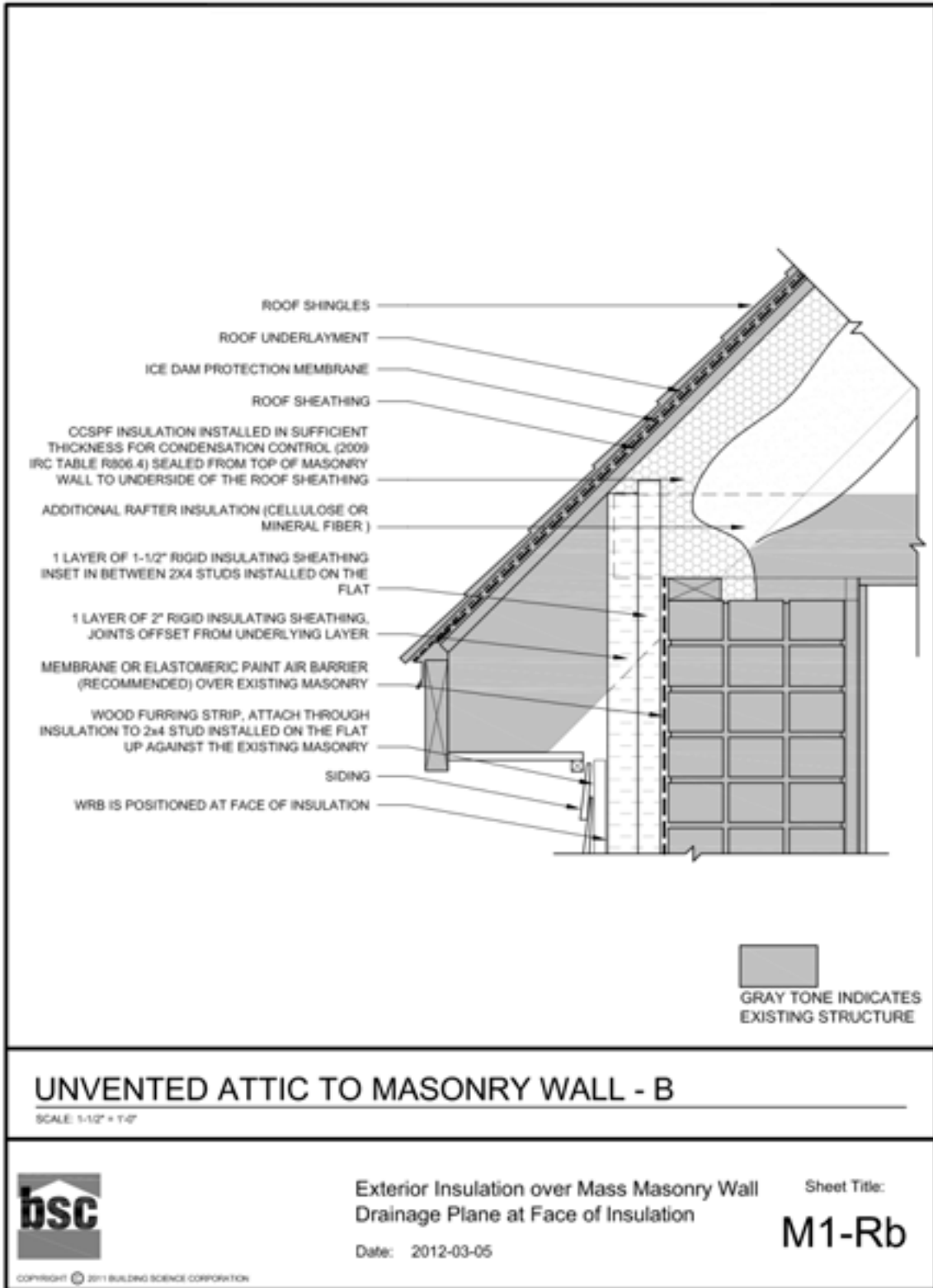

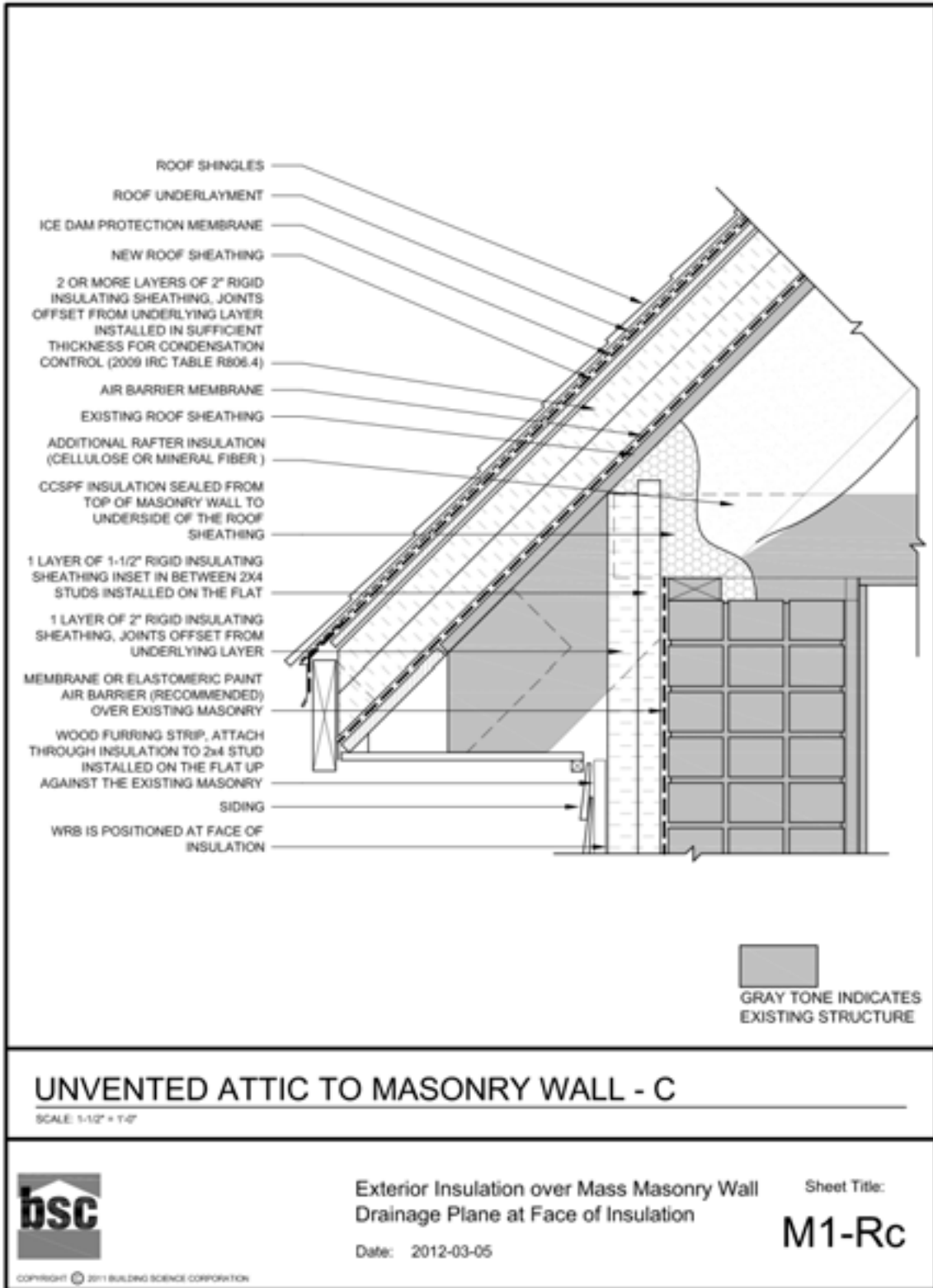

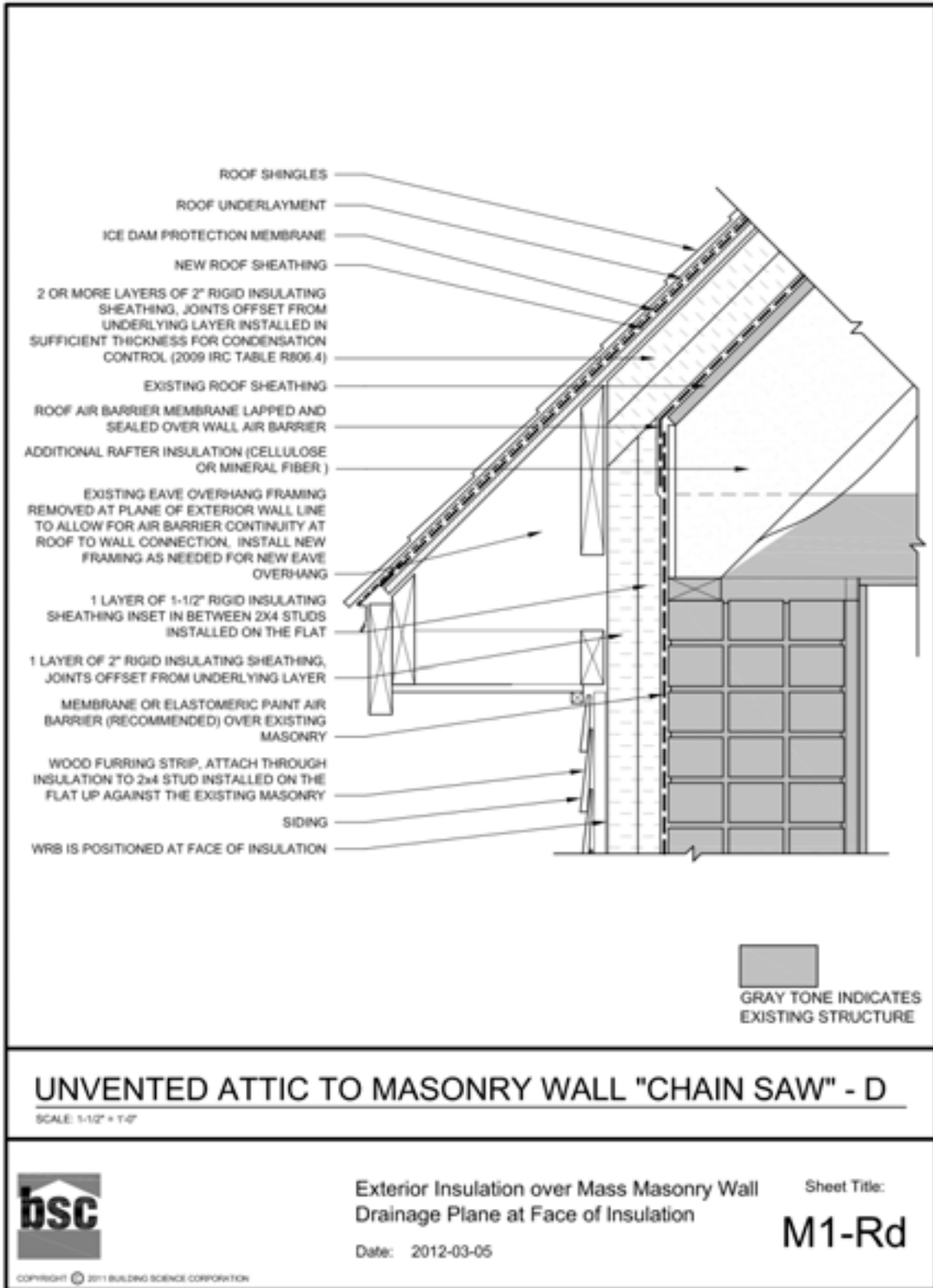

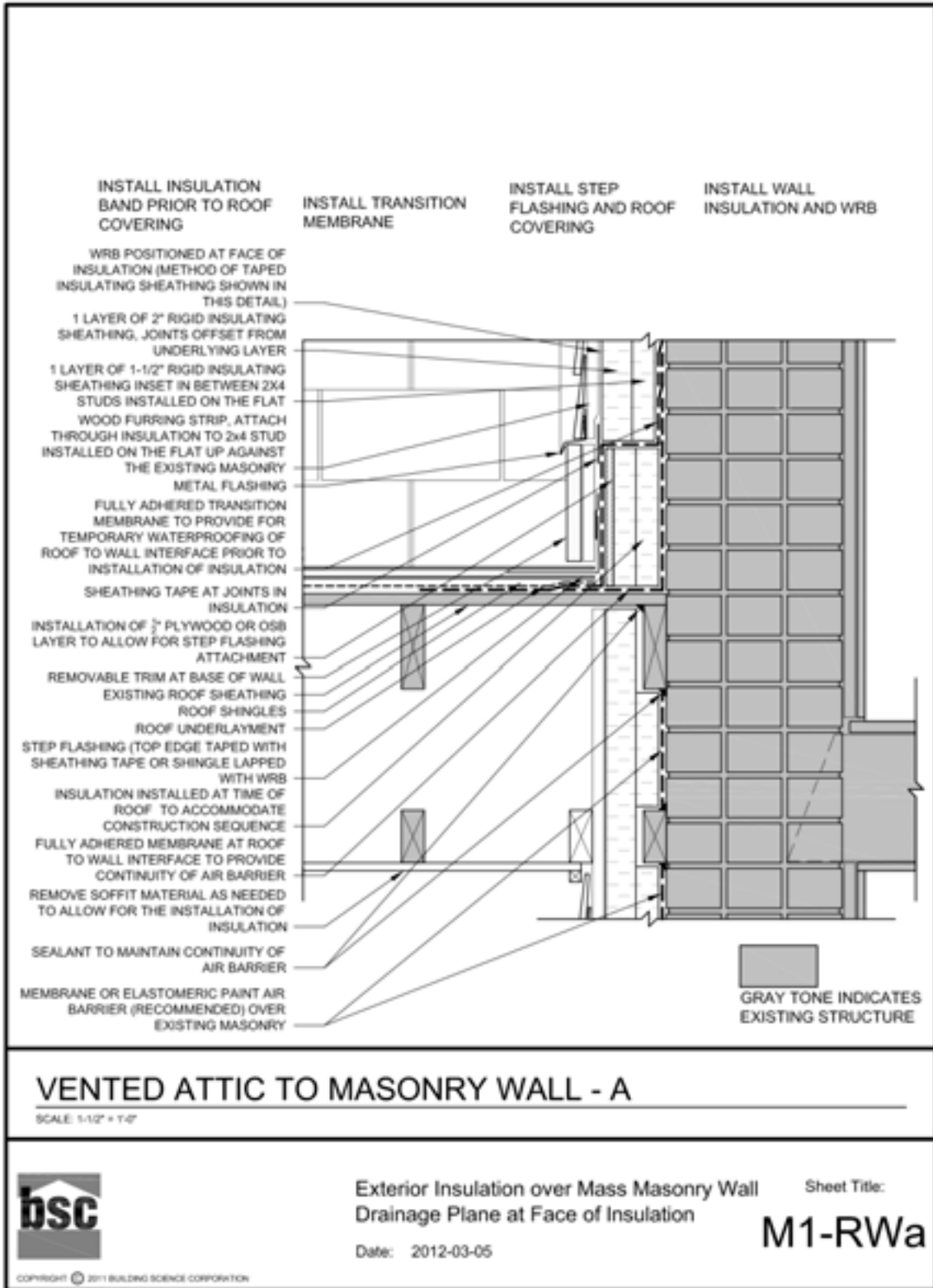

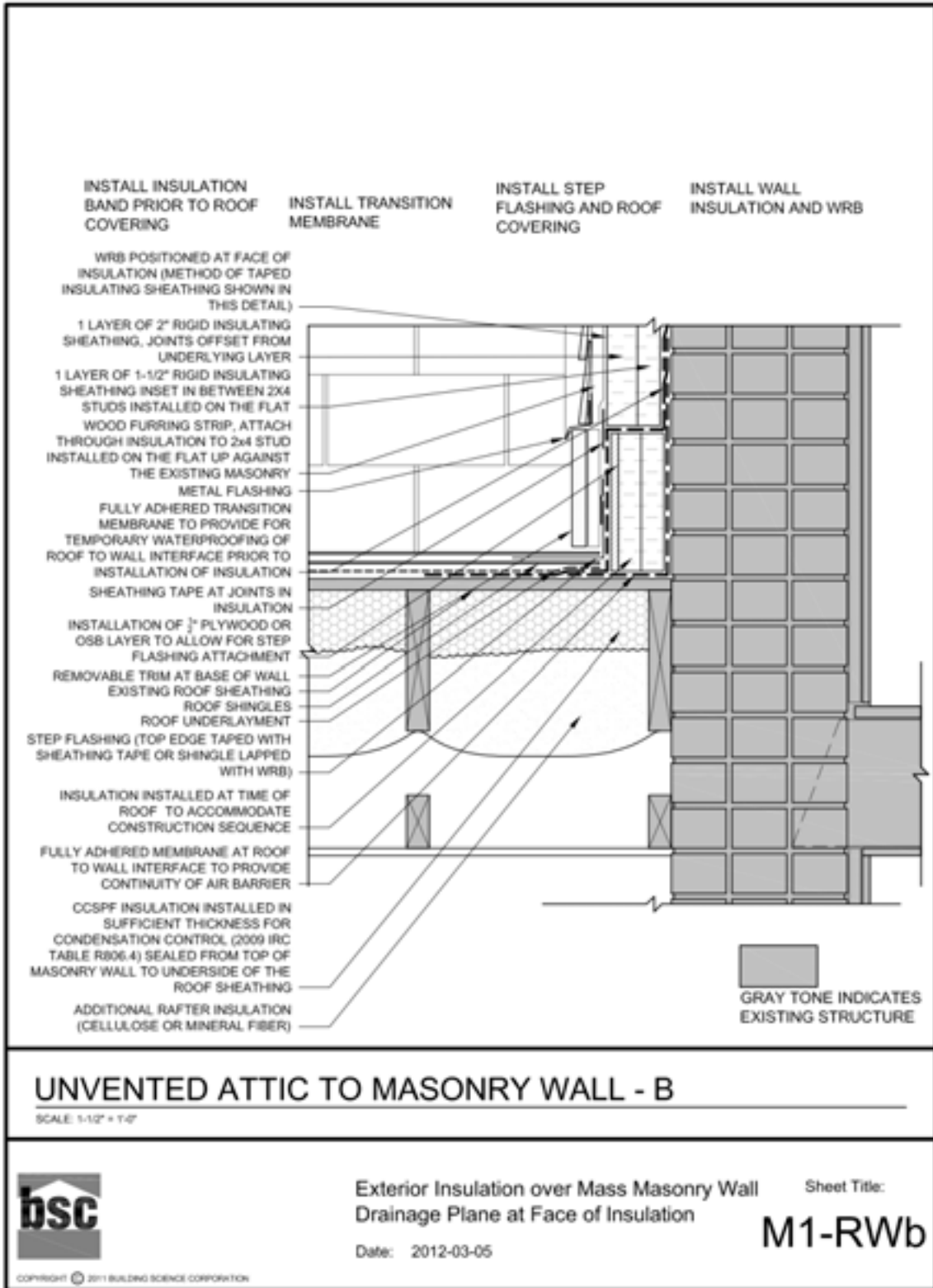

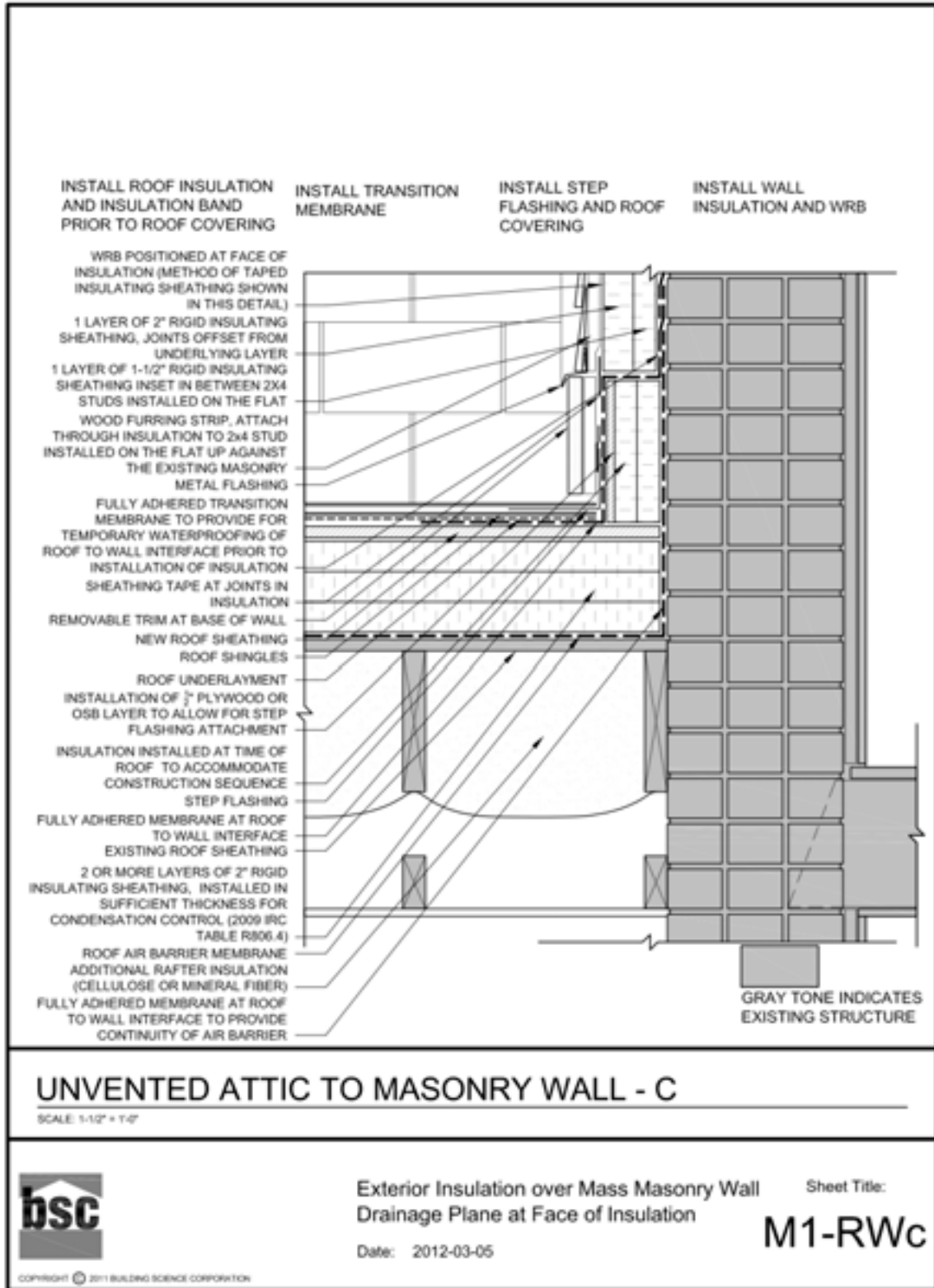

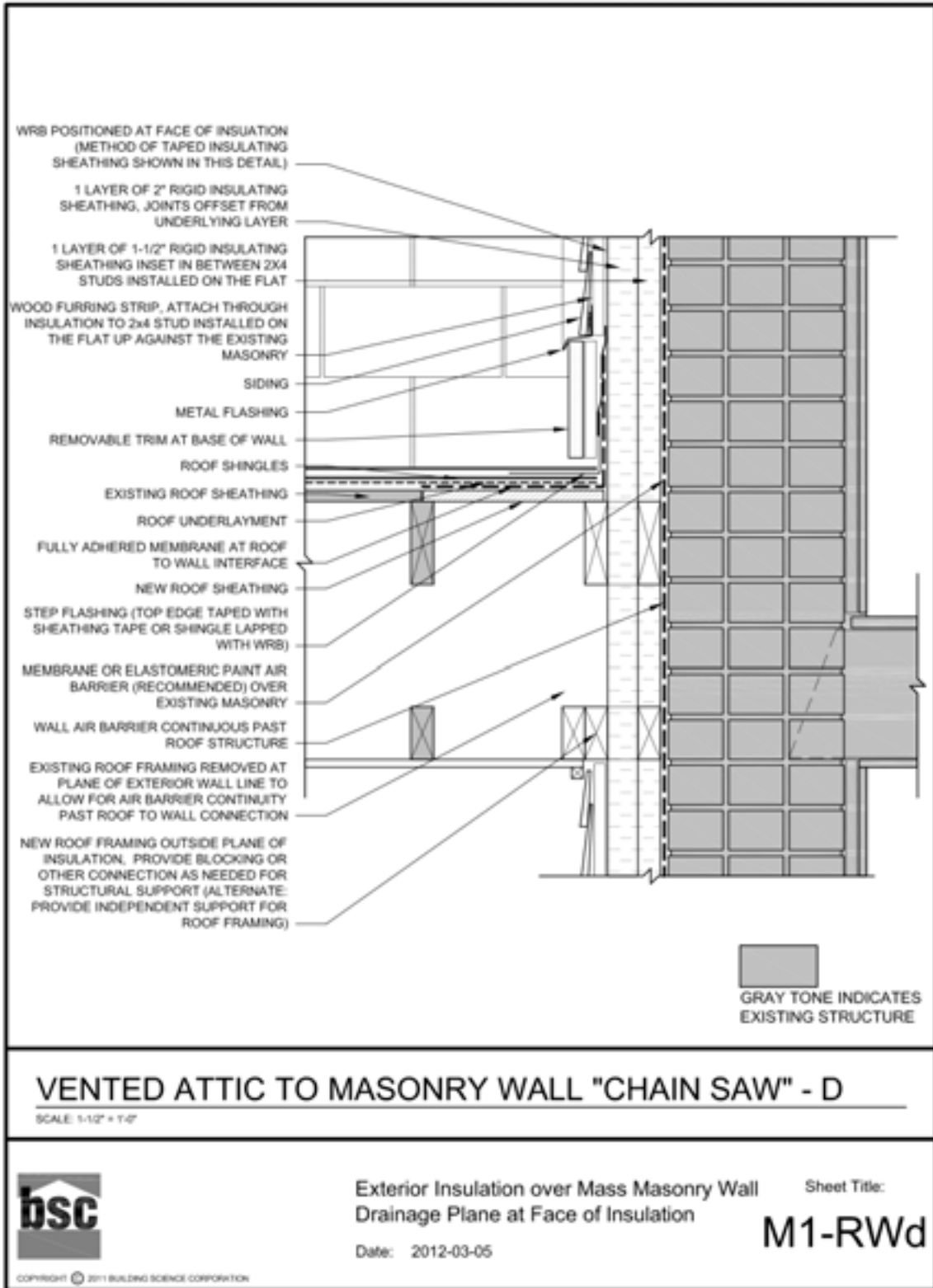

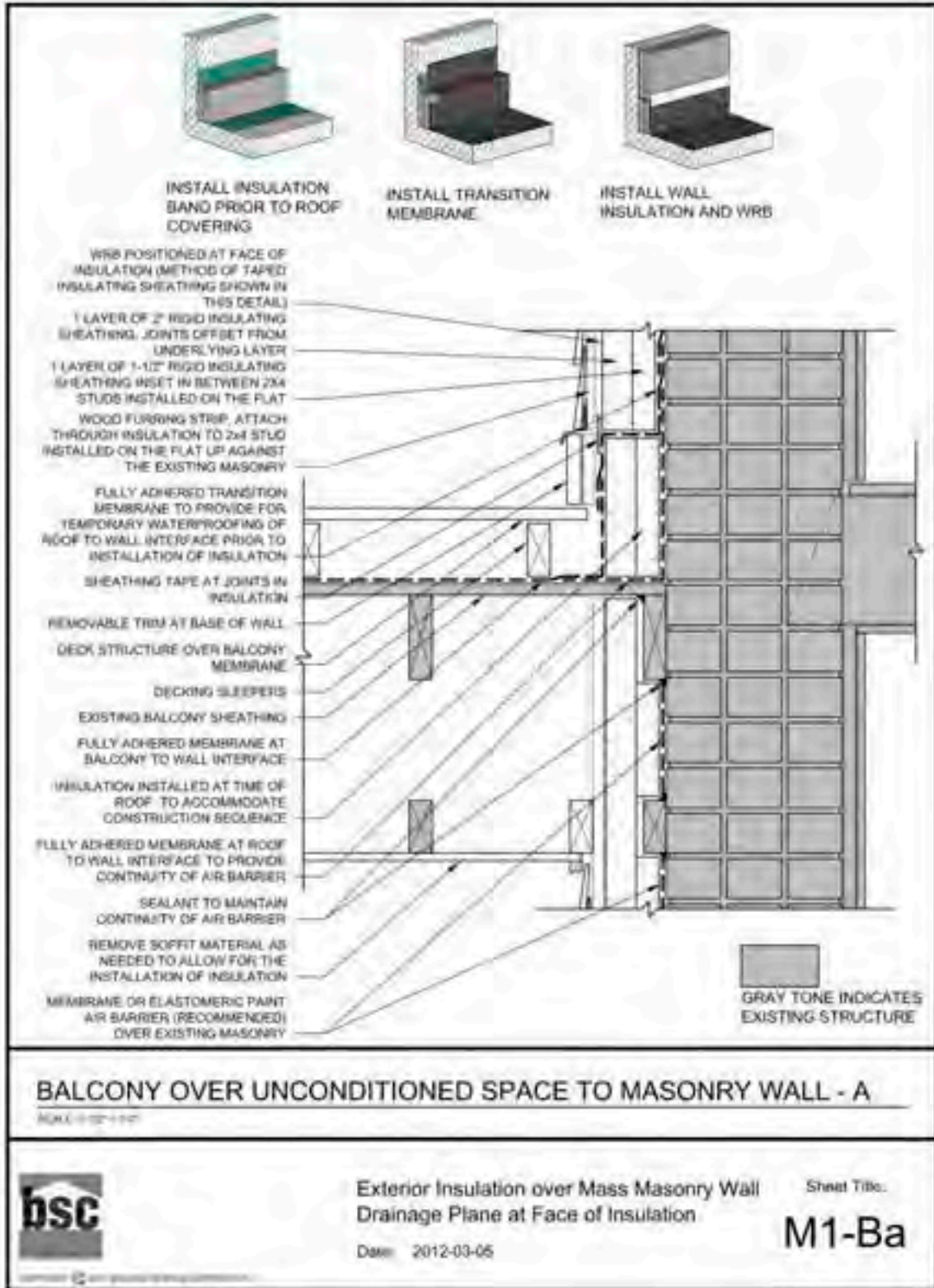

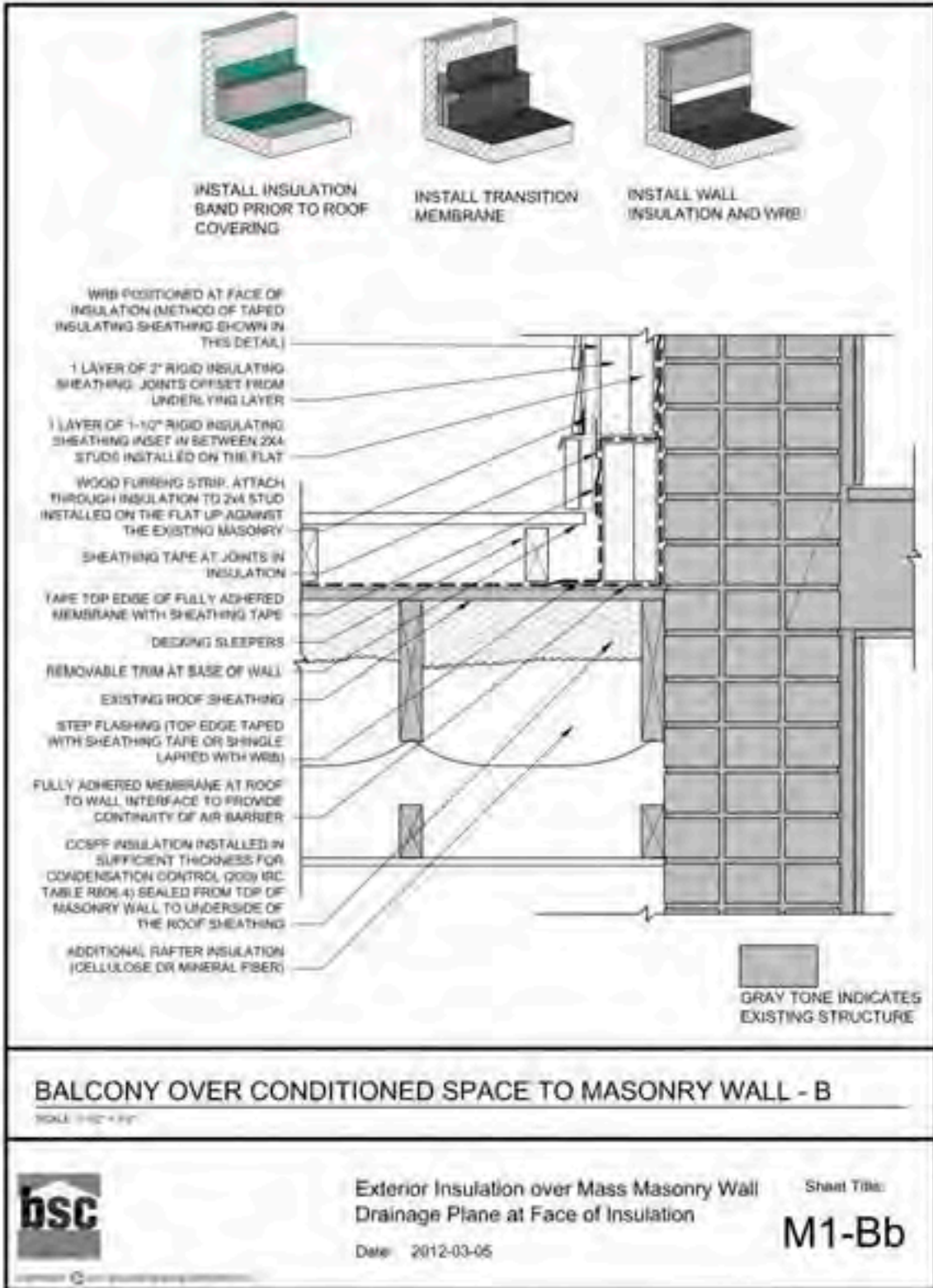

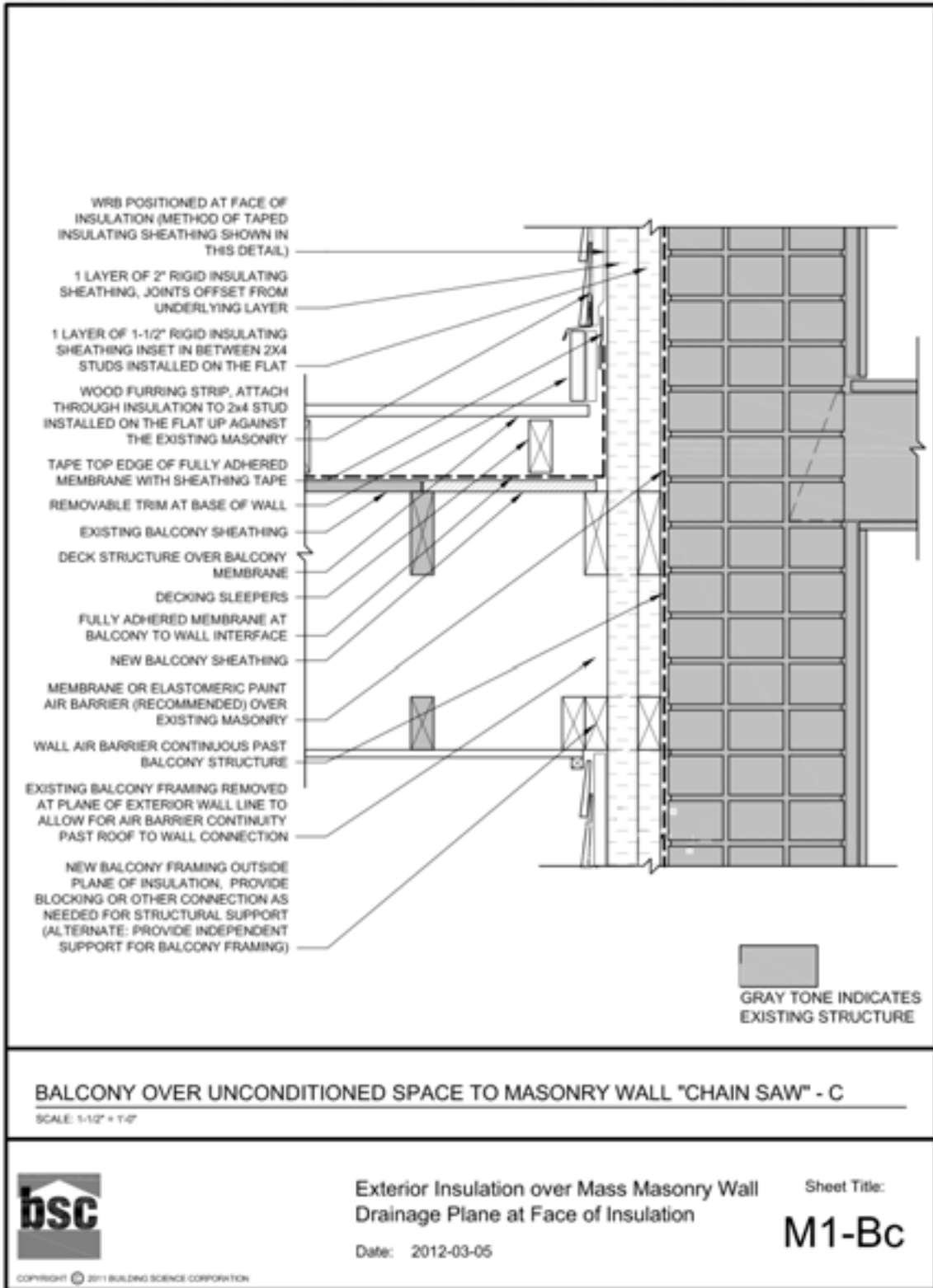

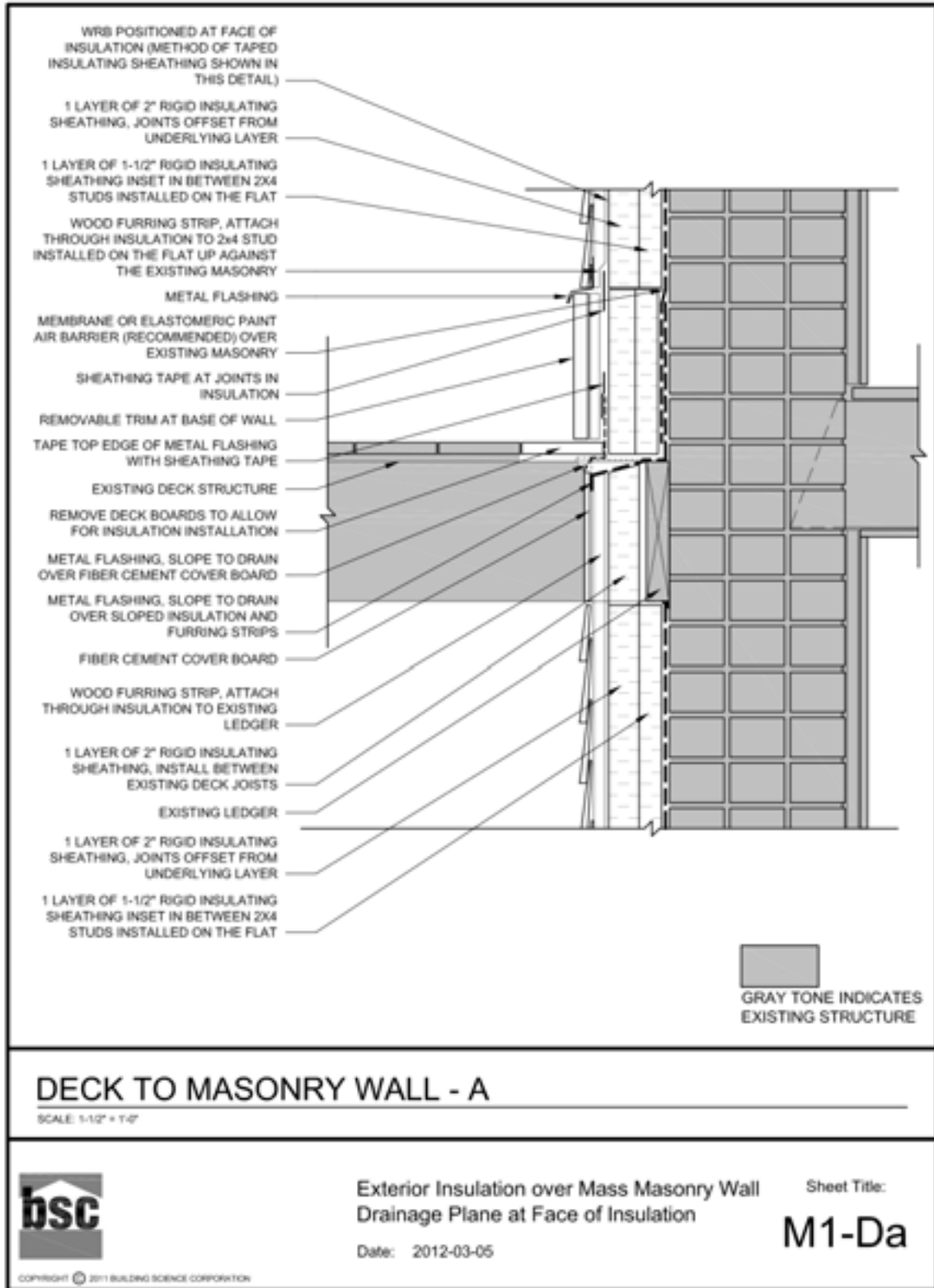

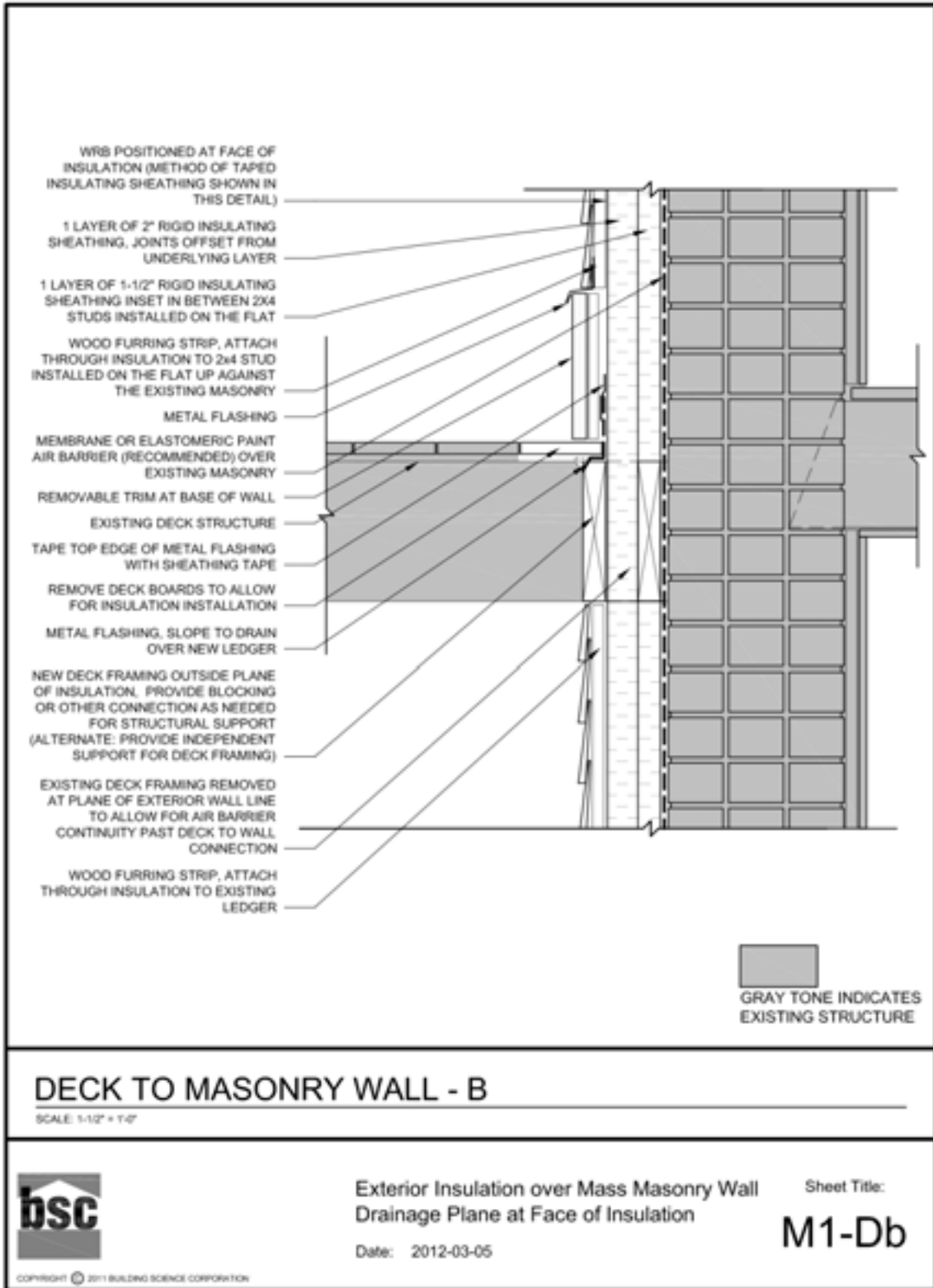

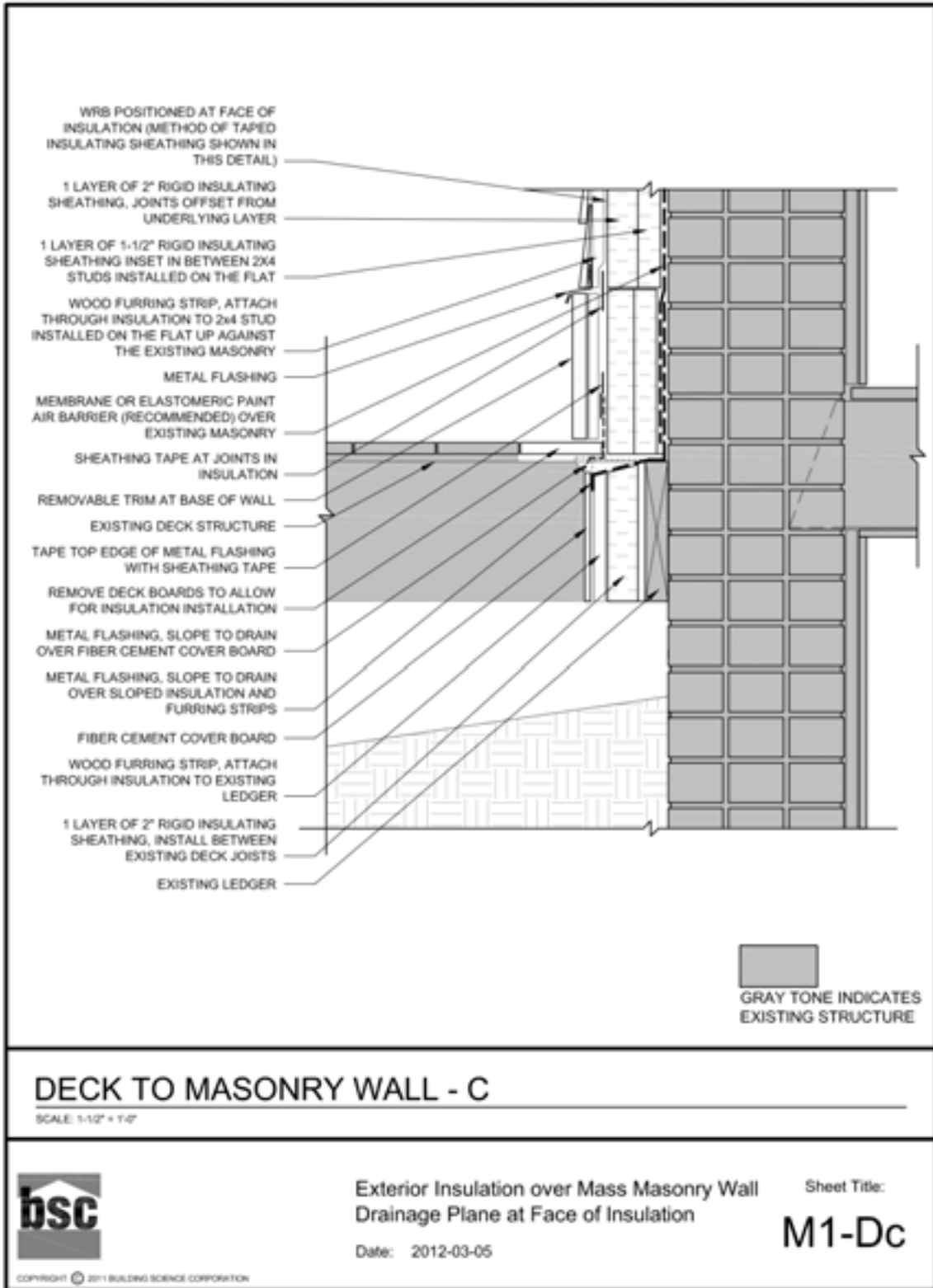

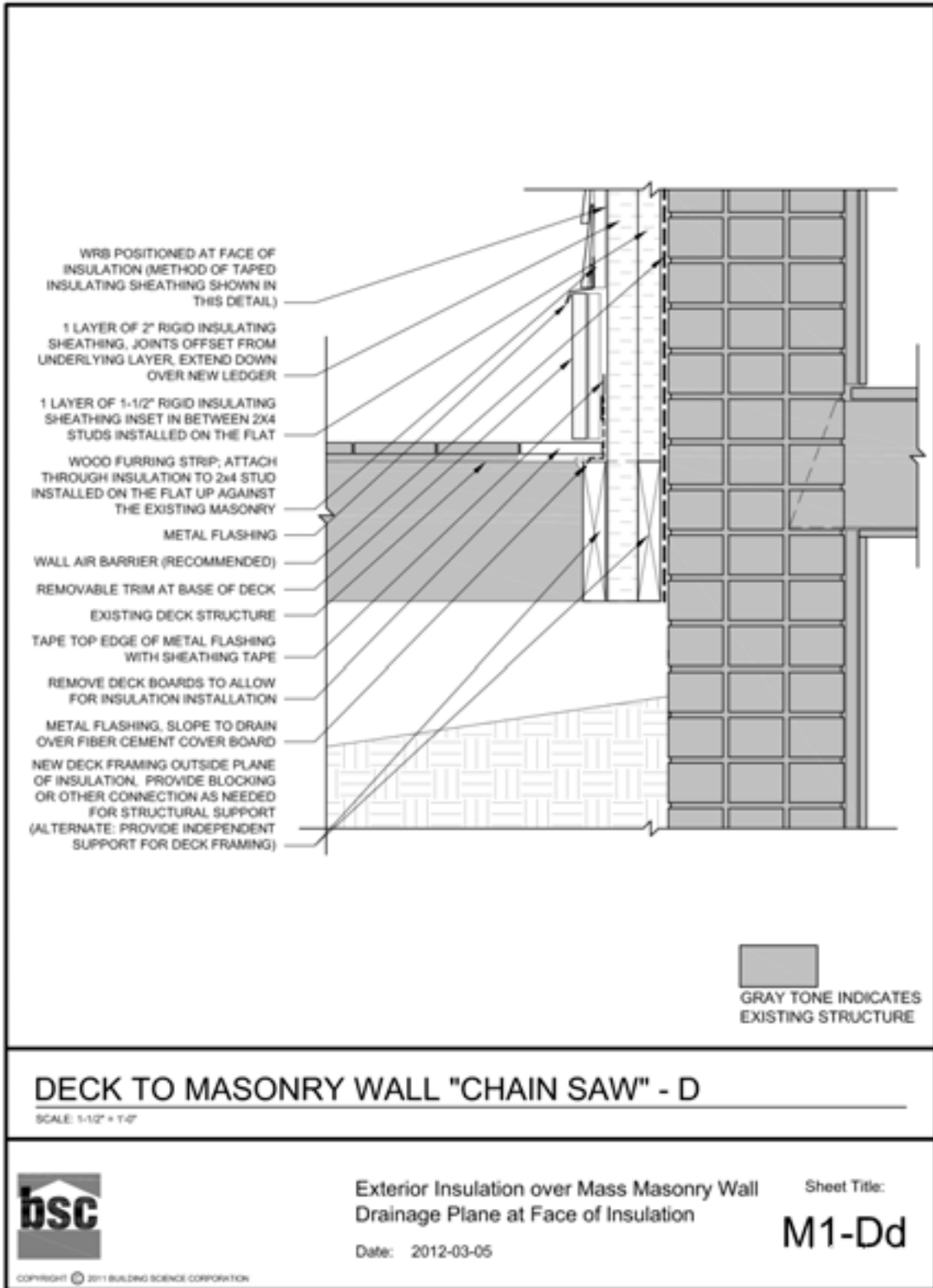

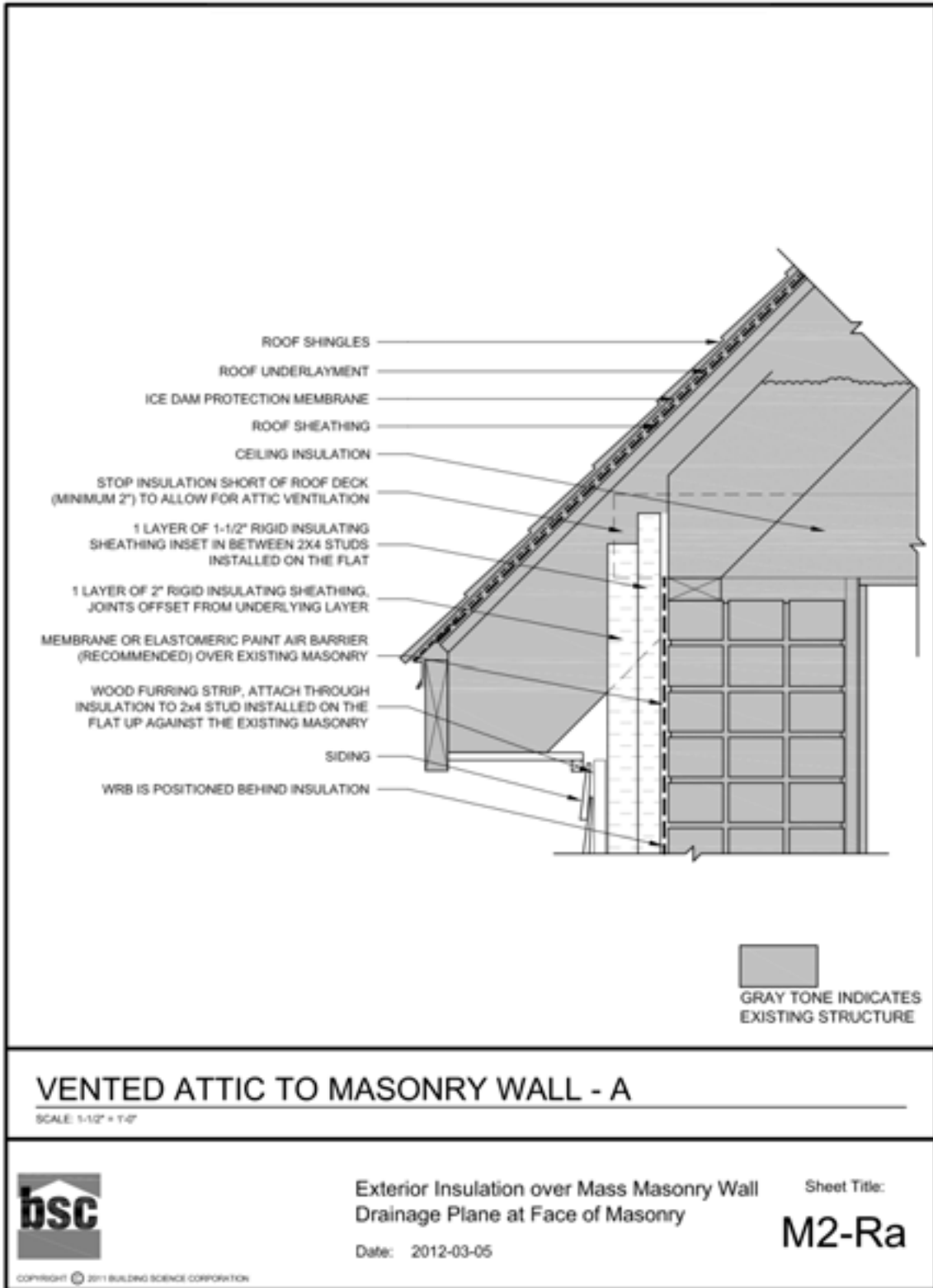

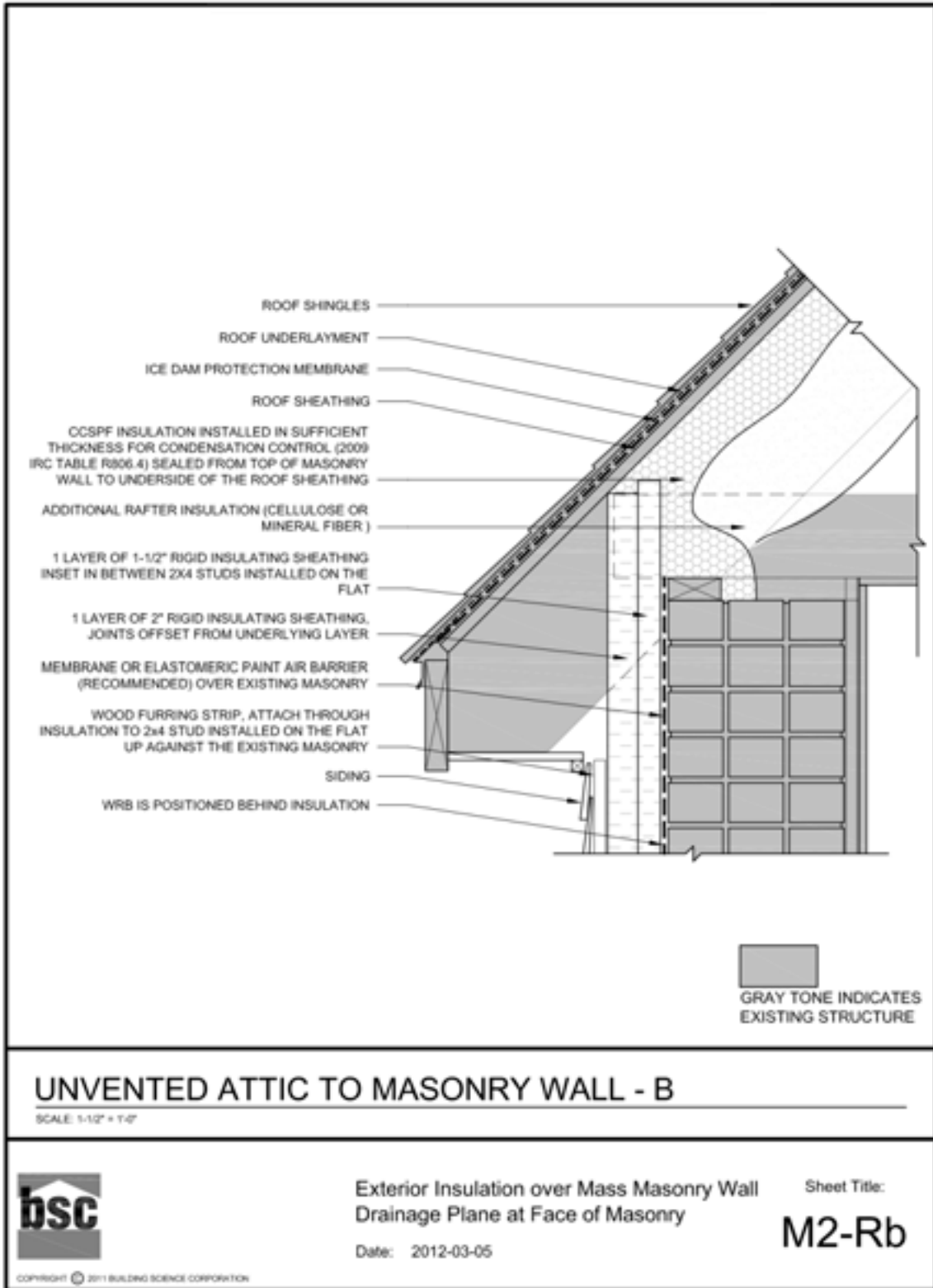

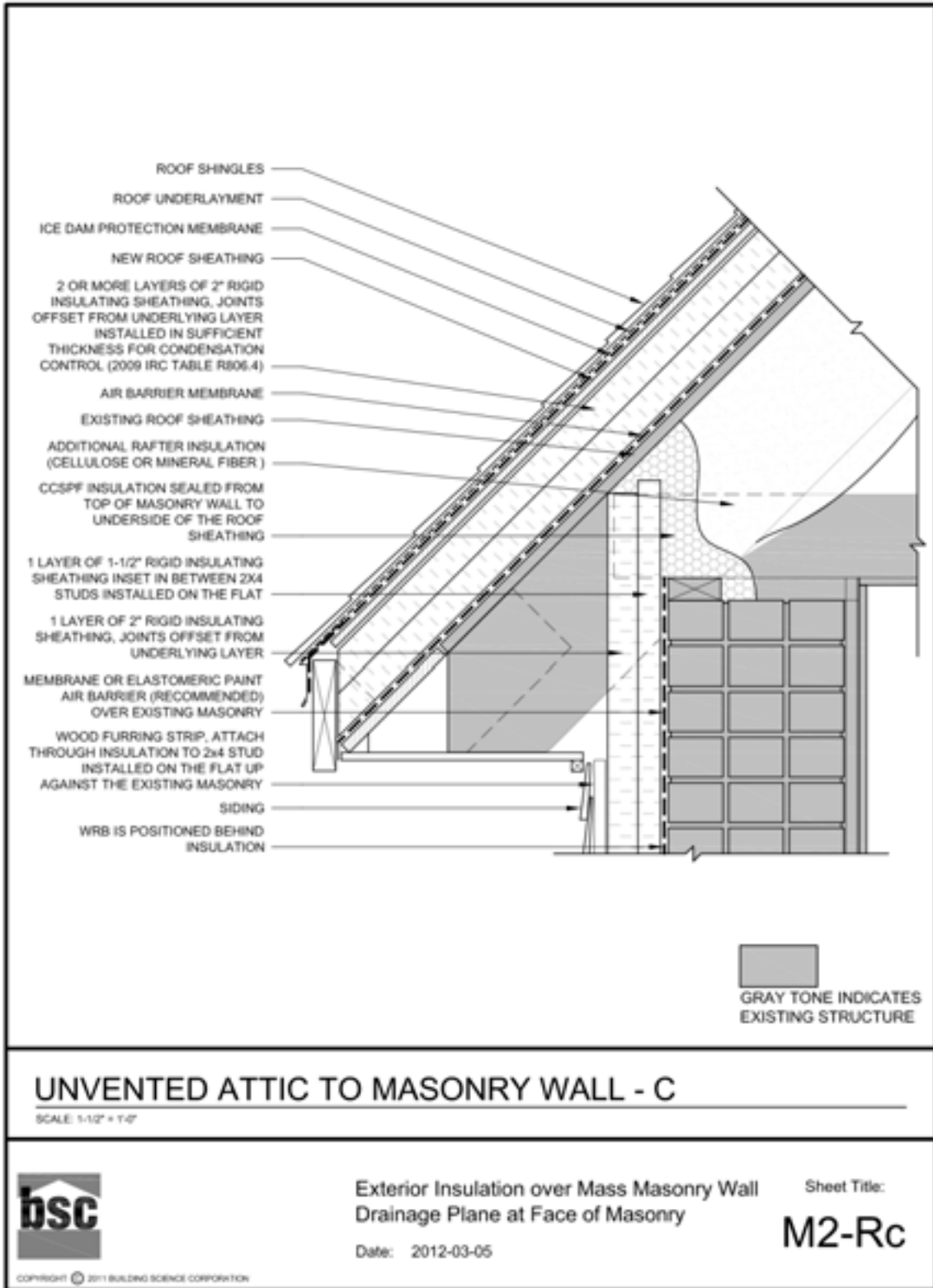

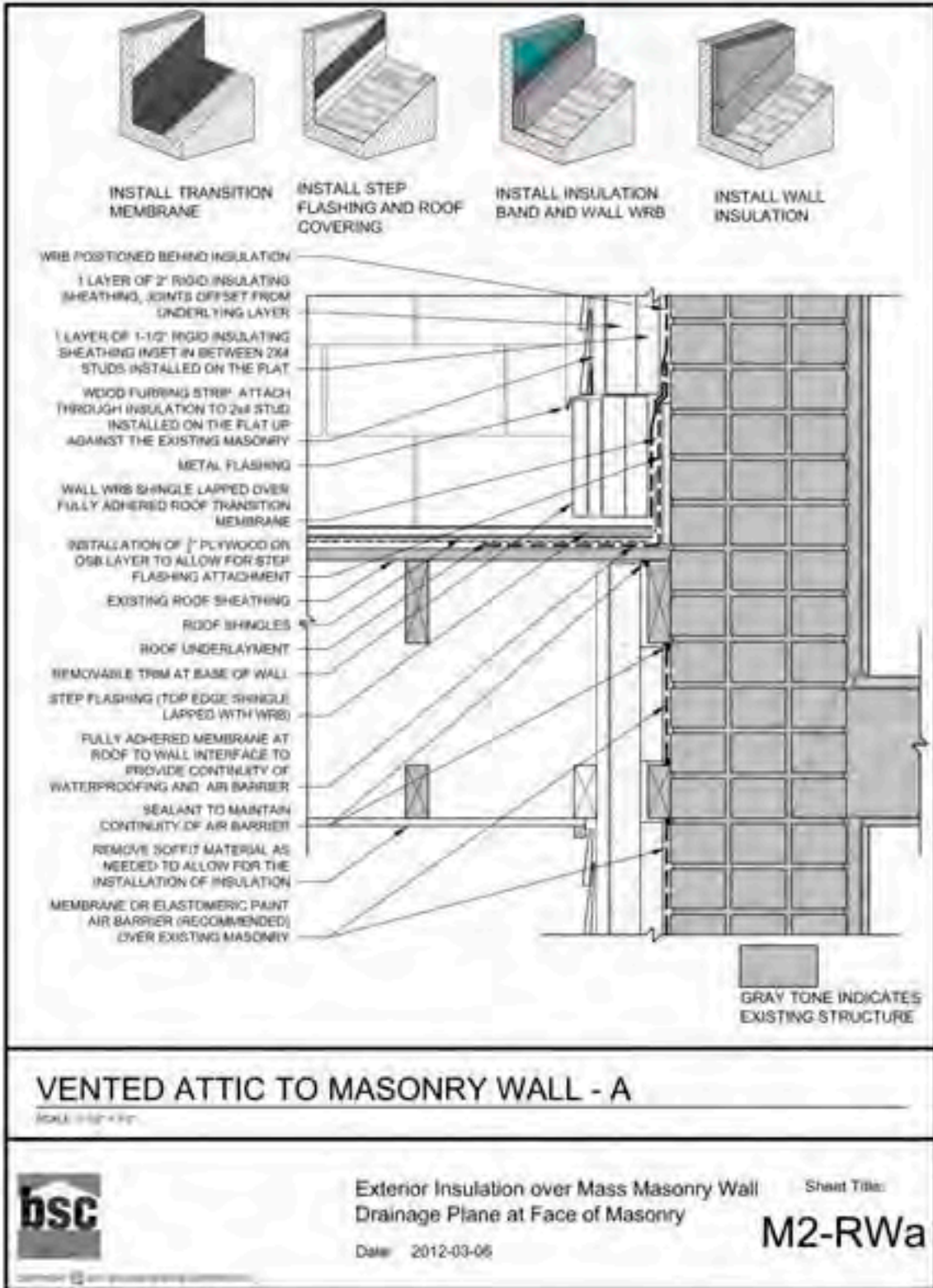

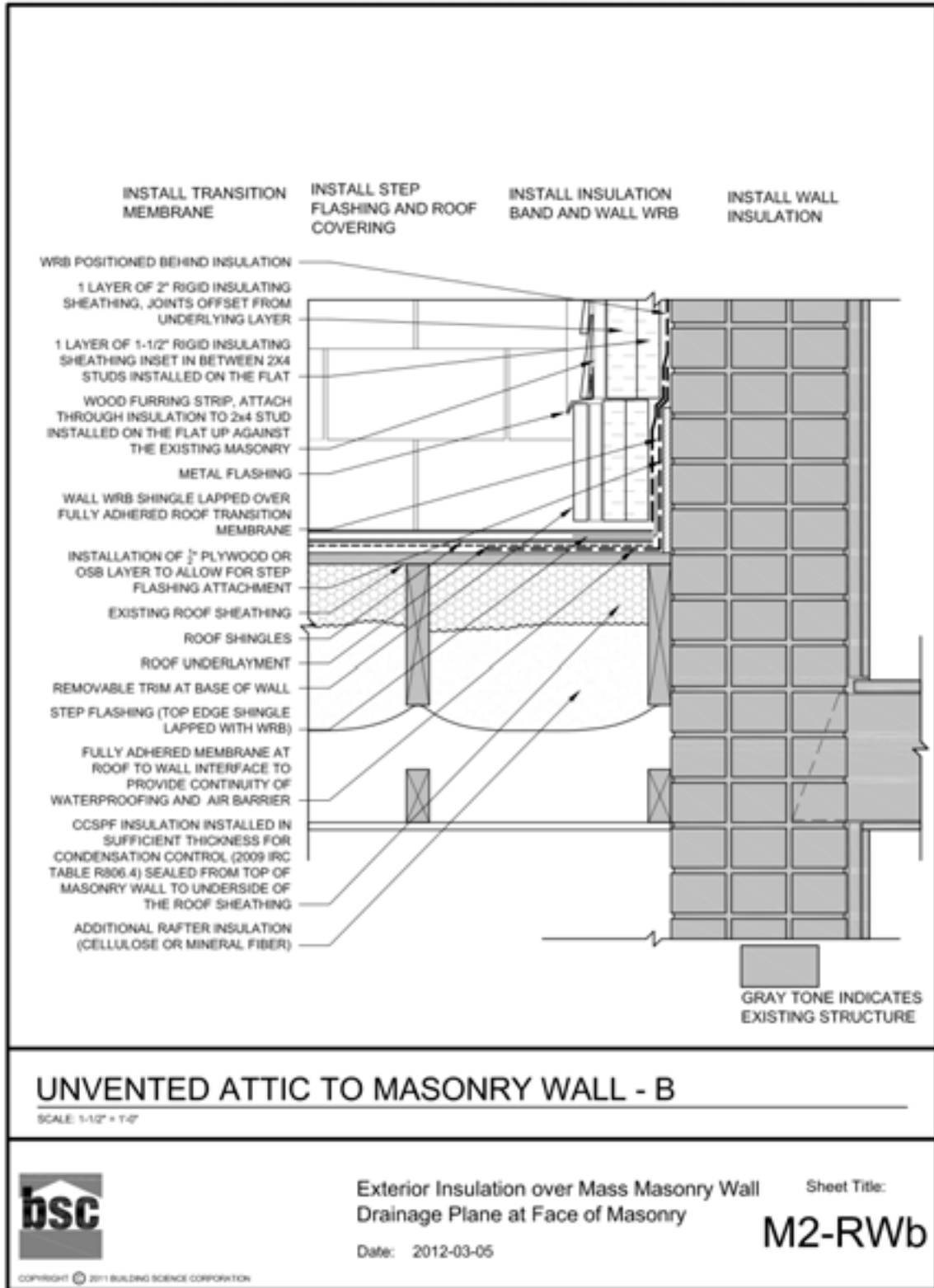

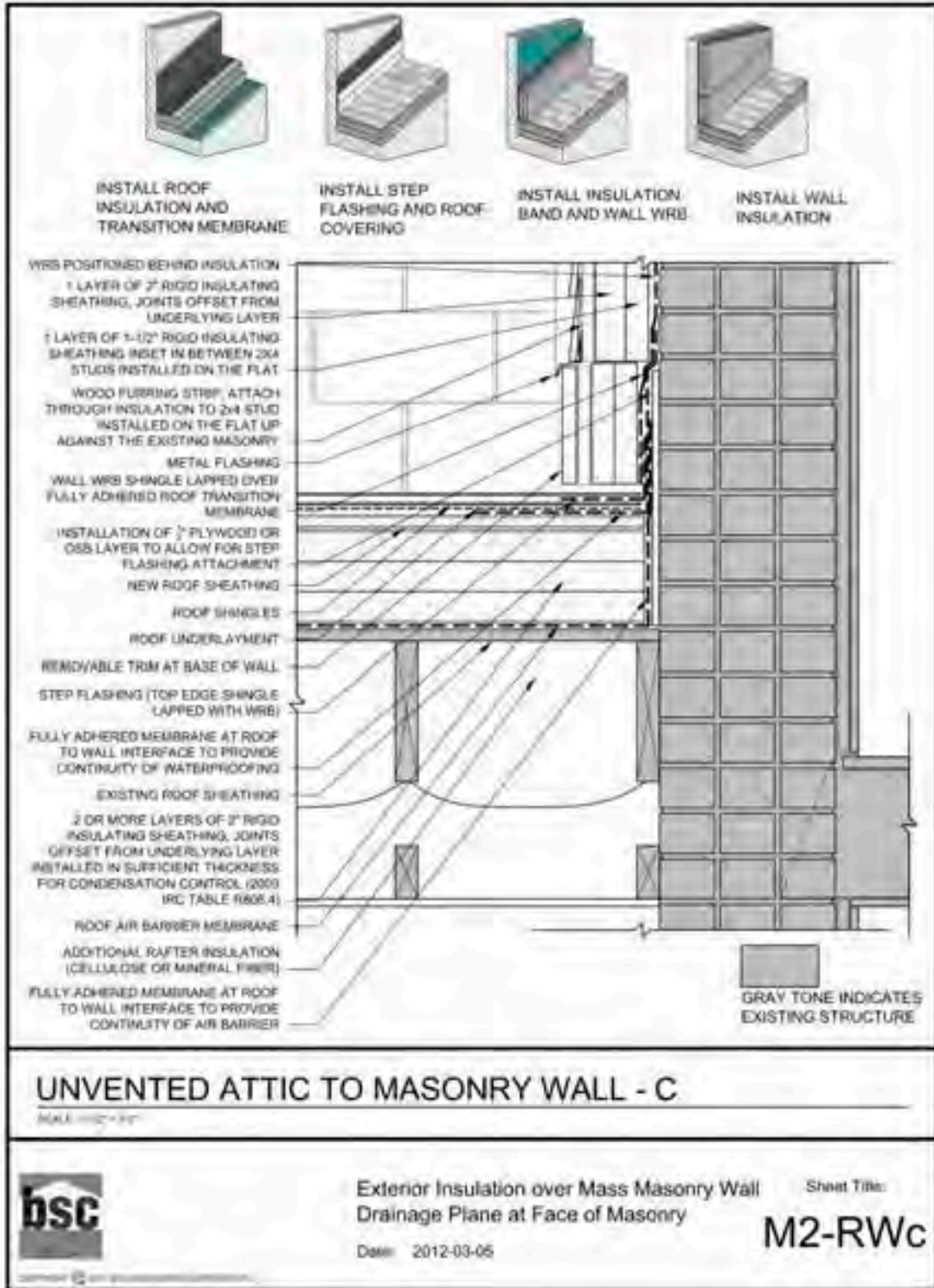

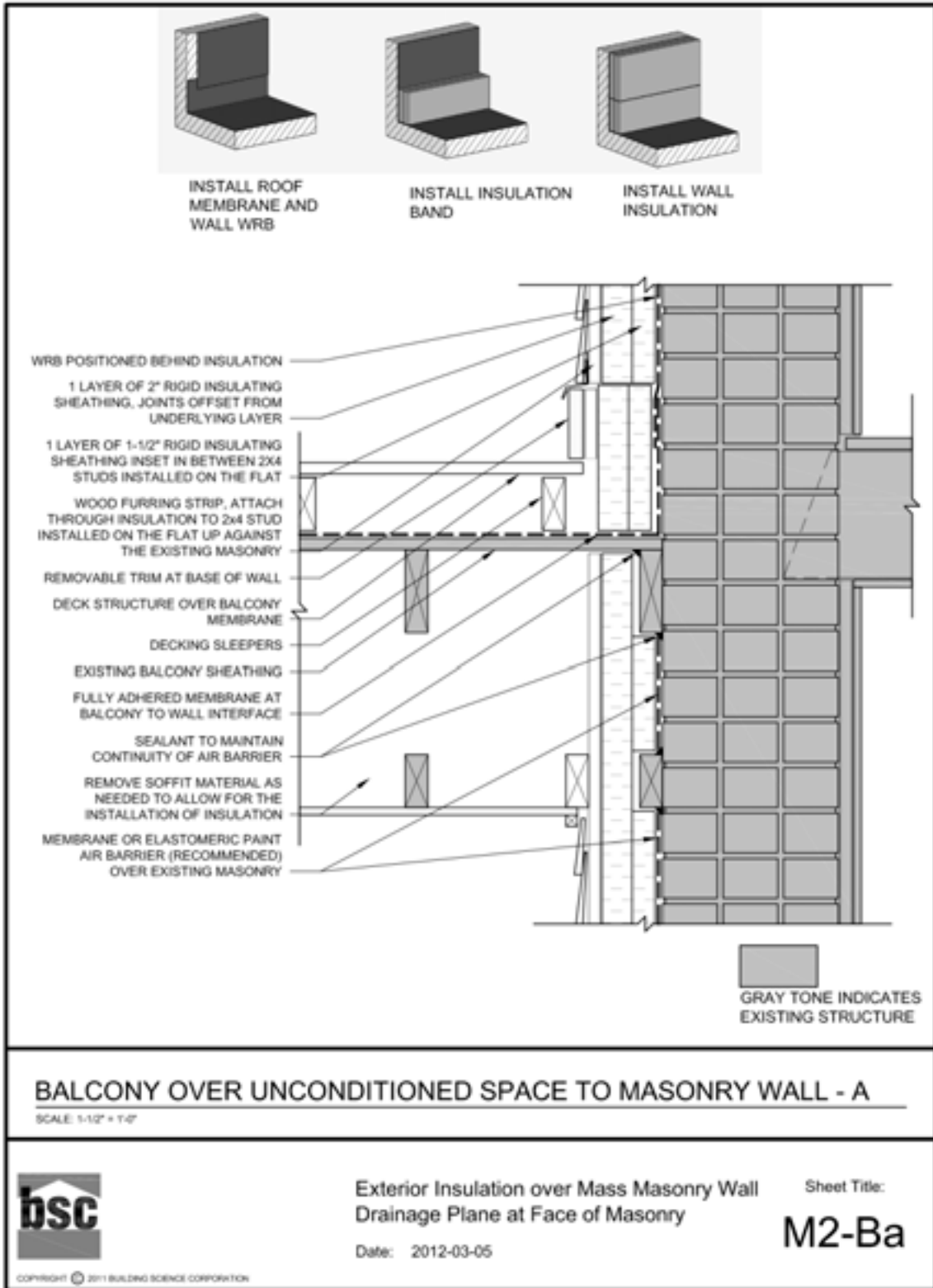

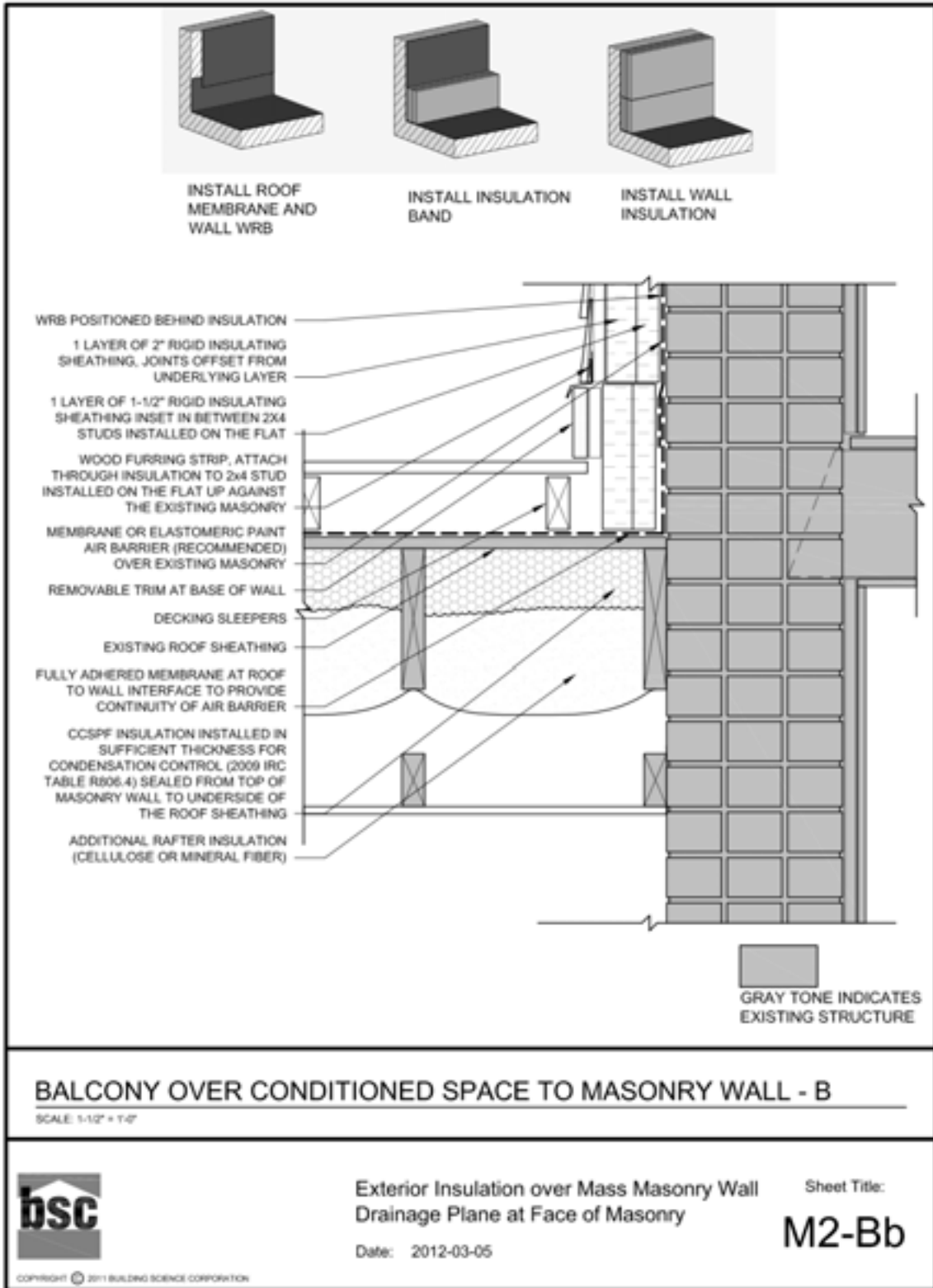

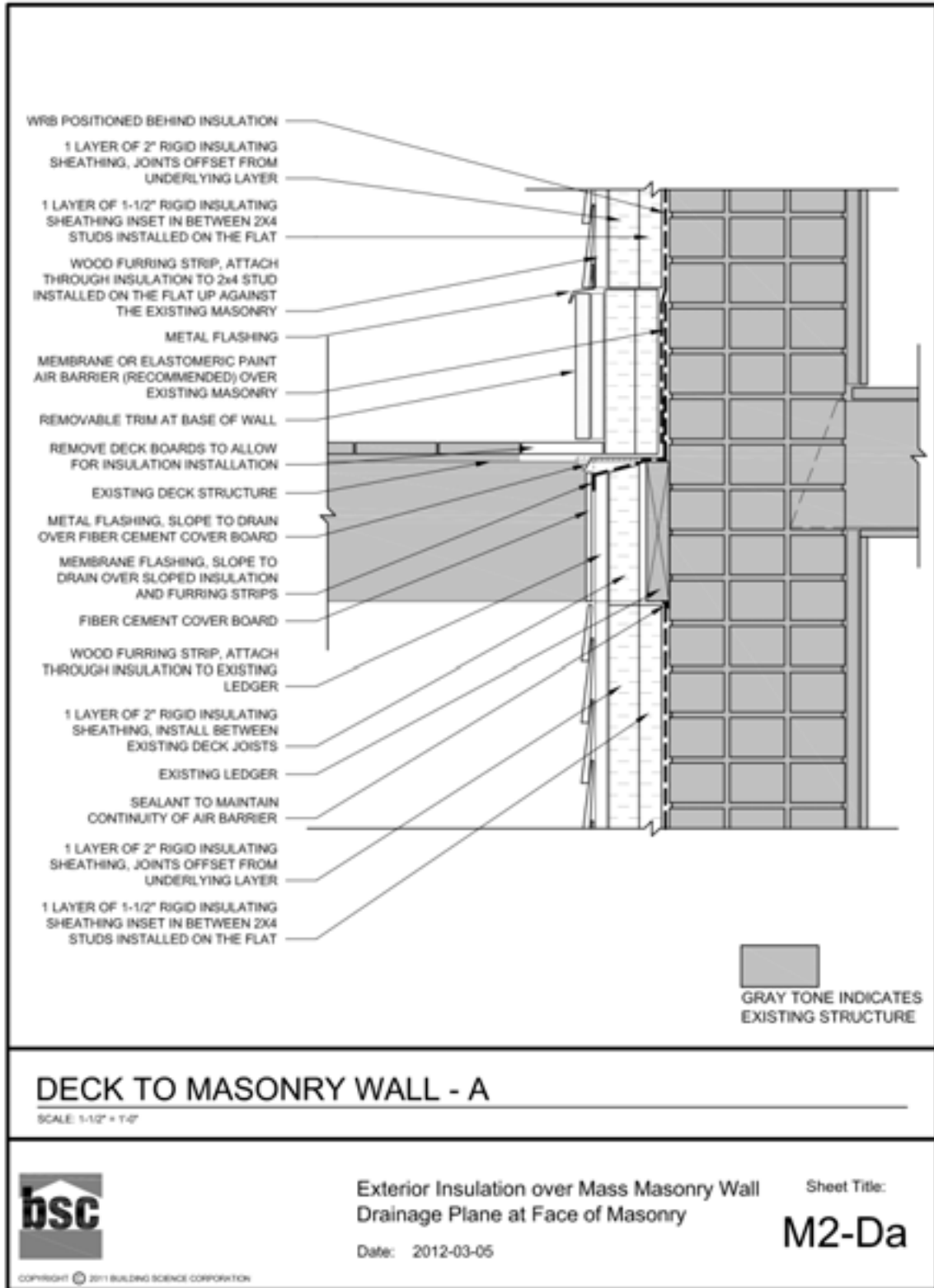

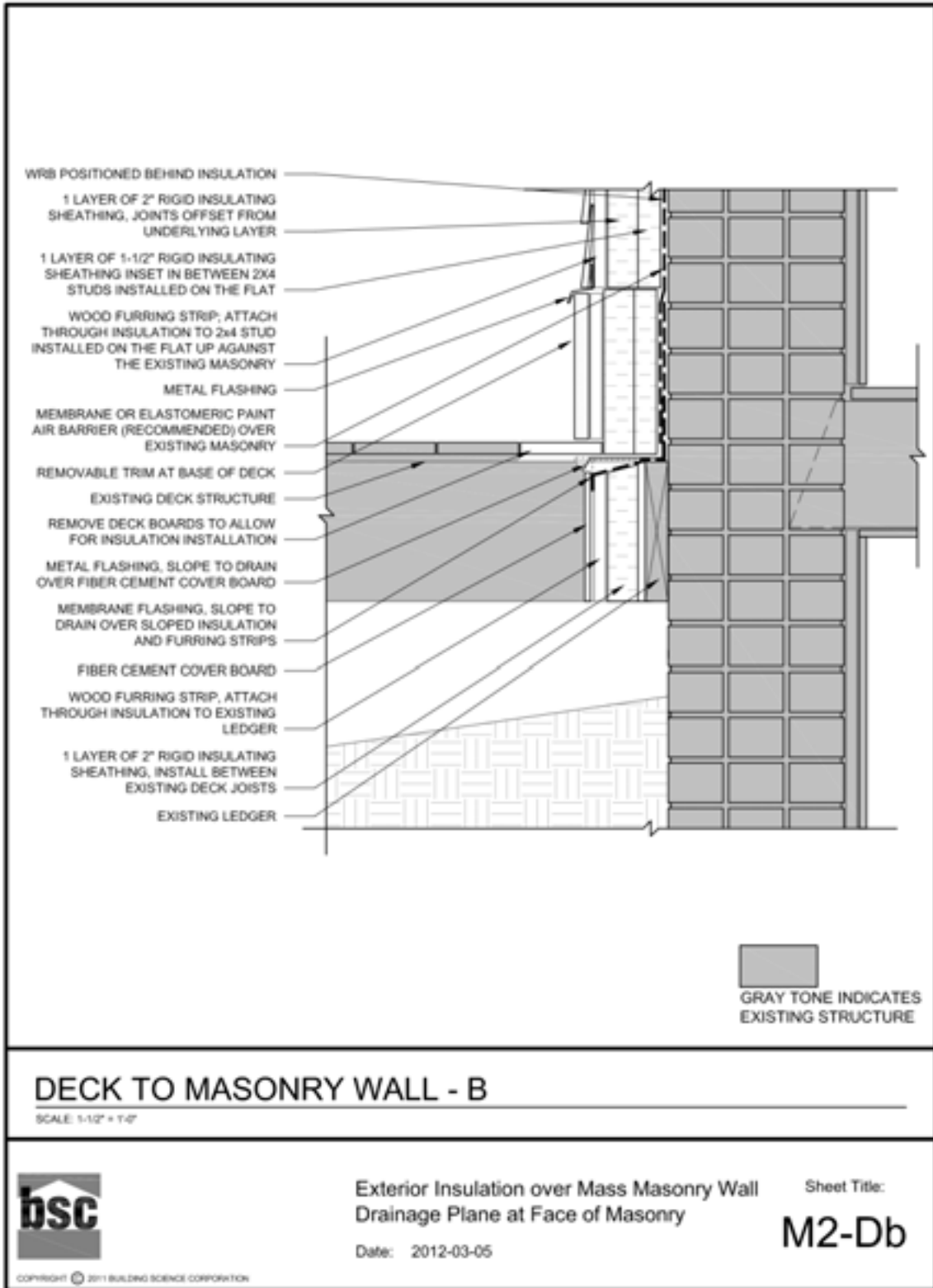

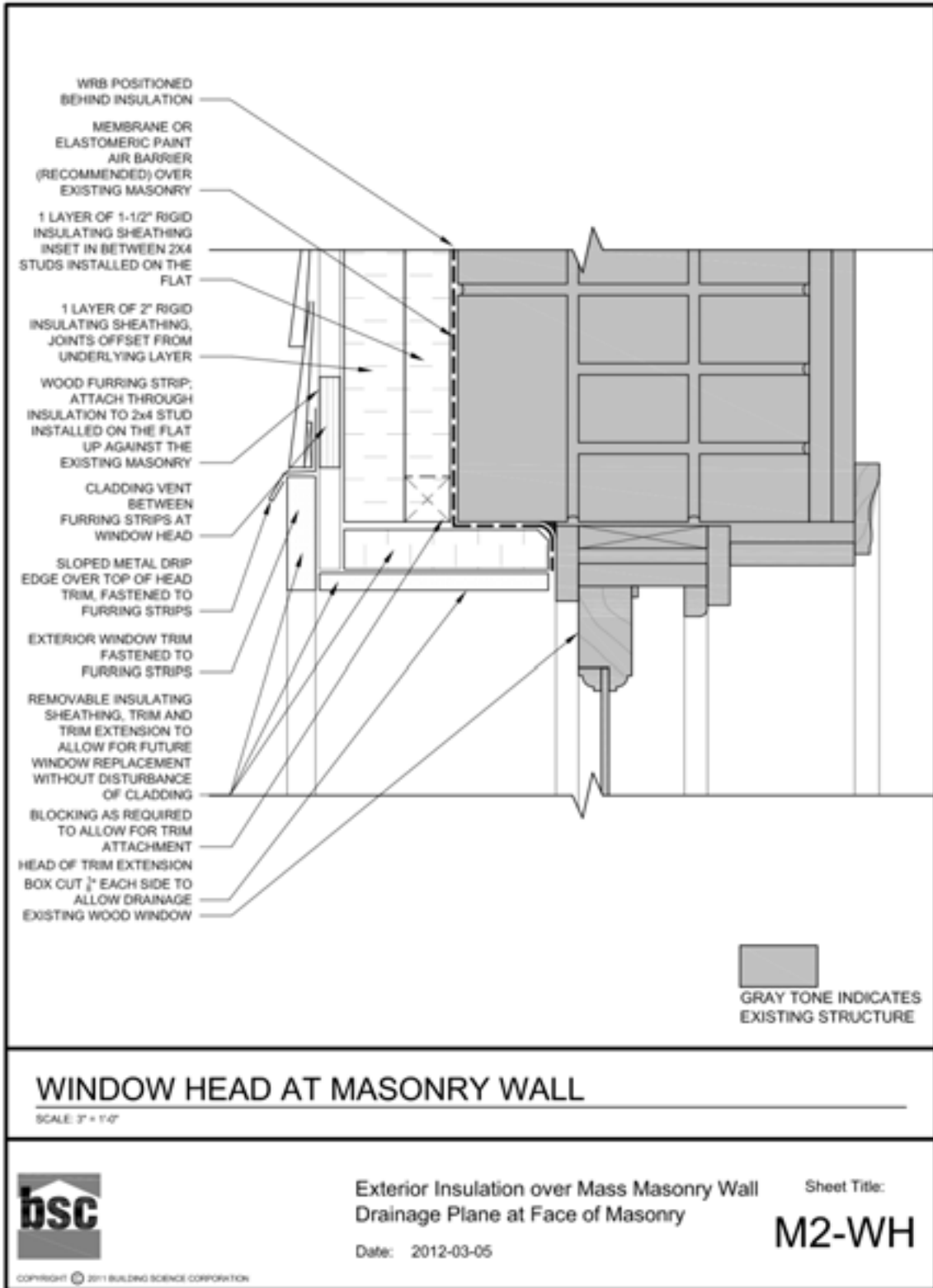

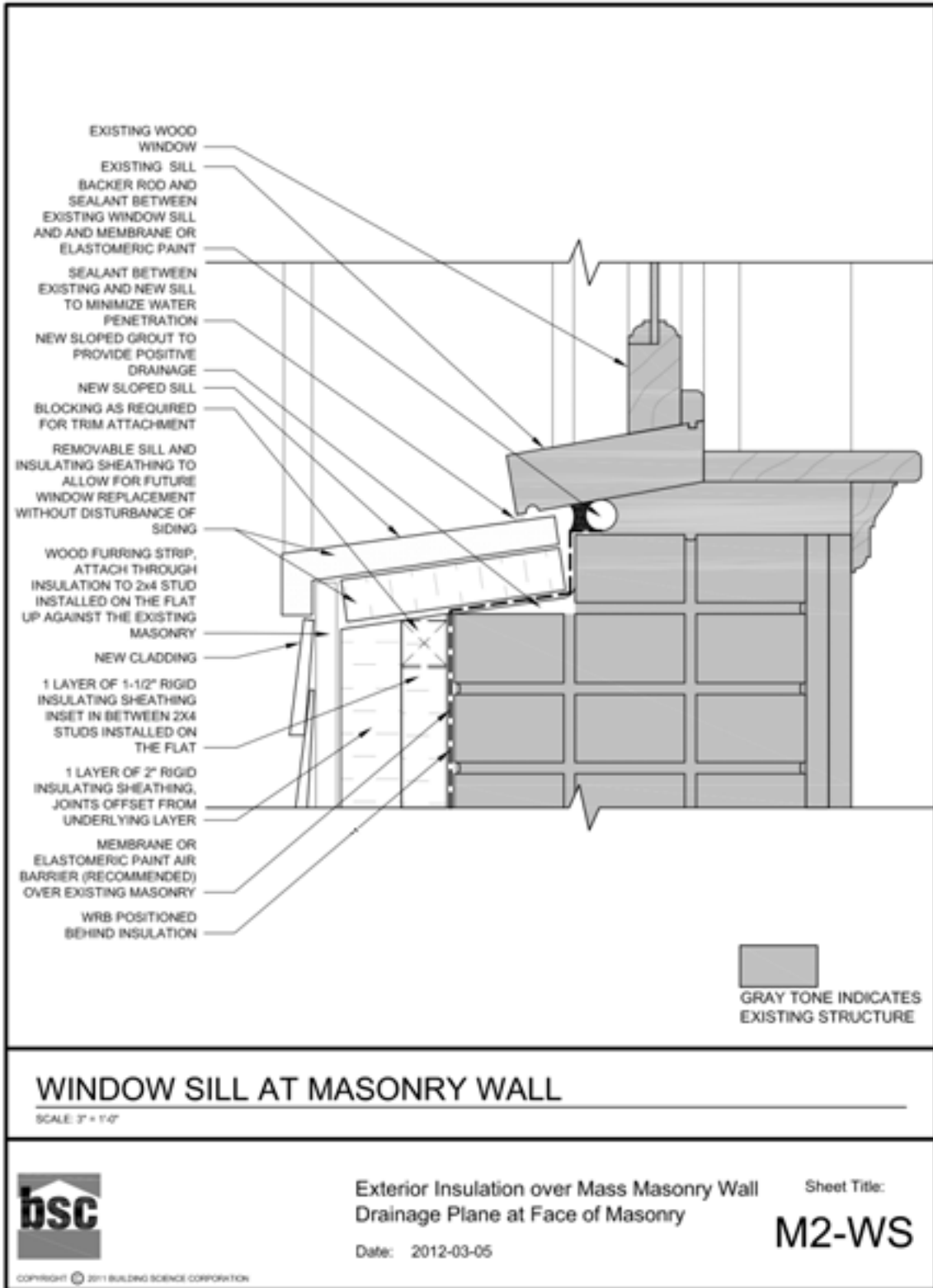

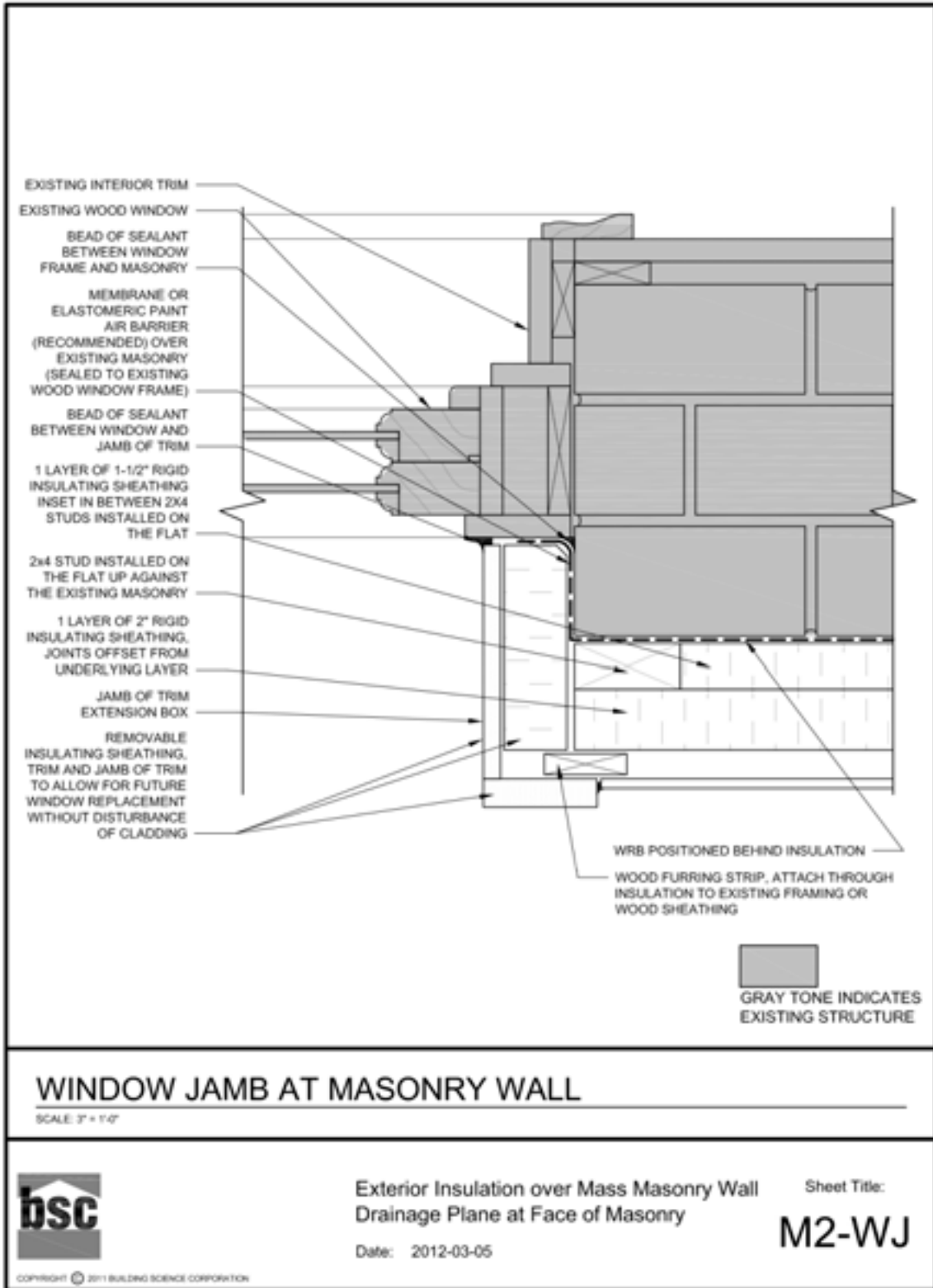

Appendix B: BEopt Simulation Graphs

B.1 Dallas, Texas

Utility Rates: \$0.13/kWh, \$1.09/therm

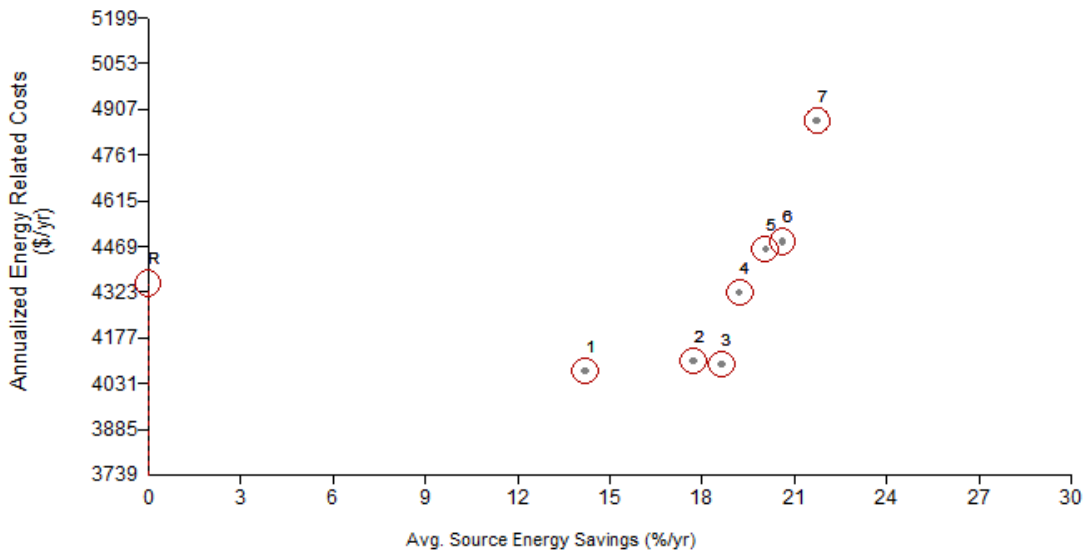

Figure 22. Annualized energy related costs versus average source energy savings for Dallas, Texas

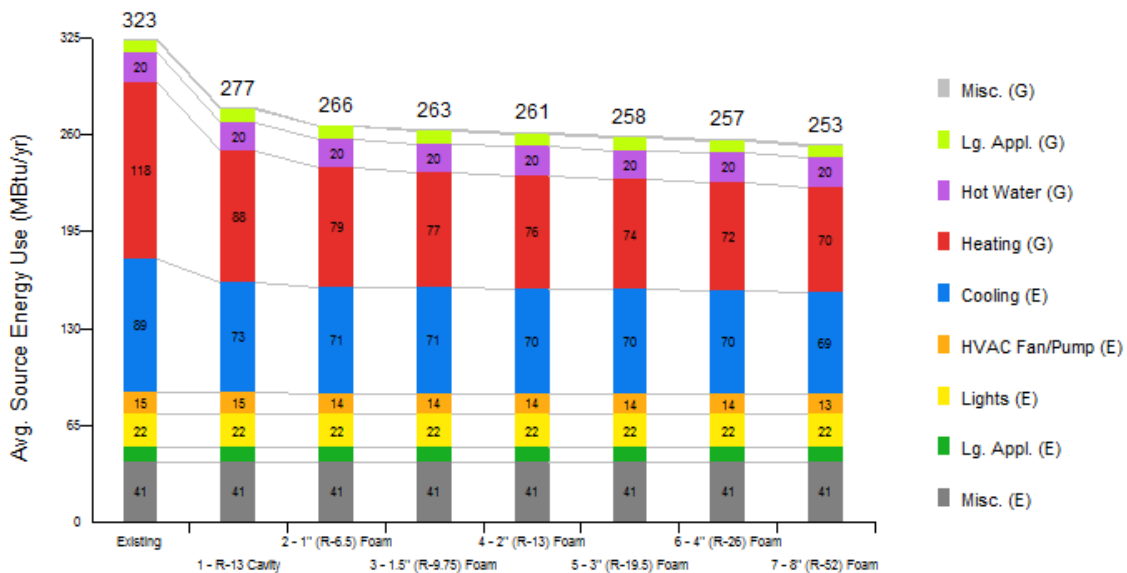

Figure 23. Average source energy savings reduction versus insulation level for Dallas, Texas

B.2 Kansas City, Missouri

Utility Rates: \$0.08/kWh, \$1.23/therm

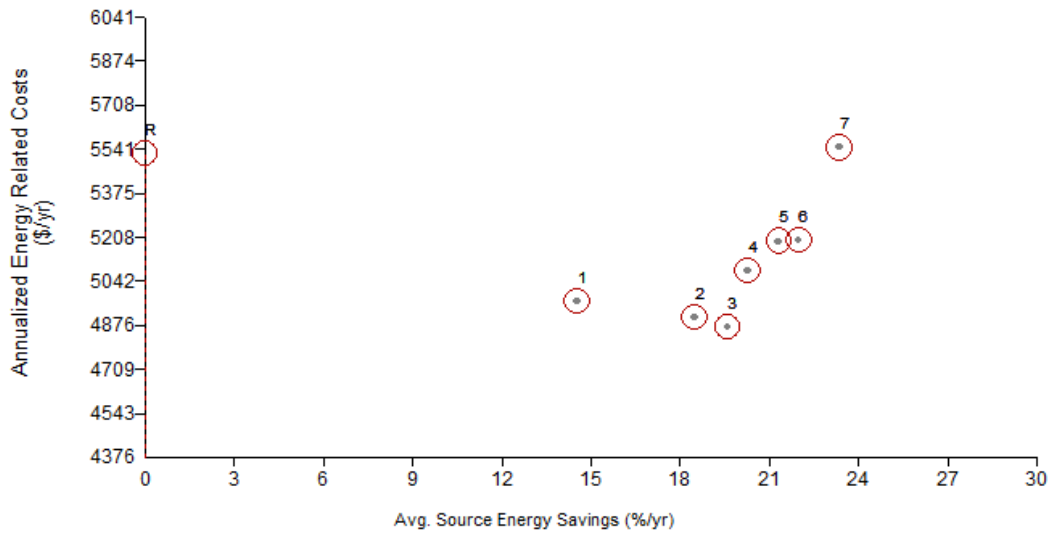

Figure 24. Annualized energy related costs versus average source energy savings for Kansas City, Missouri

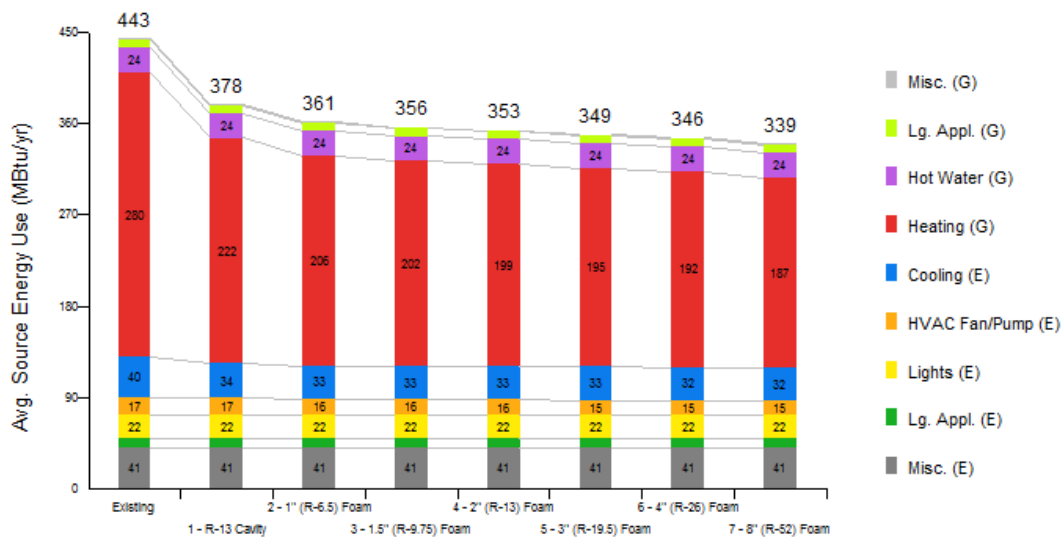

Figure 25. Average source energy savings reduction versus insulation level for Kansas City, Missouri

B.3 Boston, Massachusetts

Utility Rates: \$0.18/kWh, \$1.70/therm

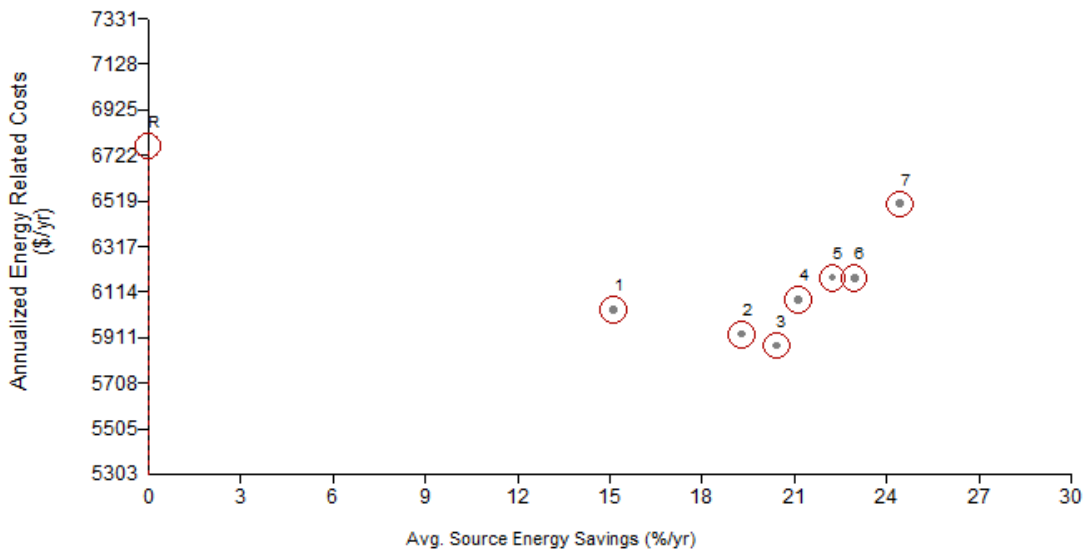

Figure 26. Annualized energy related costs versus average source energy savings for Boston, Massachusetts

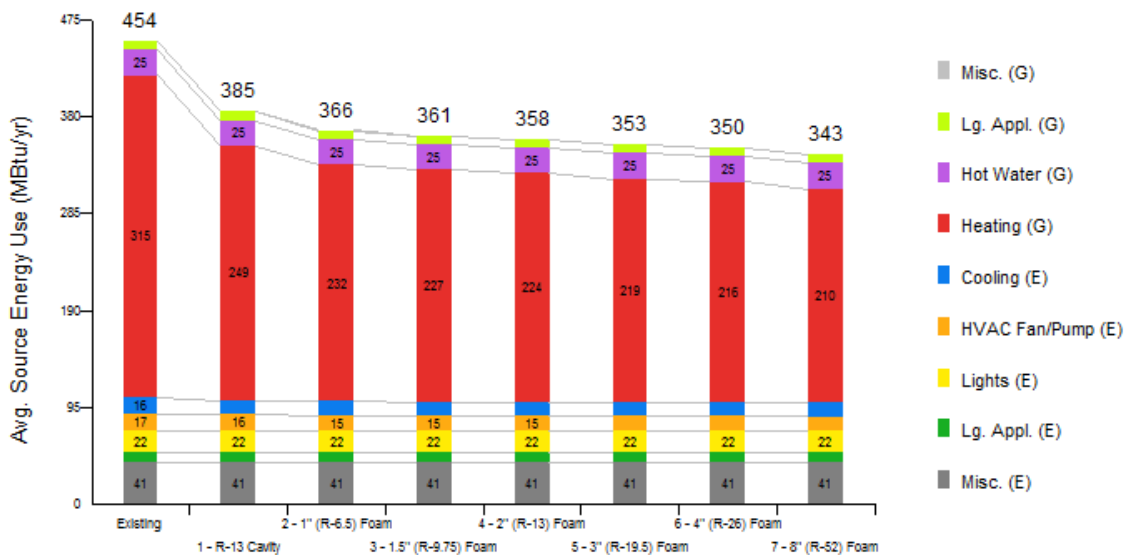

Figure 27. Average source energy savings reduction versus insulation level for Boston, Massachusetts

B.4 Duluth, Minnesota

Utility Rates: \$0.10/kWh, \$0.87/therm

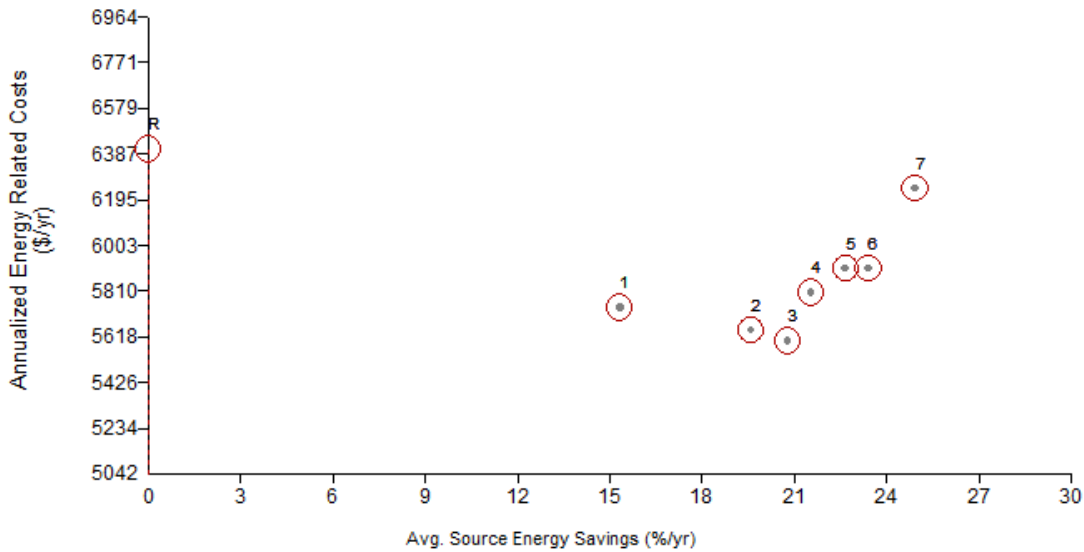

Figure 28. Annualized energy related costs versus average source energy savings for Duluth, Minnesota

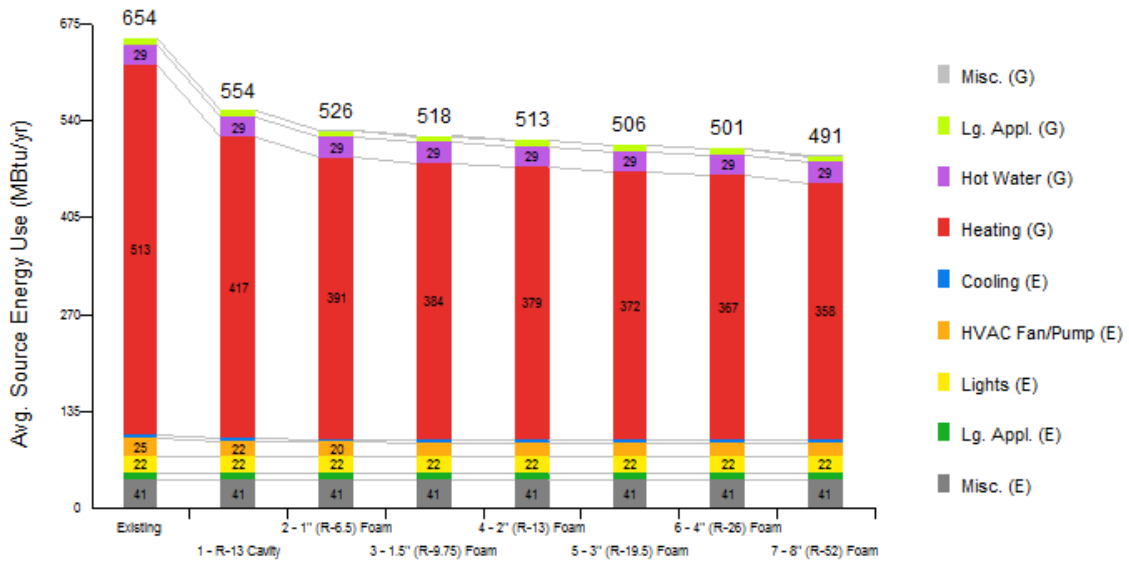

Figure 29. Average source energy savings reduction versus insulation level for Duluth, Minnesota

Appendix C: Short-Term Deflection Test Protocol

C.1 Support Structure

A wood framed wall was constructed and anchored to the concrete masonry unit (CMU) wall with metal brackets on the side and top to minimize movement of the framed wall relative to the CMU wall during testing. The wood framed wall is used to support the insulation and strapping for testing. The support frame consisted of 2 × 4 studs spaced at 24-in. o.c. and single top and bottom plates. Standard OSB sheathing was screwed into the frame. Plastic house wrap was installed to accurately represent the majority of enclosure wall systems in the field.

C.2 Insulation and Furring Strips

The insulation was installed in either two layers of 2-in. material or four layers of 2-in. material depending on which test was being conducted. The insulation was installed with horizontal joints offset between adjacent layers, and no vertical joints. The furring strips used for this testing were nominal 1 × 3 SPF. The screws were installed at 16-in. o.c. with dimension priority given to the bottom of the furring strip. The top screw was placed 1 in. below the top of the furring strip. A ratchet setting was used to ensure uniform compression forces along the furring strips, and the setting was noted in the test spreadsheet. The two furring strips were offset 9/16 in. below the insulation to avoid movement of the loading steel angle.

C.3 Measuring Devices

Using magnetic bases, 2¼-in. deflection gauges were installed on a steel bar attached to the concrete block wall. Two metal clips were installed near the bottom of each furring strip; these were installed for the gauge readings. Two gauges were used to measure the deflection of the left and right furring strips; the third measured the displacement of the OSB. Note that any rotational deflection of the furring strips may influence the dial gauge reading.

C.4 Loading Mechanism

The loading mechanism used was a hydraulic jack rated to 4,000 lb. A 1,000-lb load cell was connected to the top of the hydraulic jack; the load cell was connected to a digital reader to convert voltage into mass readings. A 2.5 × 2.5 steel angle was used to transfer the load to the two furring strips. To avoid the steel angle hitting the wall, the furring strips were installed 0.5 in. below the bottom of the supporting wall.

C.5 Testing Procedure

The following procedure assumes that the framing, sheathing, and sheathing membrane have already been installed:

Install the support shelf using the ½-in. plywood spacers. The plywood spacers ensure that the insulation is installed flush with the bottom of the framed test wall, and that the furring strips are installed ½ in. below the edge of the insulation. Align the furring strips with the framing and install one screw near the bottom. Align the top of the furring strip with the stud marking at the top of the test wall, and finish installing the screws into the furring strip from the bottom to the top, inserting the insulation between the sheathing membrane and furring strip as required.

Install the angle using two small wood screws to hold it in place temporarily. Ensure that the angle is spaced evenly between the two furring strips, so that the push point for the hydraulic ram is equidistant from each furring strip. Install the dial gauges and ensure that they are all vertical. Install the two angles used as measurement points for the dial gauges near the bottom of each furring strip, and ensure that they are level. Place the hydraulic jack in the center and ensure that it is vertical. There is a concave point on the metal angle in which the end of the hydraulic ram rests.

Apply a small load to the hydraulic ram (~40 lb) and remove the screws that were used to temporarily hold the metal angle in place. Previous testing showed that keeping this metal angle screwed in place did affect the readings.

The amount of load applied to the furring strips is dependent on the test method. For the first series of Building America short-term deflection tests, some hysteresis analysis was conducted by applying various loads, and then releasing the load. If hysteresis measurements are taken, the hydraulic ram should only be unloaded to approximately 20 lb ($<1 \text{ lb/ft}^2$) so that the metal angle does not fall off the ram.

For the original set of 4-in. Building America short-term deflection testing, the testing protocol was as follows:

1. Load wall to 120 lb (4 lb/ft^2)
2. Unload wall to ~20 lb
3. Load wall to 360 lb (11 lb/ft^2)
4. Unload wall to ~20 lb
5. Load wall to 500 lb (16 lb/ft^2)
6. Unload wall to ~20 lb
7. Load wall to 750 lb (23 lb/ft^2)
8. Unload wall to ~20 lb
9. Load wall to 1,000 lb (31 lb/ft^2)

To unload the wall, especially at high loads, unscrew the release valve very slowly because the load will drop very quickly. Make any notes as required in the Excel template for data collection and analysis.

Appendix D: Long-Term Deflection Test Protocol

D.1 Support Structure

A wood framed wall was constructed and anchored to the CMU wall with metal brackets on the side and top to minimize movement of the framed wall relative to the CMU wall during testing. The wood framed wall was used to support the insulation and strapping for testing. The support frame consisted of a single 2 × 6 stud with a single top and bottom plate. Sixteen-inch-wide standard OSB sheathing was screwed into the frame. Plastic house wrap was installed to accurately represent the majority of enclosure wall systems in the field.

D.2 Insulation and Furring Strips

The insulation was installed in two layers of 2 in. (16-in. wide). The insulation was installed with horizontal joints offset between adjacent layers, and no vertical joints. A single 1 × 3 furring strip was installed in the center of the insulation. The furring strips used for this testing were nominal 1 × 3 SPF. The screws were installed at 16-in. o.c. with dimension priority given to the bottom of the furring strip. The top screw was placed 1 in. below the top of the furring strip.

D.3 Measuring Devices

A reinforced metal angle was attached to the back of the OSB so that the horizontal leg of the angle extended past the front surface of the insulation. A deflection gauge was attached to a wood block securely fastened to the bottom of the strapping so that the needle on the deflection gauge rested on the metal horizontal leg of the metal angle. As the strapping deflected, the metal angle remained stationary relative to the OSB sheathing, and the deflection of the strapping relative to the OSB was measured.

D.4 Loading Mechanism

For the long-term testing, weight was hung from a bracket securely fastened to the outside surface of the strapping so that the load is carried in the same position as it would be if cladding were attached to the strapping. To simulate cladding weight, buckets were three-quarters filled with concrete. The remainder of each bucket was filled with gravel so that the total added weight was approximately 213 lb (20 lb/ft²). These buckets were attached to the bracket with chain, and then slowly lowered to a hanging position using a hydraulic automotive jack.

Four of the test walls were loaded to 20 psf, and a fifth comparison wall was loaded to 50 psf.

D.5 Testing Procedure

The first reading was taken at the 30-s mark, which captured the immediate initial deflection once the weight was added. Several more readings were recorded during the first day to capture any deflection curve, should one exist, and then daily readings were taken Monday through Friday until the testing was complete.

buildingamerica.gov

U.S. DEPARTMENT OF
ENERGY | Energy Efficiency &
Renewable Energy

DOE/GO-102013-3571 • January 2013

Printed with a renewable-source ink on paper containing at least 50% wastepaper, including 10% post-consumer waste.

BA-1204: External Insulation of Masonry Walls and Wood Framed Walls

About this Report

This report was prepared with the cooperation of the U.S. Department of Energy's Building America Program.

About the Author

Peter Baker is a Senior Associate at Building Science Corporation.

Direct all correspondence to: Building Science Corporation, 30 Forest Street, Somerville, MA 02143.

Limits of Liability and Disclaimer of Warranty:

Building Science documents are intended for professionals. The author and the publisher of this article have used their best efforts to provide accurate and authoritative information in regard to the subject matter covered. The author and publisher make no warranty of any kind, expressed or implied, with regard to the information contained in this article.

The information presented in this article must be used with care by professionals who understand the implications of what they are doing. If professional advice or other expert assistance is required, the services of a competent professional shall be sought. The author and publisher shall not be liable in the event of incidental or consequential damages in connection with, or arising from, the use of the information contained within this Building Science document.

NOTICE

This report was prepared as an account of work sponsored by an agency of the United States government. Neither the United States government nor any agency thereof, nor any of their employees, subcontractors, or affiliated partners makes any warranty, express or implied, or assumes any legal liability or responsibility for the accuracy, completeness, or usefulness of any information, apparatus, product, or process disclosed, or represents that its use would not infringe privately owned rights. Reference herein to any specific commercial product, process, or service by trade name, trademark, manufacturer, or otherwise does not necessarily constitute or imply its endorsement, recommendation, or favoring by the United States government or any agency thereof. The views and opinions of authors expressed herein do not necessarily state or reflect those of the United States government or any agency thereof.

Available electronically at <http://www.osti.gov/bridge>

Available for a processing fee to U.S. Department of Energy
and its contractors, in paper, from:

U.S. Department of Energy
Office of Scientific and Technical Information
P.O. Box 62
Oak Ridge, TN 37831-0062
phone: 865.576.8401
fax: 865.576.5728

email: <mailto:reports@adonis.osti.gov>

Available for sale to the public, in paper, from:

U.S. Department of Commerce
National Technical Information Service
5285 Port Royal Road
Springfield, VA 22161
phone: 800.553.6847
fax: 703.605.6900

email: orders@ntis.fedworld.gov

online ordering: <http://www.ntis.gov/ordering.htm>



External Insulation of Masonry Walls and Wood Framed Walls

Prepared for:

The National Renewable Energy Laboratory

On behalf of the U.S. Department of Energy's Building America Program

Office of Energy Efficiency and Renewable Energy

15013 Denver West Parkway

Golden, CO 80401

NREL Contract No. DE-AC36-08GO28308

Prepared by:

P. Baker

Building Science Corporation

30 Forest Street

Somerville, MA 02143

NREL Technical Monitor: Cheryn Metzger

Prepared under Subcontract No. KNDJ-0-40337-00

January 2013

Contents

List of Figures	vi
List of Tables	vii
Definitions.....	viii
Executive Summary	ix
1 Problem Statement.....	1
1.1 Introduction.....	1
1.2 Background.....	1
1.3 Cost Effectiveness.....	2
1.4 Other Benefits.....	4
2 Cladding Attachment Design	5
2.1 Previous Research.....	6
2.2 Wind Load Resistance	8
2.3 Gravity Load Resistance	10
3 Water Management Details	24
3.1 Exterior Insulation Materials	26
3.2 Water Resistive Barrier.....	27
3.3 Air Barrier.....	28
3.4 Cladding Attachment	28
3.5 Window Integration	29
3.6 Roof Integration.....	31
3.7 Balcony Integration.....	37
3.8 Deck Integration	37
4 Conclusions	38
References.....	40
Appendix A: Water Management Details	41
Appendix B: BEopt Simulation Graphs	107
B.1 Dallas, Texas.....	107
B.2 Kansas City, Missouri.....	108
B.3 Boston, Massachusetts.....	109
B.4 Duluth, Minnesota	110
Appendix C: Short-Term Deflection Test Protocol.....	111
C.1 Support Structure	111
C.2 Insulation and Furring Strips	111
C.3 Measuring Devices.....	111
C.4 Loading Mechanism	111
C.5 Testing Procedure	111
Appendix D: Long-Term Deflection Test Protocol	113
D.1 Support Structure	113
D.2 Insulation and Furring Strips	113
D.3 Measuring Devices.....	113
D.4 Loading Mechanism	113
D.5 Testing Procedure	113

List of Figures

Figure 1. Recommended cladding attachment design	5
Figure 2. Table 8 excerpt from Crandell (2010)	7
Figure 3. Example of fastener yielding in Mode IV	12
Figure 4. Short-term deflection test panel.....	14
Figure 5. Example hysteresis test plot for short-term deflection testing	15
Figure 6. Long-term deflection test panel	16
Figure 7. Dead weights attached to bottom edge of furring strips	17
Figure 8. Short-term deflection testing results (4-in.-thick insulation)	18
Figure 9. Short-term deflection testing results (8-in.-thick insulation)	18
Figure 10. Forces providing vertical displacement resistance	19
Figure 11. Deflection of furring strips under sustained load	21
Figure 12. Typical exterior retrofit detail, showing furring strip cladding attachment.....	25
Figure 13. Layering patterns of exterior insulation	26
Figure 14. WRB options with exterior insulation.....	27
Figure 15. Recommended air barrier location for retrofit assemblies	28
Figure 16. Recommended cladding attachment design	29
Figure 17. Detail of masonry sill removal to allow for insulation to return to the window frame.....	31
Figure 18. Common roof to wall connections	31
Figure 19. Different drainage plane placement for exterior insulation retrofits	32
Figure 20. Roof to wall interface with WRB behind the insulation	34
Figure 21. Roof to wall interface with WRB at the face of the insulation.....	37
Figure 22. Annualized energy related costs versus average source energy savings for Dallas, Texas.....	107
Figure 23. Average source energy savings reduction versus insulation level for Dallas, Texas...	108
Figure 24. Annualized energy related costs versus average source energy savings for Kansas City, Missouri	108
Figure 25. Average source energy savings reduction versus insulation level for Kansas City, Missouri	108
Figure 26. Annualized energy related costs versus average source energy savings for Boston, Massachusetts	109
Figure 27. Average source energy savings reduction versus insulation level for Boston, Massachusetts	109
Figure 28. Annualized energy related costs versus average source energy savings for Duluth, Minnesota	110
Figure 29. Average source energy savings reduction versus insulation level for Duluth, Minnesota	110

Unless otherwise noted, all figures were created by BSC.

List of Tables

Table 1. Benchmark House Characteristics	3
Table 2. Parametric Steps and Cost.....	3
Table 3. Reference Cities.....	4
Table 4. Insulation Materials	8
Table 5. Design Withdrawal Values for Various Common Screw Fasteners	9
Table 6. Adjustment Factors	9
Table 7. Allowable Design Wind Pressure (psf).....	10
Table 8. Yield Modes from AF&PA TR-12	11
Table 9. Nominal 5% Offset Limit (lb) at Connection Yield Mode for #8 Wood Screws.....	12
Table 10. Nominal 5% Offset Limit (lb) at Connection Yield Mode for #10 Wood Screws.....	13
Table 11. Nominal 5% Offset Limit (lb) at Connection Yield Mode for #12 Wood Screws.....	13
Table 12. Nominal 5% Offset Limit (lb) at Connection Yield Mode for ¼-in. Lag Screws.....	13
Table 13. Target Loads for Short-Term Deflection Testing	15

Unless otherwise noted, all tables were created by BSC.

Definitions

AF&PA	American Forest & Paper Association
BEopt	Building Energy Optimization (software). More information about BEopt can be found at http://beopt.nrel.gov/
BSC	Building Science Corporation. More information about BSC can be found at www.buildingscience.com
CMU	Concrete masonry unit
EPS	Expanded polystyrene
FSC	Foam Sheathing Coalition
ft ²	Square foot
in.	Inch
lb	Pound
NDS	National Design Specification for Wood Construction
NYSERDA	New York State Energy Research and Development Authority
OSB	Oriented strand board
PIC	Polyisocyanurate
psf	Pounds per square foot
RH	Relative humidity
s	Second
SFA	Steel Framing Alliance
SPF	Spruce-Pine-Fir
TR-12	General Dowel Equations for Calculating Lateral Connection Values: AF&PA Technical Report 12 (AF&PA 1999)
WRB	Water resistive barrier
XPS	Extruded polystyrene

Executive Summary

Exterior insulation is an effective means for increasing the overall thermal resistance of wall assemblies. It also has other advantages including improved water management and often increased airtightness of the building. The engineering basis and support work for exterior insulation, however, has not been conducted, resulting in obstacles for building official and building code acceptance. Additionally, water management strategies and integration practices for window systems, door systems, decks, balconies, and roof wall intersections have not been adequately developed. This gap also stands in the way of wider deployment.

In this research project, the Building Science Corporation (BSC) developed baseline engineering analysis to support the installation of thick layers of exterior insulation (2 in. to 8 in.) on existing masonry walls and wood framed walls. Wood furring strips (fastened through the insulation back to the structure) were used as a cladding attachment location. Water management details necessary to connect the exterior insulated wall assemblies to roofs, balconies, decks, and windows were created as guidance for integrating exterior insulation strategies with other enclosure elements.

Wind load withdrawal resistance capacities were determined based on guidance outlined in the *National Design Specification for Wood Construction* (American Forest & Paper Association 2005, Chapter 11, “Dowel Type Fasteners”). In all cases, the withdrawal capacity is independent of the thickness of the exterior insulation.

Analysis of gravity load capacity is more complex and has multiple variables that needed to be considered for the cladding attachment. BSC completed a numerical analysis for insulation thicknesses from 1 in. to 8 in. (in 1-in. increments). The laboratory testing was limited to 4-in.-thick installations and 8-in.-thick installations. The intent was that the results from the 4-in. test could be applied to installations up to 4 in. and the 8-in. test results could be applied to installations between 4 in. and 8 in.

BSC determined that acceptable deflection instead of ultimate capacity of the systems governed the design. For lap sidings and panel claddings with joints (metal, vinyl, wood, and fiber cement), movement is aesthetic in nature and not a health and safety issue. The acceptable amount of deflection will be a function of acceptable aesthetics for the cladding system chosen. For most lap siding or panel cladding systems, variations up to 1/16 in. or even 1/8 in. may be acceptable because the material and installation tolerances are easily greater than the potential gap development. BSC recommends, then, that the deflection be limited to 1/16 in. in service unless it is demonstrated that larger deflections can be tolerated.

For brittle claddings (such as stucco and cultured stone), movement could lead to cracking and potentially spalling of the material. For these systems BSC recommends that the in-service deflection limit be set to prevent deflection that may damage the cladding or impair its function. A limit of 1/64 in. is proposed for brittle claddings after initial deflection.

Most common residential cladding systems (metal, vinyl, wood, and fiber cement) are lightweight enough (<5 psf) that attachment to furring over any thickness of insulation does not create an issue. For these cladding systems, the predicted deflection based on a reasonable

horizontal spacing (16-in. to 24-in. on center) and vertical fastener spacing (up to 24-in. on center), is so slight (1/200 in.), and creep effects are so minimal, that the deflection does not approach the proposed 1/16-in. maximum in-service deflection limit.

For heavier cladding systems (>10 psf) initial deflection is within the proposed deflection limit. There is, however, inadequate information about potential thermal and moisture expansion and contraction movements, as well as creep effects of certain insulation materials in exposed environments, to predict long-term service deflection. Additional research into the long-term deflection movement of heavier claddings in exposed environments is needed.

Integrating exterior insulation into the water management strategy of the building takes careful detailing at interfaces with other enclosure elements.

For the most part, placing the water resistive barrier to the exterior of the insulation has been the easiest because the details are largely similar to standard construction practices. Concern is often raised about how to support elements that were once positioned in the structural frame wall, which are now “pushed” outward into the plane of the exterior insulation (e.g., windows and step flashings). Careful use of blocking or box extensions can be integrated into the design to address these concerns.

Conversely, placing the water resistive barrier inboard of the exterior insulation has been more difficult for contractors to adopt because of some significant departures from standard construction details and common construction sequences. These concerns increased when these techniques were applied to a building retrofit. This does have, however, the benefits of placing the water resistive barrier in a more protected location (increasing durability), and locating the window in the plane of the existing framing.

BSC developed details to serve as guidance on how to effectively maintain the continuity of the water management. These details are presented in Appendix A of this report.

1 Problem Statement

1.1 Introduction

The underlying concept of insulating the exterior of existing masonry walls and wood framed walls is simple; it has a variety of advantages for durability and air barrier continuity (Lstiburek 2007; Hutcheon 1964). Even though the practice should be simple, several problems stand in the way of widespread implementation. For example, manufacturers of cladding systems and exterior insulation materials often limit thicknesses to 1½ in. with their warranties; the cladding attachment, then, becomes an issue. This problem has been tackled by various practitioners (Crandell 2010; Ueno 2010; Joyce 2009; Pettit 2009; Straube and Smegal 2009). Demonstrations by members of the Building Science Corporation (BSC) research team, which carried out the work described in this report, have shown that up to 8 in. of exterior insulation over the exterior of wood framed buildings is possible (Lstiburek 2009). The engineering basis and support work, however, has not been conducted, resulting in obstacles for building official and building code acceptance. Additionally, water management strategies and procedures for integrating roofs, balconies, decks, and window systems have not been adequately developed. This gap also stands in the way of wider deployment.

In this research project, BSC developed baseline engineering analysis to support the installation of thick layers of exterior insulation (2 in. to 8 in.) on existing masonry walls and wood framed walls. Wood furring strips (fastened through the insulation back to the structure) were used as a cladding attachment location. Water management details necessary to connect the exterior insulated wall assemblies to roofs, balconies, decks, and windows were also created, resulting in guidance on integrating exterior insulation strategies with other enclosure elements. The details give consideration to both complete retrofit and phased retrofit approaches, furnishing connection details that allow for future integration with other high performance enclosure system elements.

1.2 Background

The existing residential building stock represents a significant portion of U.S. energy consumption. The residential and commercial building sectors consumed roughly 40% of the primary energy used in the United States in 2008. The residential sector consumed 21% and the commercial sector consumed 18% (U.S. Department of Energy, Energy Information Administration 2008). New construction represents only a small fraction of the total building stock in the country. The adoption of energy codes in many states has helped drive a move toward lower energy use buildings, but the existing building stock remains, for the most part, untouched.

In the past, retrofits of existing residential buildings typically involved the filling of framed cavity walls with insulation. The amount of effective thermal resistance that could be added, though, was limited by the existing stud cavity depth (wood framed walls) or strapping depth (common for mass masonry walls), the insulation material used (commonly fiberglass/mineral fiber or cellulose), and the amount of thermal bridging present from the wood framing.

Adding insulation to the exterior of existing buildings has been a method used by retrofit contractors to overcome these limitations and achieve higher effective R-values for wall

assemblies. The benefits of this approach extend beyond added thermal resistance; increased building durability and airtightness are often also realized.

BSC has been involved with numerous new construction and building retrofit projects that have used exterior insulation as part of the building energy use reduction strategy. Experience has shown that two primary questions are often raised:

- How will the cladding be attached?
- How will the water management of the assembly be accomplished?

1.3 Cost Effectiveness

In most circumstances, the exterior retrofit of a home with exterior insulation comes as part of a larger scope of work for a building retrofit. The choice to add exterior insulation is usually triggered by the need (or desire) to re-clad or overclad the building. The driving force behind installing new cladding can include existing water management problems, comfort or durability concerns, end of service life for the cladding, or aesthetic issues. The need to replace the cladding gives the designer or contractor an opportunity to include exterior insulation as a way to increase the energy performance of the building at the same time. The cost effectiveness of this from an energy perspective is therefore dependent on the cost of the insulation as well any associated components above and beyond the new cladding installation.

BSC completed a preliminary evaluation that looked at the incremental cost of the varying thicknesses of insulation installed to the exterior of the wall assemblies. This preliminary cost analysis used foil-faced polyisocyanurate (PIC) as the baseline exterior insulation. Cost data for the exterior insulation were taken from RSMeans Construction Data (Reed Construction Data 2011). Costs included in the analysis were the installed cost of the insulation material, 1 × 4 wood furring strips spaced at 16-in.on center (o.c.), and wood screws spaced at 24 in. o.c. vertically for the attachment of the furring back to the structure. A cost markup of \$100.00 per window was used in the reference model as an estimate of the additional cost for trim extensions that would be needed to account for the additional thickness of the exterior insulation. This value was estimated because actual costs can be highly variable. This variability results from the many different design choices available for window placement, exterior window trim design, and attachment.

Other items such as house wrap or sheathing tape, self-adhered membrane flashings, metal flashings, siding, and siding fasteners were omitted from the analysis. These items are associated with re-cladding and water management, and would be part of the retrofit project regardless of the addition of exterior insulation.

BSC ran simulations using Building Energy Optimization (BEopt) simulation software developed by the National Renewable Energy Laboratory. An example home was used as the baseline to help demonstrate the benefits of using exterior insulation as part of a house energy retrofit. This benchmark home was assumed to be around 1950's era two-story slab on grade construction. Table 1 gives its basic characteristics.

Table 1. Benchmark House Characteristics

House Characteristics	ft ²
Finished Floor Area	2,312
Ceiling Area	1,156
Slab Area	1,156
Wall Area	2,799
Window Area	410 (17.7% glazing ratio)

To examine the effectiveness of this single strategy, the wall conductance performance was isolated from all other aspects of the home. Given the assumed age of the home, the benchmark home had an uninsulated wall cavity (as per guidance from the 2011 Building America Benchmark Protocol).¹ The parametrics listed in Table 2 were run to see the effectiveness of the added thermal resistance in regard to the energy performance and utility cost.

Table 2. Parametric Steps and Cost

Parametric Step	Cost/ft ²
Benchmark (Uninsulated 2 × 4 Wall)	N/A
R-13 Cavity Fill Insulation	\$2.20
R-13 Cavity Fill + 1-in. Exterior Insulation (R-6.5)	\$3.55
R-13 Cavity Fill + 1.5-in. Exterior Insulation (R- 9.75)	\$3.76
R-13 Cavity Fill + 2-in. Exterior Insulation (R-13) + 1 × 4 Wood Furring	\$5.73
R-13 Cavity Fill + Two Layers of 1.5-in. Exterior Insulation (R-19.5) + 1 × 4 Wood Furring	\$7.19
R-13 Cavity Fill + Two Layers of 2-in. Exterior Insulation (R-26) + 1 × 4 Wood Furring	\$7.58
R-13 Cavity Fill + Four Layers of 2-in. Exterior Insulation (R-52) + 1 × 4 Wood Furring	\$11.07

Results indicated that for cold-climate zones (4 and higher), insulation up to 1.5 in. was a cost-optimized solution. This was mainly because this was the tipping point before which additional costs—associated with the furring strips and additional screw fasteners required for cladding attachment—needed to be added to the system. Insulation thicknesses up to 4 in. were demonstrated to be cost neutral as part of this simplified analysis in all cities except for Dallas, Texas (see Table 3 for reference cities). Insulation thicknesses up to 8 in. were demonstrated to be cost neutral, but only in cold-climate zones such as Boston, Massachusetts, and Duluth, Minnesota (see Appendix B for the results).

Although the analysis focused on conductance improvements only, some argument can be made that adding exterior insulation would likely also improve the overall airtightness of the assemblies (Ueno 2010). The benefits of increased airtightness are known to be very important in

¹ More information about Building America can be found at www.buildingamerica.gov.

cold-climate construction; however, it is also more difficult to isolate and apportion to individual measures.

Table 3. Reference Cities

City	Climate Zone
Dallas, Texas	3A
Kansas City, Missouri	4A
Boston, Massachusetts	5A
Duluth, Minnesota	7A

1.4 Other Benefits

Using exterior insulation has many additional benefits other than increased thermal resistance. The single largest benefit is the increased condensation resistance that this strategy provides for cold-climate buildings. The placement of the insulation to the exterior of the building acts to keep all of the structural elements at a much more even temperature throughout the year, reducing the risk of interstitial condensation. For wood structures, this can significantly reduce the potential for wood decay; an added benefit is that the seasonal thermal and moisture variations of the wood frame are greatly reduced. In masonry building, the potential for freeze thaw is practically eliminated because this approach not only keeps the masonry warmer, but also addresses exterior rain water absorption into the masonry (which is the leading moisture source related to freeze thaw damage to buildings).

In addition to keeping the structure warm and preventing condensation, the increase in drainage and drying that results from the 3/4-in. gap created by the furring strips offers additional protection against water infiltration problems (Lstiburek 2010). The benefit is significant enough that the use of furring strips is a base recommendation for all cladding installations whether exterior insulation is used or not. The fact that the furring strips are an intrinsic component of this system adds a significant benefit to the long-term durability of these wall assemblies.

2 Cladding Attachment Design

Attaching the cladding over exterior insulation encounters two common barriers:

- Cladding manufacturers that limit their warranties for installations of their cladding systems over only 1 in. to 1½ in. of insulation.
- Availability of fasteners that are long enough to fasten through the cladding and insulation, while still maintaining the required embedment depth into the structure, is limited.²

To overcome these constraints, furring strips have been added as a cladding fastening location for assemblies when thicker levels of exterior insulation are used (2 in. and greater). This addresses the cladding manufacturer's warranty and allows readily available fasteners and common cladding fastening procedures to be used.

For wood framed walls, long screws are used to attach the furring strips through the insulation back to the wood structure. For mass masonry walls an interim step is needed. To allow for an attachment point for the furring, wood 2 × 4 members (installed on the flat) are first attached to the masonry wall structure. The furring is then fastened back through the insulation to the 2 × 4 framing members with screws (see Figure 1).

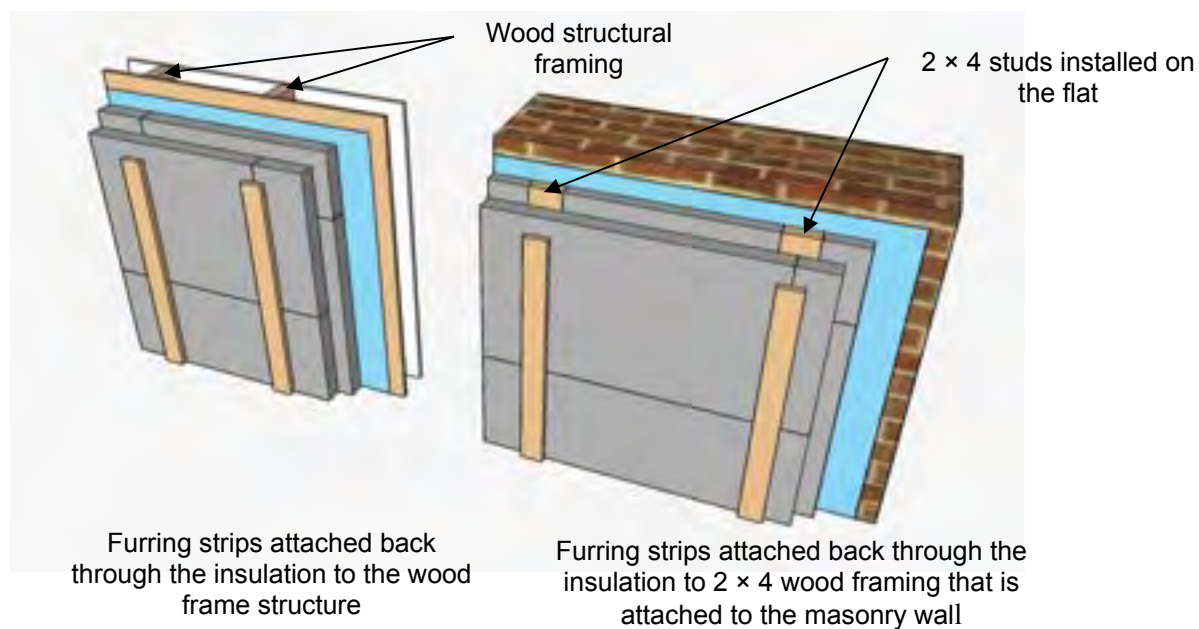

Figure 1. Recommended cladding attachment design

² Most pneumatic nail guns have a maximum fastener length limit of 3 in. to 3.5 in. This limits the amount of insulation that can be placed between the siding and the substrate in a direct siding application.

Attaching cladding to furring strips that are fastened back through the exterior insulation has been used on numerous Building America test homes and communities in both new and retrofit applications. This strategy has been proven to be an effective and durable way to attach cladding (BSC 2010; BSC 2009a; BSC 2009b). The lack of engineering data, though, has been a problem for many designers, contractors, and code officials. Concerns about sagging of the cladding from rotation of the fasteners and compression of the insulating sheathing are often raised.

2.1 Previous Research

Recently, studies undertaken by the Foam Sheathing Coalition (FSC), along with a joint research project by the New York State Energy Research and Development Authority (NYSERDA) and the Steel Framing Alliance (SFA) completed some testing and analysis to develop prescriptive code tables for attaching cladding to framing over continuous insulation. This work included conducting some laboratory testing of lateral load resistance for various configurations of cladding and furring types fastened through exterior insulation into wood or steel framed wall assemblies. Two criteria were evaluated when examining the connection performance: (1) overall strength of the connection and (2) acceptable deflection performance

The acceptable deflection limit is a performance requirement to limit the amount of vertical deflection that the installed weight of the cladding will induce on the furring strips. Excessive deflection could lead to concerns about gaps developing between the siding and other enclosure elements (such as windows, window trim, or other trim materials).

As part of the FSC and NYSEDA/SFA research, the acceptable deflection limit was set to a maximum of 0.015 in. (or 1/64 in.; Crandell 2010). The 0.015-in. deflection limit has a long-standing basis for wood connection design values used in the *National Design Specification for Wood Construction* (known as the NDS; American Forest & Paper Association [AF&PA] 2005). The FSC and NYSEDA/SFA research determined that in all cases the 0.015-in. deflection limit, not the average shear strength, controlled the design values for the capacities of the systems.

A secondary aspect of the FSC and NYSEDA/SFA research was to verify the accuracy of applying current engineering knowledge about wood to wood connections using the NDS Yield Theory (as detailed in *General Dowel Equations for Calculating Lateral Connection Values: AF&PA Technical Report 12* [TR-12]; AF&PA 1999) in predicting connection capacities. The researchers discovered that the 5% offset yield prediction as calculated using the TR-12 resulted in a reasonably accurate prediction of the shear load at a deflection of 0.015 in. Although there is no mathematical connection between these values, the investigators considered this an adequate basis for designing to a 0.015-in. deflection limit given the limited amount of research and funding that had been available to that point. In addition, a safety factor of 1.5 was added to the calculated results to address potential concerns of creep of materials under sustained loads. The choice of the 1.5 safety factor was based on several factors including precedence in the NDS and limited long-term deflection testing; however, a significant amount of uncertainty still surrounds the actual amount of predicted creep. Additional research is needed in this area.

This work resulted in the development of proposed code tables that set forth prescriptive requirements for attaching cladding over exterior insulating sheathing (see Figure 2). The table was developed using calculated results from the TR-12 supported by laboratory testing of a

representative but limited selection of various cladding attachment and fastener configurations. The table prescribes a maximum amount of insulation that can be installed based on maximum cladding weight, stud spacing, and vertical fastener spacing. This testing addressed attachments to wood and steel framing in addition to wood sheathing. Attachment to other materials such as masonry was not investigated.

**TABLE 8
FURRING MINIMUM FASTENING REQUIREMENTS
FOR APPLICATION OVER FOAM PLASTIC SHEATHING
TO SUPPORT SIDING WEIGHT^{1,2}**

Furring Material	Framing Member	Fastener Type and Minimum Size	Minimum Penetration into Wall Framing (inches)	Fastener Spacing in Furring (inches)	Maximum Thickness of Foam Sheathing (inches)						Allowable Design Wind Pressure (psf)		
					18"oc Furring ⁴			24"oc Furring ⁴			18"oc Furring	24"oc Furring	
					Siding Weight			Siding Weight					
					3 psf	11 psf	25 psf	3 psf	11 psf	25 psf			
Minimum 1x Wood Furring ³	Minimum 2x Wood Stud	Nail (0.120" shank, 0.271" head)	1-1/4	8	4	4	1.5	4	2	1	42.6	28.4	
				12	4	2	1	4	1.5	0.5	28.4	18.9	
				16	4	2	0.5	4	1	DR	21.3	14.2	
			Nail (0.131" shank, 0.281" head)	1-1/4	8	4	4	2	4	3	1	46.5	31.0
					12	4	3	1	4	2	0.75	31.0	20.7
					16	4	2	0.75	4	1.5	DR	23.3	15.5
		#8 wood screw ²	1	12	4	4	1.5	4	3	1	98.9	66.0	
				16	4	3	1	4	2	0.5	74.2	49.5	
				24	4	2	0.5	4	1	DR	35.1	23.4	
		1/4" lag screw ²	1-1/2	12	4	4	3	4	4	1.5	140.4	93.6	
				16	4	4	2	4	3	1	79.0	52.7	
				24	4	3	1	4	2	0.5	35.1	23.4	
Minimum 33mil Steel Hat Channel or Minimum 1x Wood Furring ³	33 mil Steel Stud	#8 screw (0.280" head)	Steel thickness +3 threads	12	3	1.5	DR	3	0.5	DR	52.9	35.3	
				16	3	1	DR	2	DR	DR	39.7	26.5	
				24	2	DR	DR	2	DR	DR	26.5	17.8	
		#10 screw (0.330" head)	Steel thickness +3 threads	12	4	2	DR	4	1	DR	62.9	41.9	
				16	4	1.5	DR	3	DR	DR	47.1	31.4	
				24	3	DR	DR	2	DR	DR	31.4	21.0	
	43 mil or thicker Steel Stud	#8 screw (0.280" head)	Steel thickness +3 threads	12	3	1.5	DR	3	0.5	DR	69.0	46.0	
				16	3	1	DR	2	DR	DR	51.8	34.5	
				24	2	DR	DR	2	DR	DR	34.5	23.0	
		#10 screw (0.330" head)	Steel thickness +3 threads	12	4	3	1.5	4	3	DR	81.9	54.8	
				16	4	3	0.5	4	2	DR	61.5	41.0	
				24	4	2	DR	4	0.5	DR	35.1	23.4	

For SI: 1" = 25.4 mm; 1 pound per square foot (psf) = 0.0479 kPa. DR = design required

- Table values are based on: (1) minimum 3/4-inch (19.1 mm) thick wood furring and wood studs of Spruce-Pine-Fir or any softwood species with a specific gravity of 0.42 or greater per AF&PA/NDS, (2) minimum 33 mil steel hat channel furring of 33 ksi steel, and (3) steel framing of indicated nominal steel thickness and minimum 33 ksi steel for 33mil and 43 mil steel and 50 ksi steel for 54 mil steel or thicker. Steel hat channel shall have a minimum 7/8-inch (22.2 mm) depth.
- Fasteners shall comply with appropriate standards and manufacturer's installation instructions, or be otherwise approved for the intended application.
- Where the required siding fastener penetration into wood material exceeds 3/4 inch (19.1 mm) and is not more than 1-1/2 inches (38.1 mm), a minimum 2x wood furring shall be used unless approved deformed shank siding nails or siding screws are used to provide equivalent withdrawal strength allowing connection to 1x wood furring.
- Furring shall be spaced a maximum of 24"oc in a vertical or horizontal orientation. In a vertical orientation, furring shall be located over wall studs and attached with the required fastener spacing. In a horizontal orientation, furring strips shall be fastened at each stud intersection with a number of fasteners equivalent to the required fastener spacing. In no case shall fasteners be spaced more than 24 inches (0.6 m) apart.
- Lag screws shall be installed with a standard cut washer. Lag screws and wood screws shall be pre-drilled in accordance with AF&PA/NDS. Approved self-drilling screws of equal or greater shear and withdrawal strength shall be permitted without pre-drilling.
- Refer to Appendix D for additional requirements related to use of this table.

Figure 2. Table 8 excerpt from Crandell (2010)

(Used with permission)

The results of this earlier research laid a good foundation for guidance on cladding attachment. Several key questions were answered; however, the work has led to other questions about the deflection of the furring strips:

- What is the impact of different insulation materials?
- What is the impact of increased thicknesses beyond 4 in.?
- What is the impact of prolonged loading?

To answer these questions, BSC designed the research described in this report. The BSC research team examined the problem using engineering numerical analysis and laboratory testing of cladding attachment using furring strips. The analysis examined the ability of the system to resist wind withdrawal loads, initial (short-term) gravity loading, and prolonged (long-term) gravity loading of cladding systems.

The numerical analysis portions were completed following standards set out in the 2005 NDS (AF&PA 2005) and the TR-12 document (AF&PA 1999). The numerical analysis examined both wind withdrawal load and vertical gravity load resistance of the assemblies.

Laboratory testing was designed to examine short-term as well as long-term loading performance for several common types of exterior insulation materials. Table 4 lists the materials used in each of the tests conducted.

Table 4. Insulation Materials

Insulation Type	Product	Brand
Type II Expanded Polystyrene (EPS)	Plastispan	Plastifab
Type IV Extruded Polystyrene (XPS)	C-200	Owens Corning
Foil-Faced PIC	Thermax CI	DOW Chemical
Rigid Mineral Fiber	RB80	Roxul

The laboratory work was also designed to expand on insulation thicknesses using 4-in.-thick material (two layers, 2 in. thick) for the baseline tests. Additional testing of 8-in.-thick material (four layers, 2 in. thick) was conducted. Other variables such as stud spacing, furring strip dimensions, and fastener types were maintained across each test; however, different fastener types were needed for thicker insulation installations.

2.2 Wind Load Resistance

Wind load withdrawal resistance is a function of the fastener withdrawal capacity and is independent of the length of the fastener. As a result, insulation thickness has no bearing on the withdrawal capacity of the fastener. Withdrawal capacities of fasteners have been well studied and documented. Design capacities can be determined following design guidelines set out in the 2005 NDS (AF&PA 2005). Because of this, no laboratory testing was deemed to be necessary.

2.2.1 Numerical Analysis

Fastener withdrawal resistance was evaluated under Chapter 11, “Dowel-Type Fasteners” of the 2005 NDS (AF&PA 2005). The withdrawal strength is determined by the following equations:

$$W = 1800 \cdot G^{3/2} \cdot D^{3/4} \quad (\text{for lag screw attachment})$$

$$W = 2850 \cdot G^2 \cdot D \quad (\text{for wood screw attachment})$$

$$W = 1380 \cdot G^{5/2} \cdot D \quad (\text{for nail and spike attachment})$$

where

W = Withdrawal strength (per inch of embedment)

G = Specific gravity of wood

D = Unthreaded diameter.

To be consistent with earlier research, Spruce-Pine-Fir (SPF) or any other softwood species with a specific gravity of 0.42 per the 2005 NDS was used as the minimum in the calculation. Wood members with higher specific gravity numbers will result in increased capacity. Design values were calculated for the common fastener types listed in Table 5.

Table 5. Design Withdrawal Values for Various Common Screw Fasteners

Fastener Type	Unthreaded Shank Diameter (in.)	Withdrawal Capacity per Inch of Thread Penetration
#8 Wood Screws	0.164	82 lb
#10 Wood Screws	0.190	96 lb
#12 Wood Screws	0.216	109 lb
¼-in. Lag Screws	0.250	173 lb

The calculated withdrawal values were multiplied by the adjustment factors given in Table 6 as outlined in *Table 103.1 Applicability of Adjustment Factors for Connections* (NDS 2005) per the 2005 NDS to determine the allowable stress design (ASD) adjusted design values.

Table 6. Adjustment Factors

Adjustment Factors		
Load Duration Factor	CD =	1.6
Wet Service Factor	CM =	1.0
Temperature Factor	Ct =	1.0
End Grain Factor	Ceg =	1.0
Toe-Nail Factor	Ctn =	1.0

The results were tabulated based on horizontal spacing of furring strips and vertical spacing of the fasteners (see Table 7).

Table 7. Allowable Design Wind Pressure (psf)

	#8 Wood Screw		#10 Wood Screw		#12 Wood Screw		¼-in. Lag Screw	
	Furring Spacing (in.)		Furring Spacing (in.)		Furring Spacing (in.)		Furring Spacing (in.)	
Vertical Fastener Spacing	16	24	16	24	16	24	16	24
8 in.	148	99	172	115	195	130	301	200
12 in.	99	66	115	76	130	87	200	134
16 in.	74	49	86	57	98	65	150	100
24 in.	49	33	57	38	65	43	100	67

2.3 Gravity Load Resistance

Unlike the wind load resistance and the fastener withdrawal values, the lateral load capacity of wood furring installed over exterior insulating sheathing does not have well-defined guidance. To evaluate the lateral load capacity of furring strips installed over insulation as a cladding attachment system, laboratory testing and computational analyses were completed.

2.3.1 Numerical Analysis

Using the FSC and NYSERDA/SFA research as a starting point (Crandell 2010), the 5% offset yield values were calculated for various insulation thickness using the methodology set out in the TR-12 document (AF&PA 1999). Six modes of failure are evaluated in the general dowel equations (Table 8). The failure modes are functions of either crushing (bearing failure) in the wood members or bending (yielding) of the dowel fastener. An example of a mode IV failure (dowel yielding in the side and main member) can be seen in Figure 3.

Table 8. Yield Modes from AF&PA TR-12





Yield Mode	Description	Graphic
I_m	Main Member Bearing Failure	
I_s	Side Member Bearing	
II	Side and Main Member Bearing	
III_m	Main Member Bearing and Dowel Yielding in the Side Member	
III_s	Side Member Bearing and Dowel Yielding in the Main Member	
IV	Dowel Yielding in the Side and Main Member	

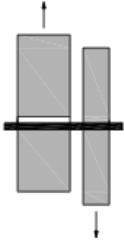
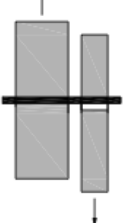

Figure 3. Example of fastener yielding in Mode IV

Four types of screw fasteners were used (#8 wood screw, #10 wood screw, #12 wood screw, and ¼-in. lag screw). These four are the most common fasteners expected to be used for attaching wood furring back to the structure.

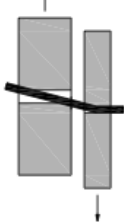
A minimum penetration depth of 1.5 in. was assumed for all fasteners into the primary support member. A 0.75-in. bearing of the fastener in the furring was assumed. Similar to the withdrawal capacity calculations, the minimum specific gravity of both the wood stud and the wood furring strip was set to 0.42.

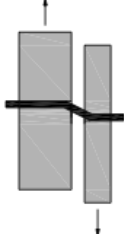
Nominal design values (values before any safety factors are applied) for each of the baseline fasteners used are given in Table 9 through Table 12. The design value is the lowest yield limit for all of the failure modes evaluated. For most cases, yield mode IIIs governs, except for #8 wood screws where for larger gaps, yield mode IV governs (see dashed red lines in tables). These calculated results are consistent with observed yield failures noted during laboratory testing.

Table 9. Nominal 5% Offset Limit (lb) at Connection Yield Mode for #8 Wood Screws

Gap (in.)	Im	Is	II	III _m	III _s	IV
1	565	414	128	141	66	75
2	565	414	90	96	40	42
3	565	414	69	72	29	28
4	565	414	56	57	22	22
5	565	414	47	48	18	17
6	565	414	40	41	15	14
7	565	414	35	36	13	12
8	565	414	32	32	12	11

Table 10. Nominal 5% Offset Limit (lb) at Connection Yield Mode for #10 Wood Screws

Gap (in.)	Im	Is	II	IIIIm	IIIIs	IV
1	656	479	148	170	80	101
2	656	479	104	116	49	57
3	656	479	80	87	35	39
4	656	479	65	70	27	30
5	656	479	54	58	22	24
6	656	479	47	50	19	20
7	656	479	41	43	16	17
8	656	479	37	38	14	15

Table 11. Nominal 5% Offset Limit (lb) at Connection Yield Mode for #12 Wood Screws

Gap (in.)	Im	Is	II	IIIIm	IIIIs	IV
1	747	545	169	208	97	143
2	747	545	119	142	59	83
3	747	545	91	107	42	57
4	747	545	74	85	33	44
5	747	545	62	71	27	35
6	747	545	53	61	23	29
7	747	545	47	53	20	25
8	747	545	42	47	17	22

Table 12. Nominal 5% Offset Limit (lb) at Connection Yield Mode for ¼-in. Lag Screws

Gap (in.)	Im	Is	II	IIIIm	IIIIs	IV
1	1221	882	275	322	151	201
2	1221	882	193	220	92	115
3	1221	882	148	165	66	79
4	1221	882	120	132	51	60
5	1221	882	101	110	42	48
6	1221	882	87	94	35	40
7	1221	882	76	82	31	34
8	1221	882	68	73	27	30

2.3.2 Short-Term Deflection Testing Protocol

The short-term (or initial loading) test method was designed to emulate whole-wall system effects in that the tests were conducted on full height assemblies (see Appendix C for the full test protocol). The intent was to minimize variations in the installation of a single fastener by

distributing the load over multiple fasteners (in these tests, 14 fasteners were used for each test panel). The test panels were 8-ft tall by 4-ft wide and anchored to a masonry block wall (see Figure 4). Each test panel consisted of the following:

- 2 × 4 wood studs at 24-in o.c.
- ¾-in. oriented strand board (OSB) sheathing
- Building wrap
- 4-in. or 8-in. exterior insulation (two or four layers of 2-in.-thick material with joints offset)
- 1 × 3 wood furring fastened back to the studs with #10 wood screws at a 16-in. o.c. vertical spacing (14 fasteners total per panel).



Figure 4. Short-term deflection test panel

The furring strips were loaded with a hydraulic ram, bringing up the load on the wall assembly to a specific target load and recording the deflection. The load was then released to examine the amount of plastic deformation created in the system to that point. The system was then reloaded up to the next target load and the protocol repeated. Table 13 gives the target loads. The hysteresis plots created by the loading and unloading of the test panels were designed to examine the amount of plastic deformation induced into the assembly at each load increment (see Figure 5).

Table 13. Target Loads for Short-Term Deflection Testing

Total Load (lb)	Load/ft ² (lb)	Load/Fastener (lb)
120	3.8	8.6
370	11.6	26.4
500	15.6	35.7
750	23.4	53.6
1,000	31.3	71.4

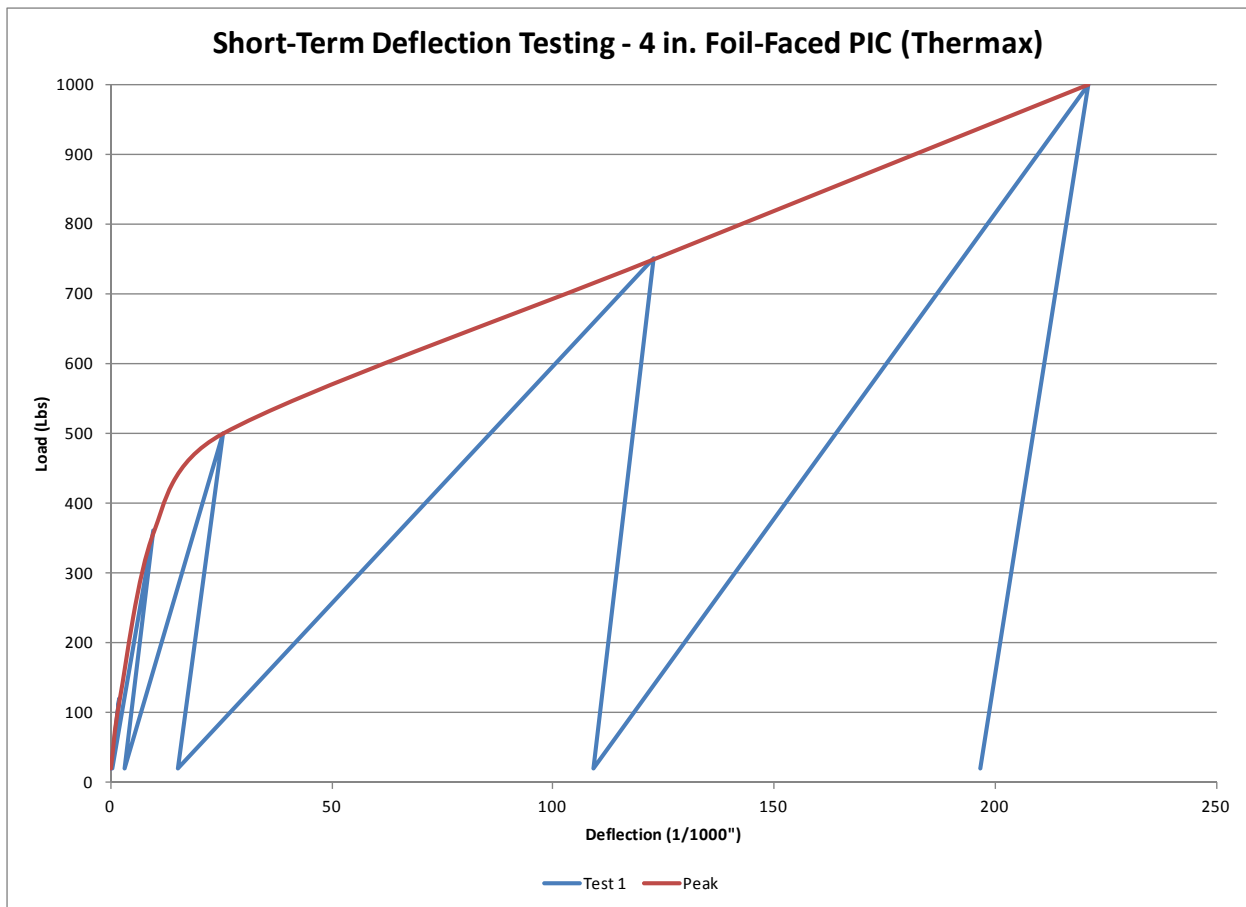

Figure 5. Example hysteresis test plot for short-term deflection testing

2.3.3 Long-Term Test Protocol

For the long-term testing, the test setup was reduced to a single furring because of space constraints and issues with equal load share over two furring strips with fixed dead weights (see Appendix D for the full test protocol). The test panels were 8-ft tall by 16-in. wide and anchored to a masonry block wall (see Figure 6). Each test panel consisted of the following:

- 2 × 4 wood stud (single stud)
- 3/8-in. OSB sheathing
- Building wrap
- 4-in. exterior insulation (two layers of 2-in. material with joints offset)
- 1 × 3 wood furring fastened back to the stud with #10 wood screws at 16 in. o.c. vertically (7 fasteners total per panel).



Figure 6. Long-term deflection test panel

The furring strips were loaded with a 213-lb dead weight (see Figure 7). Deflection readings were taken every 30 s during the initial loading of the test panels and several times during the first day of loading. After the first day, readings were typically taken each day for the following

month, and then every few days thereafter. Temperature and relative humidity (RH) readings were also recorded.



Figure 7. Dead weights attached to bottom edge of furring strips

2.3.4 Results and Discussion

2.3.4.1 Short-Term Deflection Testing

Figure 8 and Figure 9 summarize the results of the short-term deflection testing. The deflection recorded is the vertical movement differential between the OSB sheathing and the furring strips (averaged between the two furring strips). Overlaid on the charts are the ranges of weights by cladding types commonly used in the industry. In addition, the common deflection gap sizing is highlighted for reference.

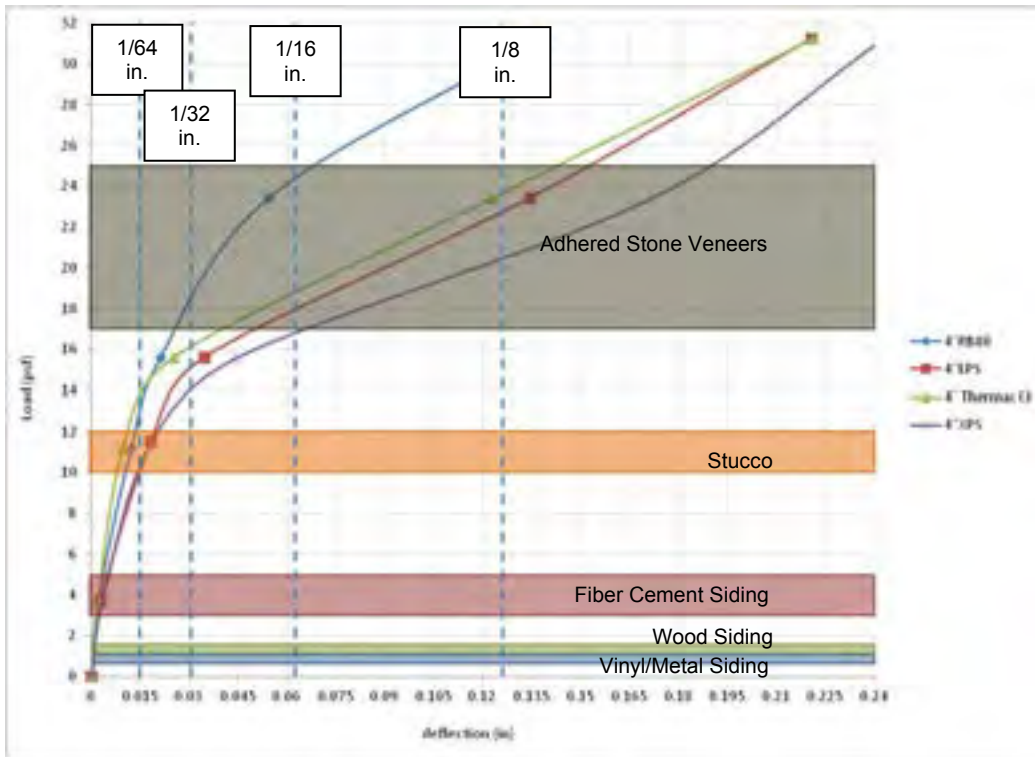

Figure 8. Short-term deflection testing results (4-in.-thick insulation)

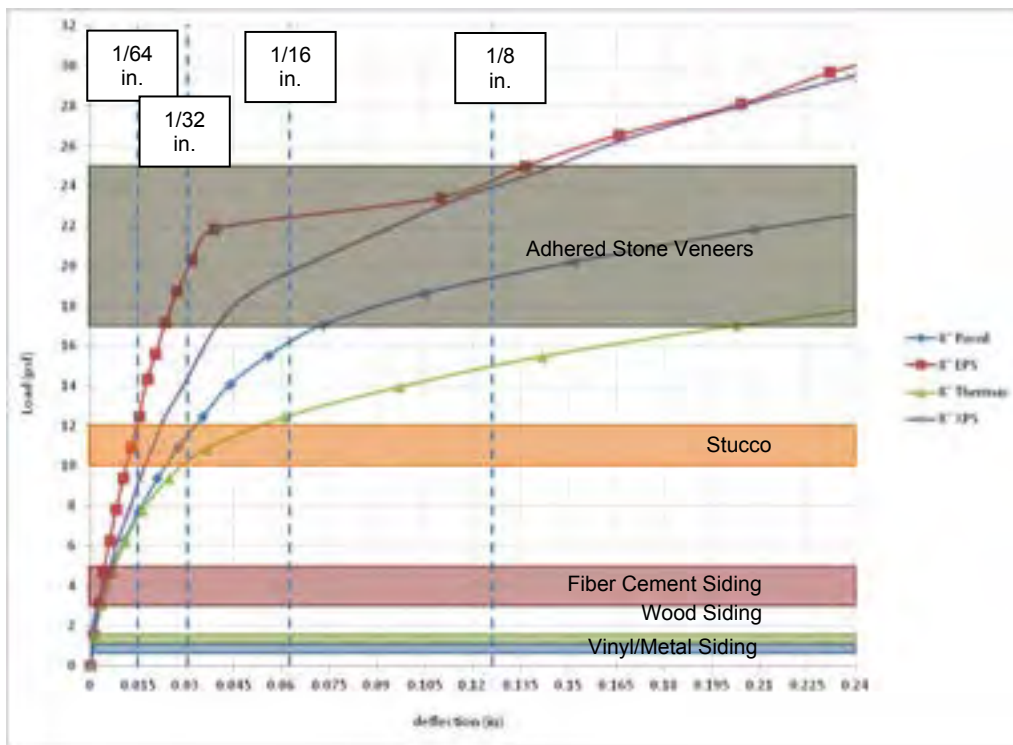

Figure 9. Short-term deflection testing results (8-in.-thick insulation)

The capacity of the system was developed from several sources including the bending strength of the fastener, the bearing strength of the furring and framing members, and the compressive strength of the rigid insulation, as well as other factors such as static friction between layers (see Figure 10).

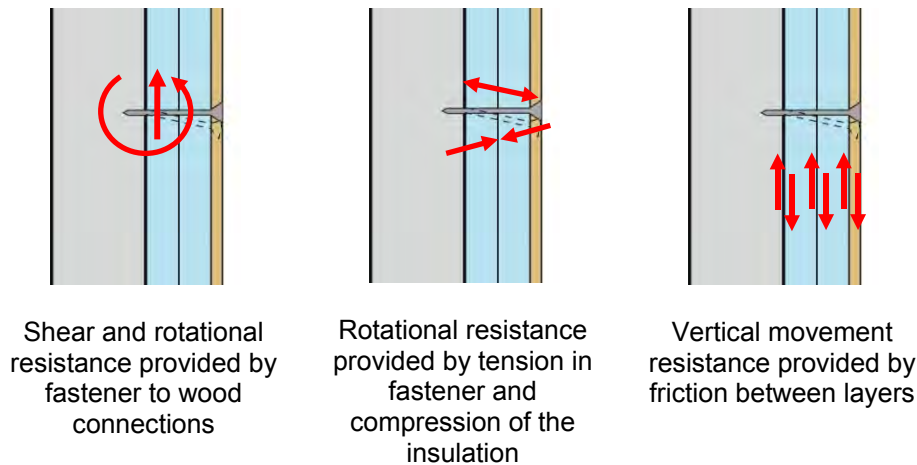

Figure 10. Forces providing vertical displacement resistance

Under initial loading, the load is taken up by the bending of the fasteners as well as the pre-compression forces induced on the insulation by the tightening of the furring. As the vertical load increases, a greater portion of the load will be placed on the insulation through increased compression. The increased compression load results from the bending and rotation of the fasteners, which creates a normal force on the insulation.

The deflection testing showed that friction between the various layers is reasonably significant in the development of the system capacity. During most of the tests conducted, slippage between layers occurred as the vertical load overcame the static friction between the layers. This resulted in jumps in the deflection readings. Slippage occurred between the layers in products with smoother surfaces; however, slippage was not seen for products with rougher surfaces such as the rigid mineral fiber insulation.

Because several factors are acting together to develop the system capacity, there is no linear relationship of system capacity to number of fasteners. In simpler terms, doubling the number of fasteners will not result in a doubling of system capacity. Also, because a portion of the capacity is based on compression forces on the exterior insulation from both rotational resistance as well as static friction resistance, variations in installation practices may have impacts on the initial capacity of the system until the insulation compression and static friction is developed.

Based on the system configuration used in the test setup (fasteners spaced 24-in. o.c. horizontally and 16-in. o.c. vertically), the deflection resulting from the dead weight for metal, vinyl, wood, and fiber cement siding would be approximately 0.005 in. (1/200 in.) or less for insulation thicknesses up to 8 in. For all practical purposes, deflections in this range could be considered as zero deflection because of other factors such as material tolerances, construction tolerances, and thermal expansion and contraction movement. In addition, moisture expansion and contraction movements are greater in magnitude for the materials under consideration.

For stucco cladding systems, the amount of deflection anticipated would still be small (less than 1/32 in. for up to 4 in. of insulation and less than 1/16 in. for up to 8 in. of insulation). Note that this initial deflection would happen before the stucco mortar was hydrated and would not cause cracking of the solid stucco systems later. For cracking concerns, long-term movement of the system would need to be reviewed.

For adhered stone veneers, the anticipated deflection given the stud spacing and fastener spacing used in the test begins to become more of a concern. Movement in excess of 1/8 in. for 4-in.-thick layers of insulation and 1/4 in. for up to 8 in. of insulation could be possible with very heavy stone and thick mortar layers. The capacity of the system could be increased by using closer stud spacing and closer vertical spacing of fasteners; however, a linear interpolation based on capacity per fastener may not yield the most accurate results because other factors are not considered in this simplification as discussed previously.

The effects of insulation type did not appear to have a significant effect on the developed capacity of the systems. The relative performances of the types of insulation changed between the 4-in. tests and the 8-in. test. For example, the PIC insulation had the second highest capacity for the 4-in. test, but the lowest measured capacity for the 8-in. test. It is probable that variances in installation practices have a greater impact on the performance than the type of insulation material used.

Examination of the data shows that at 0.015-in. deflection (1/64 in.), the capacities of the systems are around 10 psf (23 lb per fastener) for EPS and XPS and around 13 psf (29 lb per fastener) for PIC and mineral fiber insulation at a thickness of 4 in. As determined by the protocol in the TR-12 (AF&PA 1999), the predicted value for #10 wood screws with a 4-in. gap is 27 lb. The results correlate reasonably well with the findings of the FSC and NYSERDA/SFA research (Crandell 2010). For the 8-in. deflection testing there was a wider range of results at the 0.015-in. deflection. Capacities were measured between 7 psf (16 lb per fastener) for mineral fiber and PIC, 9 psf (21 lb per fastener) for XPS, and 12 psf (27 lb per fastener) for EPS. As determined by the protocol in the TR-12, the predicted value for #10 wood screws with an 8-in. gap is 14 lb. The predicted value was at the low end of the measured data, and the actual measured capacity was always higher.

2.3.4.2 *Long-Term Deflection Testing*

Figure 11 highlights the results of the long-term deflection testing. Overlaid on the chart are common deflection measurements. The systems were loaded with an ultimate load of 213 lb (13 psf at 24-in. o.c., 20 psf at 16 in.). The weight was chosen to be representative of heavier stucco (10 psf to 12 psf) or adhered stone veneer (17 psf to 25 psf) claddings. An additional test using XPS insulation was conducted with a dead weight of 53 lb (3 psf at 24-in. o.c., 5 psf at 16-in. o.c.) to see if the creep effects differed under small loading. This test was designed to simulate fiber cement cladding installation.

For all tests (other than the PIC sample) the long-term deflection values were less than or right around 1/32 in. after loading for 6 months. The deflection noted with the PIC sample seemed to be demonstrating more potential for ongoing creep. The maximum deflection reached 3/32 in. after 6 months with a relatively consistent movement trend.

There is some concern with the results of the PIC test. Two spikes in the deflection of the PIC were correlated with construction activities on the wall immediately adjacent to the PIC test setup. These construction activities were assumed to cause these spikes. Because of this, additional deflection noted in the PIC setup may result from the proximity of the test setup to other laboratory equipment and testing activities and not purely from creep effects of the insulation.

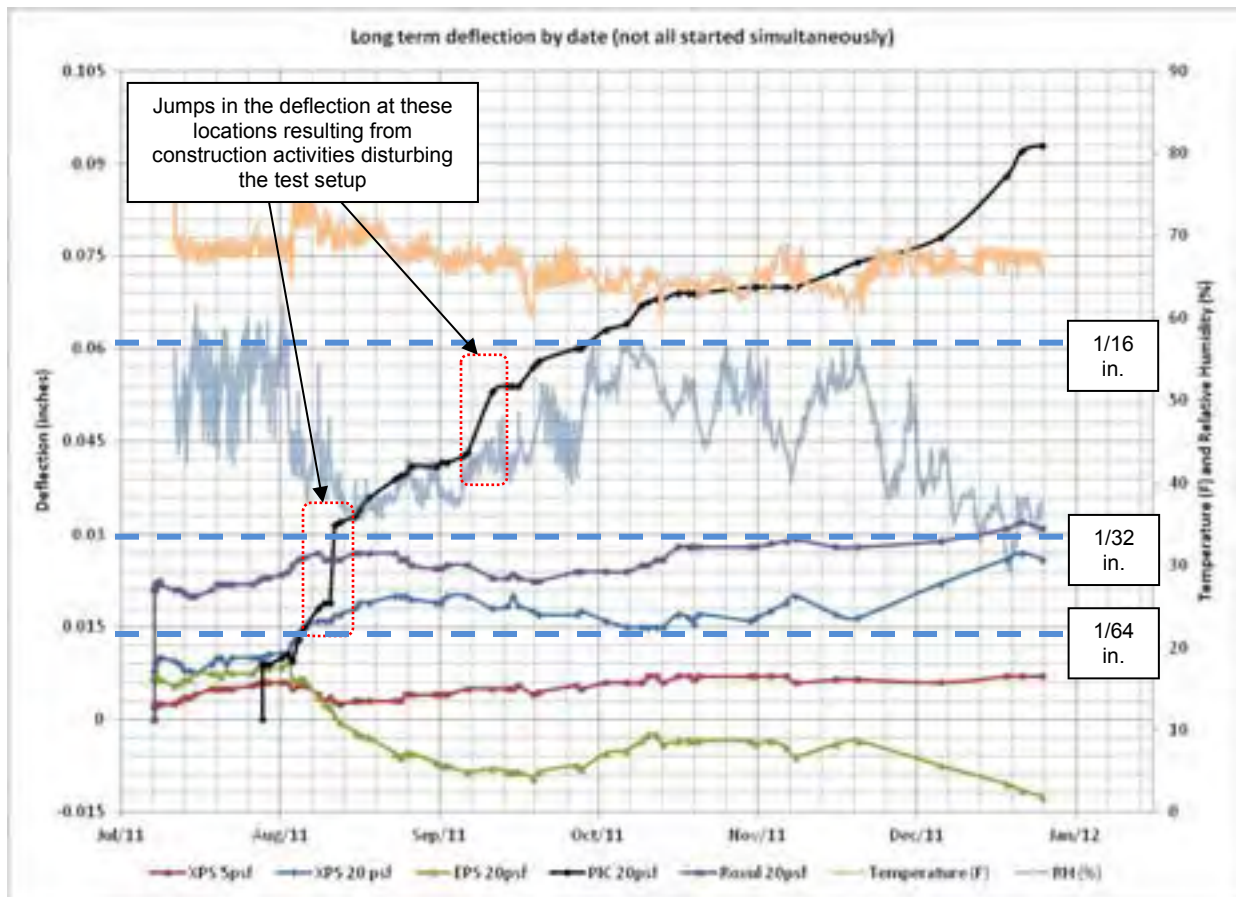

Figure 11. Deflection of furring strips under sustained load

In the early stages of the testing (the first 3 weeks after the initial loading), very minor additional downward vertical movement was seen. The temperature and RH, however, were maintained at a more stable range. In all cases a very slight trend for additional deflection can be seen. The magnitude, though, was on the order of 0.0025 in. (1/400 in.), and it might not result from creep effects from sustained loading. More substantial movement seemed to occur shortly after the first 3 weeks, when the temperature in the laboratory increased slightly (by approximately 5°F) and the RH dropped (from approximately 55% RH to 40% RH). Movements on the order of 0.01 in. or 1/100 in. were observed.

Looking at the complete data set, a slight trend in the movement appears to result from fluctuations in the temperature and RH. The temperature in the laboratory space fluctuated between 60°F and 75°F and the RH fluctuated between 60% and 30% over the course of the testing. Deflection movement in the test setups seems to track to these environmental changes. A

drop in the RH results in a general trend of an increase in the vertical downward deflection of the furring strips. It is interesting to note that the converse is true as well. An increase in the RH seems to correspond to an upward vertical movement of the furring strips. This was true for all insulations except for EPS. The movement of the EPS test panel demonstrated a reverse trend, where a drop in the RH resulted in an upward vertical movement of the furring strips.

The test conducted at 5 psf on the XPS sample demonstrated very stable performance with almost no movement seen in the sample even with changing temperature and RH.

From the test data, it is difficult to differentiate movements of the samples that result from prolonged loading (creep) or from environmental changes. Both positive as well as negative movements were noted. The movements from environmental changes are most likely caused by material expansion and contraction from moisture adsorption or thermal changes. Given the limited testing, the magnitude of this effect cannot be predicted at this point. In addition, material property changes may affect performance over the range of actual in-service temperatures. This was not accounted for in the testing. Additional testing of exterior samples exposed to a variety of temperature and humidity conditions is recommended.

2.3.5 Recommendations

The work conducted by NYSERDA/FSA used an initial deflection limit of 0.015 in. as a basis for design (Crandell 2010). By limiting the initial deflection to 0.015 in., the intent was to keep long-term deflection caused by potential creep of the system within acceptable limits, although these acceptable limits were not defined. As an actual ultimate design criteria, the initial 0.015-in. deflection limit (short-term) should not be confused with the in-service acceptable deflection (initial and long-term combined).

Based on experience, past research and testing, and the results of the laboratory work, a 1/64-in. deflection limit as an in-service standard is too conservative for most practical purposes. Such a small movement would not be able to be detected in board and siding installations. For other cladding such as adhered stone veneers and stucco, the initial deflection is not as significant an issue because the mortars have not been hydrated and the cladding is a viscous fluid (and not solid) when the initial movement takes place. Once the stucco and adhered stone veneers have cured, though, further movement may become a concern.

Acceptable deflection limits, then, need to be specific to the type of cladding. For lap sidings and panel claddings with joints (metal, vinyl, wood, and fiber cement), the movement is aesthetic in nature and not a health and safety issue. The acceptable amount of deflection will be a function of acceptable aesthetics for the cladding system chosen. For most lap siding or panel cladding systems, variations up to 1/16 in. or even 1/8 in. may be acceptable because the material and installation tolerances are easily greater than the potential gap development. As a result, it is recommended that the deflection be limited to 1/16 in. in service unless it is demonstrated that larger deflections can be tolerated.

For brittle claddings (such as stucco and cultured stone), movement could lead to cracking and potentially spalling of the material. For these systems it is recommended that the service deflection limit be set to prevent deflection that may damage the cladding or impair its function. For brittle claddings, a limit of 1/64 in. is proposed after initial deflection.

Most common residential cladding systems (metal, vinyl, wood, and fiber cement) are lightweight enough (<5 psf) that attachment to furring over any thickness of insulation does not create an issue. For these cladding systems the predicted deflection—based on a reasonable horizontal spacing (16-in. to 24-in. o.c.) and vertical fastener spacing (up to 24-in. o.c.)—is so slight (1/200 in.) and creep effects are so minimal that the deflection does not approach the proposed 1/16-in. maximum in-service limit.

For heavier cladding systems (>10 psf), initial deflection is within the proposed deflection limit. Information about potential thermal and moisture expansion and contraction movements, as well as creep effects of certain insulation materials in exposed environments, is inadequate for predicting long-term in-service deflection. Additional research into the long-term deflection movement of heavier claddings in exposed environments is needed.

3 Water Management Details

The use of exterior insulation has been a stumbling block for many designers and contractors. Even though the concept is simple, the details required to maintain continuity of the water management system can often be confusing.

At the most basic level there are two choices. The water management of the assembly is maintained by either placing the water resistive barrier (WRB) interior of the insulation or exterior of the insulation. The choice of where it will be applied is a complex one and requires consideration and weighing of many factors.

For the most part, placing the WRB to the exterior of the insulation has been the easier of the two approaches because the details are largely similar to standard construction practices. Concern is often raised about how to support elements that once were positioned in the structural frame wall, which are now “pushed” outward into the plane of the exterior insulation (e.g., windows and step flashings).

Conversely, placing the WRB inboard of the exterior insulation (see Figure 12) has been more difficult for contractors to adopt because of some significant departures from standard construction details and common construction sequences. These concerns increased when these techniques were applied to a building retrofit. This placement has benefits, however, in that the WRB is placed in a more protected location (increasing durability) and the window is located in the plane of the existing framing. With either choice, specific details are required to maintain the continuity of the WRB at the connection of the wall assemblies with other building elements such as foundations, roofs, porches, decks, windows, and doors.



Figure 12. Typical exterior retrofit detail, showing furring strip cladding attachment

Details were developed to serve as guidance on effectively maintaining the continuity of the water management. The matrix of details is broken down into two primary categories:

Wood framed wall construction

- Lap siding
- Building paper
- Board sheathing
- 2 × 4 wood studs
- Interior lath and plaster.

Mass masonry construction

- 3-wythe mass masonry wall
- ¾-in. vertical wood furring
- Interior lath and plaster.

A multitude of variations are possible but the BSC team felt that these two baseline assemblies were representative of housing structures that are currently targeted for energy retrofits. By extension, the details are not intended to cover all possible scenarios that a designer, contractor, or homeowner might encounter. Instead, they are intended to inform and guide choices by illustrating and discussing the intended goals of the retrofit.

3.1 Exterior Insulation Materials

The primary focus of this research is to examine the installation of exterior rigid insulation. Exterior rigid insulation material is generally separated into four product categories³:

- Foil-faced PIC
- XPS
- EPS
- Rigid mineral fiber (fiberglass or rockwool).

Exterior insulation can be installed in a single or multiple layers (see Figure 13). The number of layers will depend on the overall amount of insulation in the design and the available product thicknesses. Installations 2 in. and less will typically be done in a single layer. Installations greater than 2 in. are more commonly done in multiple layers. When multiple layers are used, BSC recommends offsetting the joints both horizontally and vertically to minimize the effects that gaps at the board edges may have on the thermal performance of the insulation.

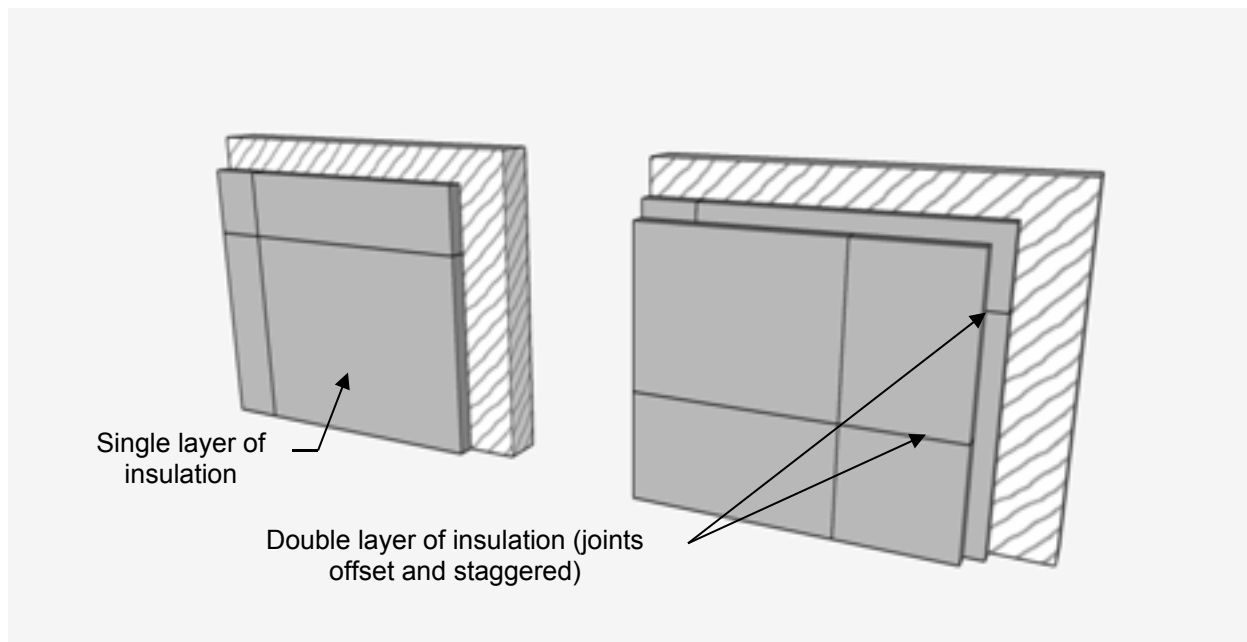

Figure 13. Layering patterns of exterior insulation

³ The authors of this research also acknowledge and support the use of exterior closed cell spray polyurethane foam as an exterior insulation approach. This approach is not discussed in this document because it was outside the scope of this research.

3.2 Water Resistive Barrier

The WRB is generally located either between the insulation and the wall structure or to the exterior of the insulation behind the cladding. A third option of placing the WRB in between two layers of insulation is also possible, but this is uncommon and can lead to significant confusion and coordination problems during construction. Although the third option can be used, it generally does not create any significant advantages that would justify the problems it might cause. The choice of the location of the WRB will affect many other enclosure connection details. The strategy should be clear and consistent throughout the entire project.

The most common WRBs in the residential market today are building or house wraps, which are mechanically attached using nails or staples. Although fully adhered air barrier membranes (which can often perform the functions of a WRB) have been widely used in the commercial market, they have only recently become more common in residential construction. Manufacturers are developing and marketing residential-grade versions (permeable and impermeable) of these self-adhered membranes.

Another application that is becoming more prevalent is using liquid applied membranes that are sprayed, rolled, or brushed onto the exterior sheathing. Finally, using exterior insulation products as WRBs is becoming more and more popular. Many manufacturers currently have ICC Evaluation Service approvals for their products to be listed as WRBs. Of the insulation products mentioned previously, only foil-faced PIC and XPS are currently recommended for use as WRBs through taping and sealing of the joints with sheathing or other compatible construction tape or self-adhered membrane flashing. This is an important consideration when choosing an insulation product and water management strategy. With thinner insulation thicknesses, adding a building wrap over top of the insulation can allow the drainage plane of the assembly to be placed to the exterior of any of the insulation products listed previously. As the insulation thickness increases, the placement of the building wrap becomes less practical because long cap nails or staples would be required to attach the wrap before the furring can be installed. For these assemblies the use of the insulation as the WRB is usually more practical.

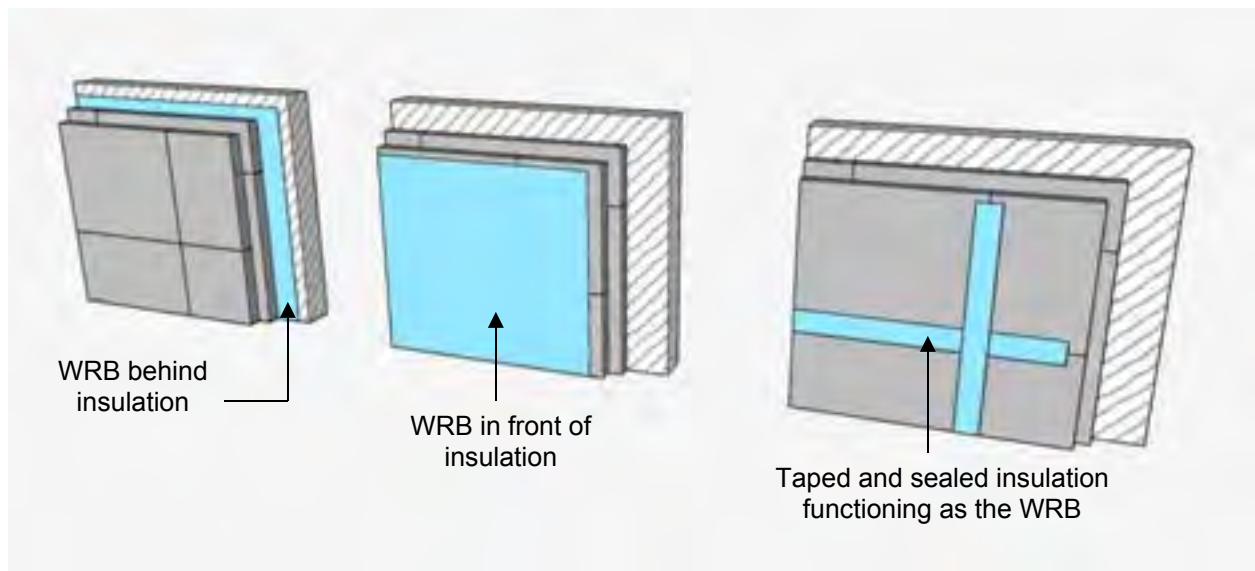

Figure 14. WRB options with exterior insulation

3.3 Air Barrier

As part of an exterior insulation retrofit of a building, some consideration should also be given to improving the airtightness of the building. With exterior retrofits, it is often convenient to integrate an exterior air barrier system as part of the design (see Figure 15). There are significant advantages to this placement of the air barrier, with the greatest being simplified continuity (no disruption at partition walls or floor separations). As such, the details developed also include air barrier continuity issues, though the exact strategy is kept generic. For the purposes of this research, the air barrier has been placed at the interface between the existing structural wall and the exterior insulation. This is the recommended placement of the air barrier for these types of wall assemblies, although BSC recognizes that other possibilities exist.

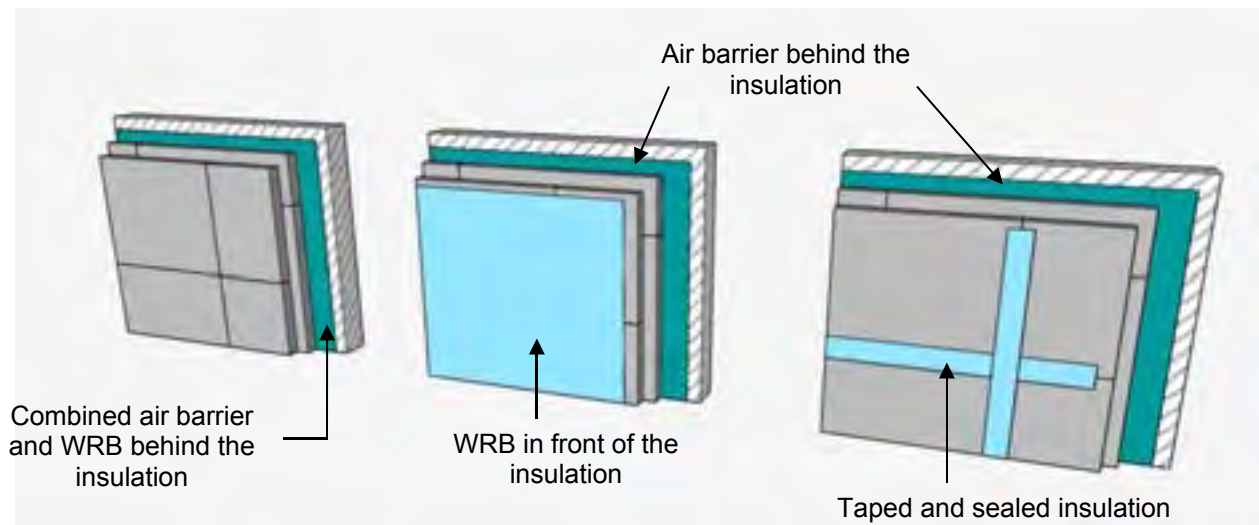

Figure 15. Recommended air barrier location for retrofit assemblies

3.4 Cladding Attachment

The cladding must always be attached by some means back to the primary structure. For thinner insulation thicknesses, it may be possible to directly fasten the cladding through the insulation back to the structure. The practical thickness limit is around 1.5 in. for most wood and fiber cement siding materials and 2 in. for vinyl siding. This limit is based on the availability of fasteners of sufficient length. Most siding guns will have an upper limit of around 3 to 3½ in. for nails.

As a result, it has been a common practice for many years to use furring strips fastened back through the insulation with screws as the cladding attachment mechanism. Using furring strips has other enclosure benefits such as better drainage from behind the cladding and increased drying of the assembly.

Mass masonry walls need to be handled in a slightly different way because of practical limitations of available masonry anchors and anchor installations. Although it is not impossible, using masonry screws to attach the furring back to a masonry structure through thick levels of insulation is often considered to be impractical because most masonry screws require predrilling

of a pilot hole in the masonry. Powder-actuated fasteners are not recommended for use with the insulation in place because they can damage the insulation material. The recommended approach is to attach 2 × 4 wood studs on the flat directly to the masonry wall before installing the insulation (see Figure 16). The 2 × 4 studs then serve as the anchor location for the furring strips.

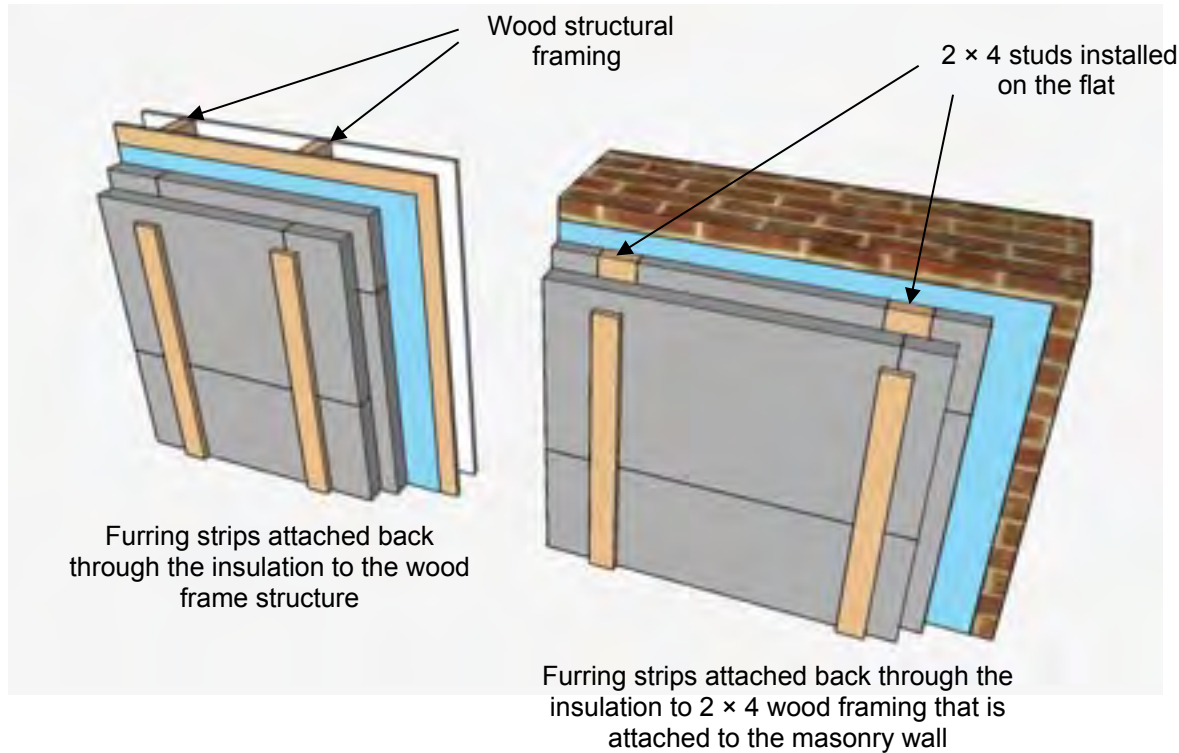

Figure 16. Recommended cladding attachment design

3.5 Window Integration

Integrating the installation of exterior insulating with window assemblies will depend on the window details. The best case scenario is that the window systems are being replaced at the same time that the insulation is being installed on the exterior of the building. With this scenario, it can be fairly simple to integrate the water management details of the windows with the wall assemblies. In some cases, the windows are not intended to be replaced for some time, or not intended to be replaced at all. In either case, integrating the exterior insulation may pose a few more design challenges.

3.5.1 Replacement Window Details

With window replacement, the location of the window in the plane of the wall is often driven by aesthetics. It is common to desire or require maintaining the exterior appearance of older wood sided homes. In this case, the placement of the window will tend to be out in the field of the insulation so that traditional exterior trim dimensions can be maintained. This approach also creates deeper interior sills that many people enjoy. This window placement strategy is colloquially called an “outie” window.

On the other end of the spectrum, windows may also be placed in line with the existing structure, an approach colloquially known as an “innie” window. This placement can help to maintain existing interior trim, but does result in deeper exterior trim returns.

The placement of the window does not need to dictate the placement of the WRB (or the other way around), but there are certain detailing benefits associated with maintaining simple planes of water management. With outie windows, it is easy to integrate the frame with the WRB when the WRB is located at the front face of the insulation. This combination of window location and WRB avoids the need for complicated wrapping and changes in plane of the WRB at a critical enclosure interface. By keeping the details simple, the overall risk of problems developing is greatly reduced. This does not mean that other combinations should not be undertaken, because proper detailing and appropriate material and product use can also reduce risk. In fact, with certain materials such as liquid applied membranes, the risks involved with complicated geometries of the substrate are practically eliminated, allowing for greater design flexibility.

3.5.2 Integration With Existing Windows

With existing windows,⁴ extant conditions can create some integration challenges. Older single-glazed wood windows are still common in many areas. These windows may be desired to be maintained for various reasons, and multiple strategies can be employed to improve their performance. Similarly, in some cases, windows have already been replaced during previous retrofits to the home and are not currently planned for replacement as part of the exterior insulation retrofit.

The integration details for the exterior insulation with existing windows were developed with the intention that the windows might be replaced in the future or that their replacement might be planned as a separate phase to the exterior insulation retrofit. For this reason, the details were developed to allow the windows to be replaced at some point without disturbing the installation of the exterior insulation.

Mass masonry walls pose an additional challenge for maintaining existing windows. Most windows in mass masonry walls are set back in the first wythe of the masonry rough opening. This geometry creates a potential for flanking losses of the thermal insulation. To address this, insulation needs to be returned into the rough opening and connected as closely as possible to the window frame. Where the existing windows have wide jambs and head trim, the space may be readily available. Where the trim is thinner, installing insulation at the returns can be more difficult. Products that are designed to accommodate such concerns are currently on the market. High thermal resistance insulations with a rated R-value of R-10/in. (such as aerogel insulations) would be appropriate to use in instances where the limited space may compromise the desired thermal performance.

A secondary concern with mass masonry wall occurs at the window sills. For existing wood windows, there is inadequate space to allow even high thermal resistance products to be used. In

⁴ Note that without removal of the window system, existing water and air infiltration conditions may lead to durability concerns with the enclosure. Furthermore, when changes to the enclosure are made (such as increasing airtightness and adding thermal insulation), previous conditions that might not have degraded the enclosure’s performance can sometimes become a concern. The individuals integrating these details are responsible for ensuring that no other concerns are preexisting with the building.

these locations, the masonry sill should be removed (see Figure 17). The exposed area can then be grouted to create a smooth surface that is positively sloped to the exterior. Subsequently, the area is covered with a membrane flashing that is integrated into the WRB of the wall assembly. The removal of the sill masonry or stone then provides adequate space to return the insulation to the window frame.

Masonry sill removed to allow for the insulation to return back to the window frame

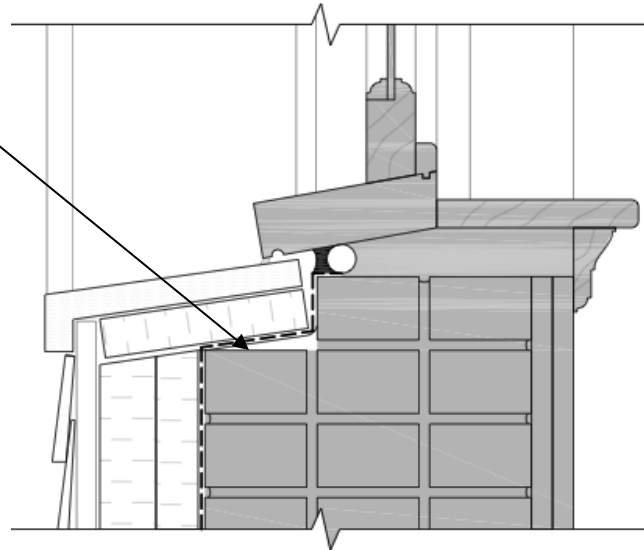

Figure 17. Detail of masonry sill removal to allow for insulation to return to the window frame

3.6 Roof Integration

Several common roof to wall conditions may be encountered (see Figure 18).

- Upper roof to lower wall (all attic types)
- Upper wall to lower roof (vented attic or porch)
- Upper wall to lower roof (unvented attic)

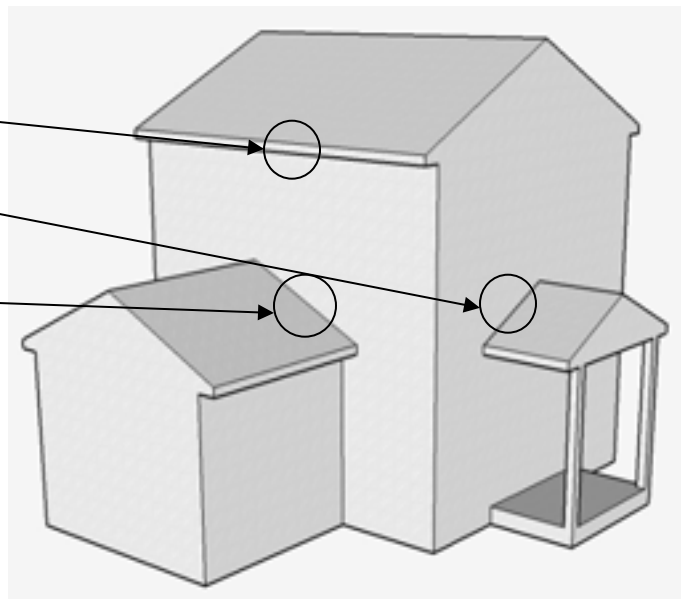

Figure 18. Common roof to wall connections

At the upper roof to lower wall condition, the termination of the exterior insulation does not change significantly whether the attic is vented or unvented. The differences would mostly be associated with the attic design and not the wall design.

Where an upper wall intersects a lower roof, the termination details are critical and will depend greatly on the design of the attic below. For vented attics or porch roofs, the intent is to maintain the continuity of the insulation past the roofline because the wall above and the continuation of the wall below the roof are both considered exterior wall assemblies.

From an airtightness perspective, what is known as a “chain-saw” retrofit is the most effective way to address this detail. In this case, the roof or porch are physically cut from the building, allowing the exterior insulation and air barrier (if part of the design) to run continuous past the roofline. The roof or porch structure is then reattached or independently supported and flashed back into the water management strategy of the building. Alternately, the roof structure may be left in place and the insulation installed from above and below the existing roofline. This creates greater risk of air leakage and requires more careful detailing of the air barrier system.

For unvented attics, the location of the insulation and the air barrier will also affect the details. For these roof to wall connections a chain-saw retrofit will not provide any additional benefit because the plane of the insulation and airtightness follows the roofline.

In all cases, flashing of the roof to wall interface is critical for maintaining the continuity of the water management system. The location of the roof flashing will depend on the selected location of the WRB of the wall assembly (Figure 19).



Figure 19. Different drainage plane placement for exterior insulation retrofits

If the WRB is designed to be behind the exterior insulation, the step flashing and shingles must extend back to the plane of the exterior wood sheathing or masonry wall. A consideration for the detailing of this interface is the future need to replace the roof of the building. The roof covering will undoubtedly have a shorter service life than the wall cladding. For this reason, a way to access the roof to wall interface behind the exterior insulation should be provided so that future work can be completed without disrupting the primary siding installation. A minimum 8-in. band

of siding and insulation is recommended for installation at the roof to wall interface. This band creates a removable termination to allow for future access to the flashing at the roof to wall interface (sequence shown in Figure 20). The band has a secondary benefit as an easy detail for installing a kick-out flashing if the end of the roof terminates in the field of the wall.

Step 1:

Install self-adhered membrane flashing at the roof to wall interface.

Install kick-out flashing at the edge of the roof.

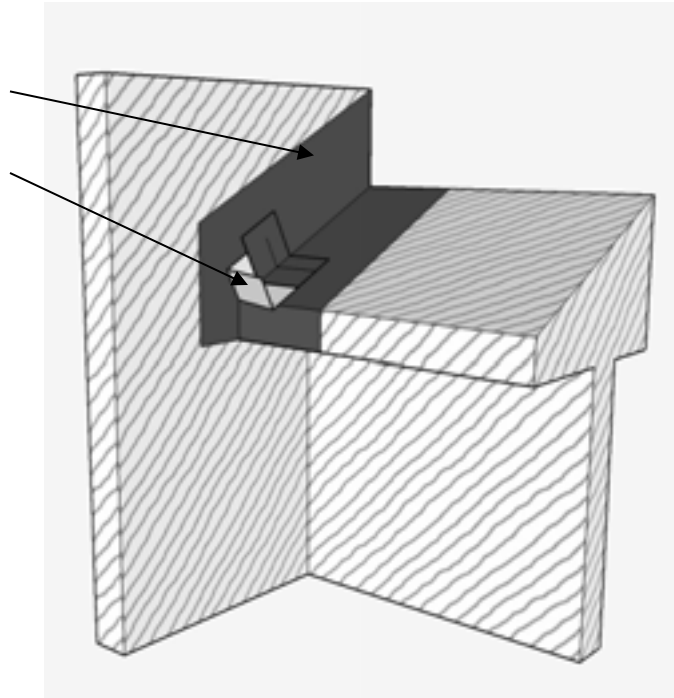

Step 2:

Install the roof covering and step flashing following standard roofing practice.

Shingle lap the top edge of the step flashing with the wall WRB or strip in additional membrane flashing.

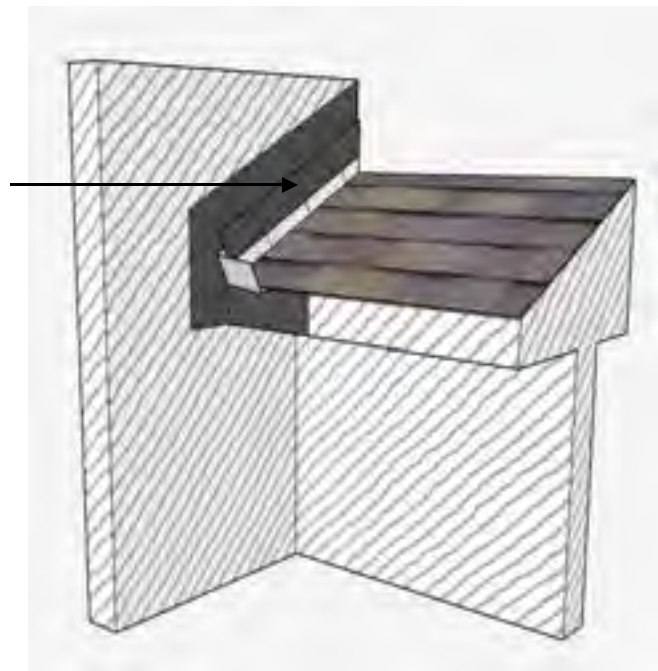

Step 3:

Install insulation over the wall area.

Construct an 8-in. gap along the roofline.

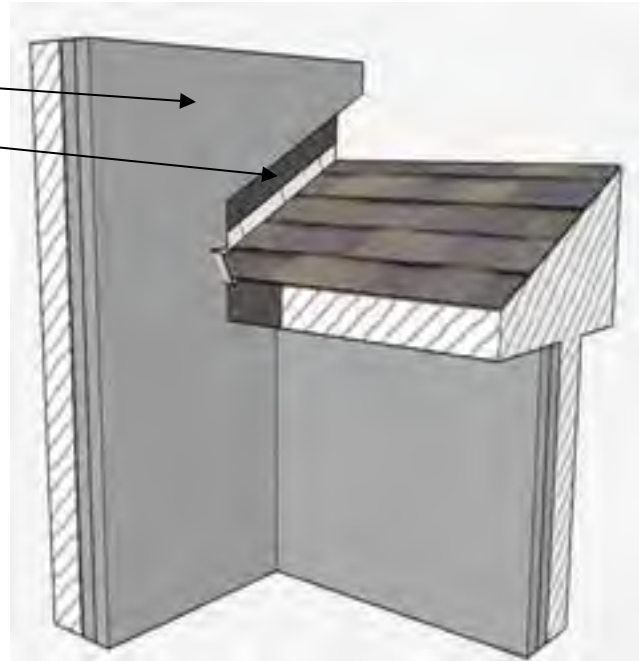

Step 4:

Fill the 8-in. gap with a strip of insulation that can be removed later to allow for access to the step flashing during replacement of the lower roof.

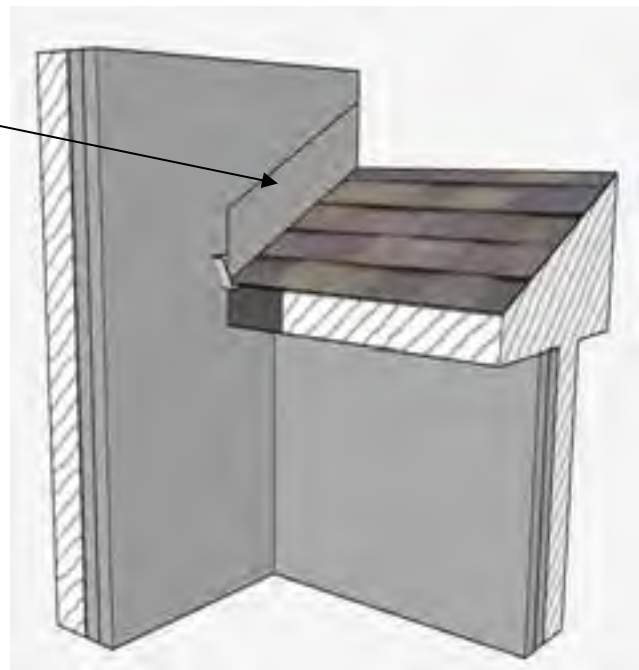

Figure 20. Roof to wall interface with WRB behind the insulation

If the WRB is designed to be placed at the face of the exterior insulation, more standard roofing details can be used. BSC still recommends providing the trim band for access to the roof to wall interface, although it is no longer as critical. Attaching the step flashing can be accomplished using longer nails that can penetrate through the insulation back to the wall sheathing. As the insulation thicknesses increase, this becomes less practical. As an alternative, a strip of OSB or

plywood can be added to the front of the insulation and covered with a self-adhered membrane flashing. This plywood or OSB strip would then serve as the nail base for the step flashing, resulting in a more conventional installation. The construction sequence is likely to be the single greatest challenge that a builder will face with this approach. Roof coverings are installed as soon as possible to protect the building from rain infiltration. The concern is that the detail requires the wall insulation to be in place before the roof is installed. This has created problems on several retrofit projects. A solution to this is to install a strip of wall insulation (that is temporarily flashed back to the wall sheathing) at the roof to wall connection to allow the roof to be installed independently of the wall system (sequence shown in Figure 21). This requires preplanning and coordination during construction.

Step 1:

Install an air barrier transition membrane and insulation at the roof to wall interface.

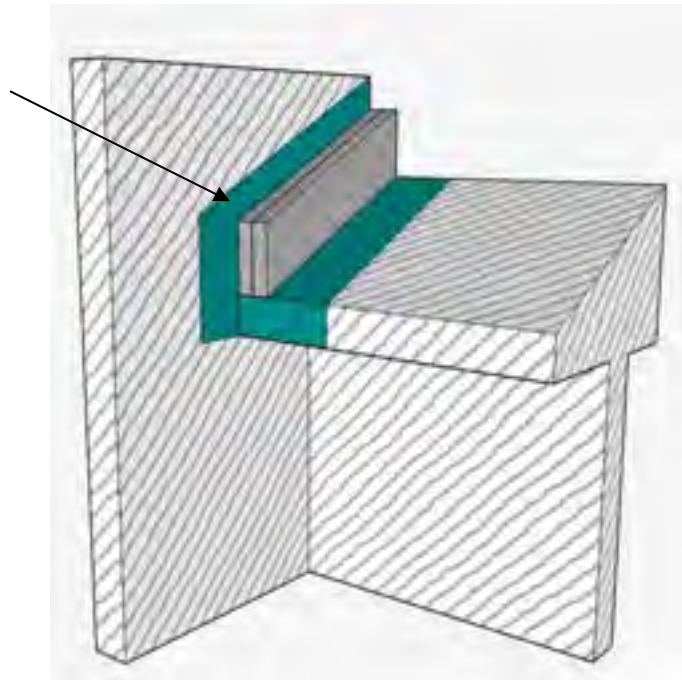

Step 2:

Install a self-adhered membrane that extends from the roof deck, up and over the insulation, and connects to the wall sheathing (this step temporarily waterproofs the roof to wall connection during the construction process).

Install kick-out flashing at the roof edge.

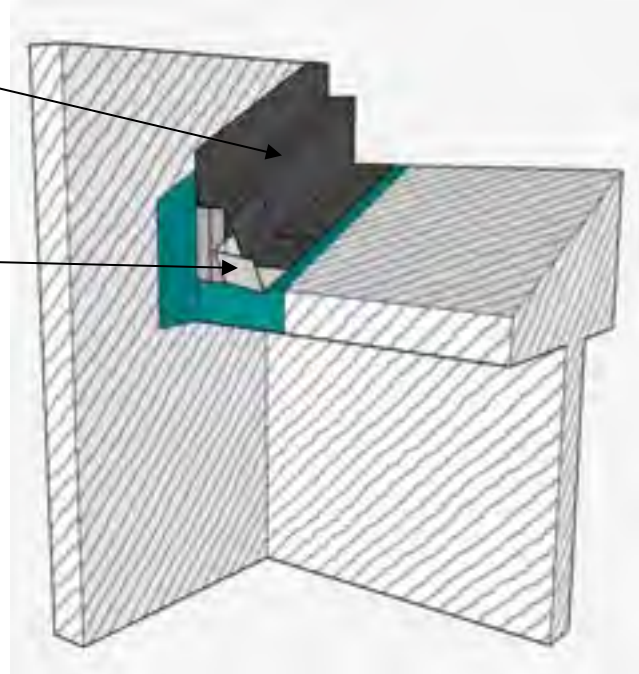

Step 3:

Install the roof covering and step flashing following standard roofing practice.

Strip in the top edge of the step flashing with additional membrane flashing.

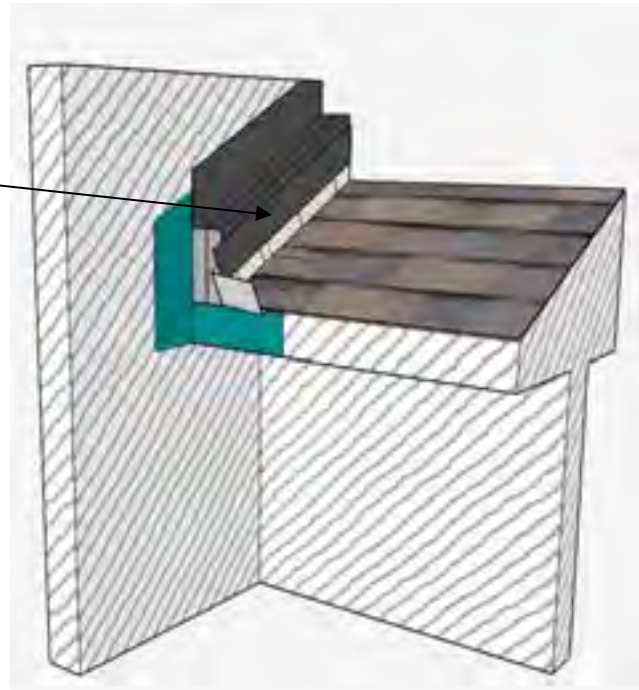

Step 4:

Install insulation over the wall area.

Shingle lap the joint at the curb with the wall WRB or strip in additional membrane flashing.

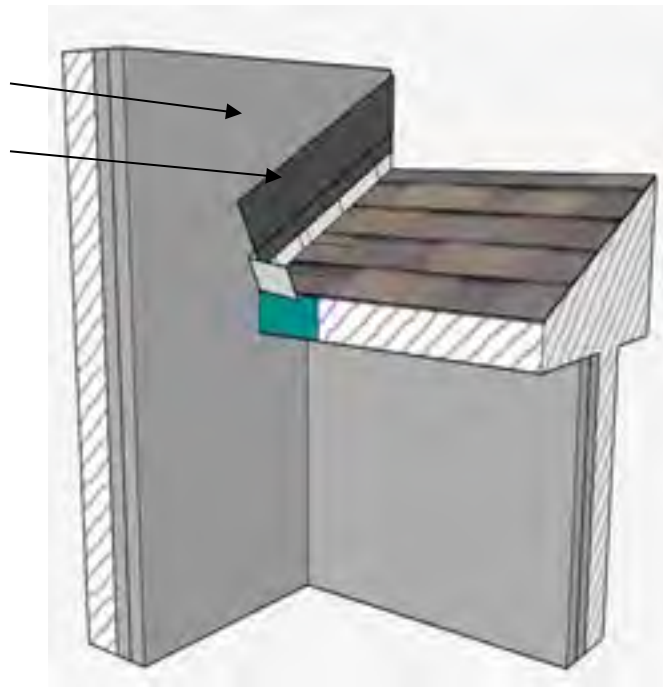

Figure 21. Roof to wall interface with WRB at the face of the insulation

3.7 Balcony Integration

Balconies (or decks where the drainage is on top of the structure) are most similar to upper wall to lower roof interfaces. Again, separating the balcony from the structure to allow the insulation and the air barrier to run continuous past the edge of the balcony will maintain the best continuity of the thermal insulation and the air barrier. In many cases, however, the balconies are part of the building structure, either through cantilevered wood framing members or cast concrete as is the case with many masonry buildings. In these situations, cutting and removing the balcony may not be feasible.

Wood framed balconies are more easily handled than concrete balconies. If the balcony cannot be separated from the building, insulating above and below can often sustain suitable continuity. Because of the high conductivity of concrete, the most challenging situation is likely to be the cast concrete balcony.

3.8 Deck Integration

Similar to upper wall to lower roof interfaces with vented attics and porch roofs, the best approach from a thermal and air barrier continuity perspective is to use a chain-saw retrofit approach with framed decks. In this case, the deck is physically cut from the building, allowing the exterior insulation and air barrier (if part of the design) to run continuous past the deck line. The deck structure is then reattached or independently supported and flashed back into the water management strategy of the building. As an alternative, the deck structure may be left in place and the insulation installed from above and below the existing roofline. This creates greater risk of air leakage and requires more careful detailing of the air barrier system.

4 Conclusions

In this research project, BSC developed baseline engineering analysis to support the installation of thick layers of exterior insulation on existing masonry and frame walls. Water management details necessary to integrate windows, doors, decks, balconies, and roofs were also created to serve as guidance for integrating exterior insulation strategies with other enclosure elements. The details give consideration to complete retrofit as well as phased retrofit approaches. These connection details allow for future integration with other high performance enclosure system elements.

BSC determined that acceptable deflection instead of ultimate capacity of the systems governed the design. For lap sidings and panel claddings with joints (metal, vinyl, wood, and fiber cement), movement is aesthetic in nature and not a health and safety issue. The acceptable amount of deflection will be a function of acceptable aesthetics for the cladding system chosen. For most lap siding or panel cladding systems, variations up to 1/16 in. or even 1/8 in. may be acceptable because the material and installation tolerances are easily greater than the potential gap development. BSC recommends, therefore, that the deflection be limited to 1/16 in. in service unless it is demonstrated that larger deflections can be tolerated.

For brittle claddings (such as stucco and cultured stone), movement could lead to cracking and potentially spalling of the material. For these systems BSC recommends that the service deflection limit be set to prevent deflection that may damage the cladding or impair its function. A limit of 1/64 in. is proposed after initial deflection for brittle claddings.

Most common residential cladding systems (metal, vinyl, wood, and fiber cement) are lightweight enough (<5 psf) that attachment to furring over any thickness of insulation is not problematic. For these cladding systems, the predicted deflection based on a reasonable horizontal spacing (16- to 24-in. o.c.) and vertical fastener spacing (up to 24-in. o.c.), is so slight (1/200 in.) and creep effects are so minimal that the predicted deflection does not approach the proposed 1/16-in. maximum in-service deflection limit.

For heavier cladding systems (>10 psf) initial deflection is within the proposed deflection limit. There is, however, inadequate information about potential thermal and moisture expansion and contraction movements, as well as creep effects of certain insulation materials in exposed environments. This lack of information makes predicting long-term in-service deflections difficult. Additional research into the long-term deflection movement of heavier claddings in exposed environments is needed.

Integrating exterior insulation into the water management strategy of the building takes careful detailing at interfaces with other enclosure elements.

For the most part, placing the WRB to the exterior of the insulation has been easiest because the details are largely similar to standard construction practices. Concern is often raised about a way to support elements that were once positioned in the structural frame wall, which are now “pushed” outward into the plane of the exterior insulation (e.g., windows and step flashings).

Conversely, placing the WRB inboard of the exterior insulation has been more difficult for contractors to adopt because of some significant departures from standard construction details

and common construction sequences. These concerns increased when these techniques were applied to a building retrofit. This WRB placement, however, has benefits. The WRB is placed in a more protected location (increasing durability), and the window can be located in the plane of the existing framing.

As part of this work, BSC developed details to serve as guidance on effectively maintaining the continuity of the water management strategy. These details are presented in Appendix A of this report.

References

- AF&PA (2005). *National Design Specification (NDS) for Wood Construction*. American Forest & Paper Association, Washington, DC. www.awc.org/standards/nds.html
- AF&PA (1999). *General Dowel Equations for Calculating Lateral Connection Values: Technical Report 12*. American Forest & Paper Association, Washington, D.C. www.awc.org/standards/nds.html
- BSC (2010). *Building America Annual Report: 8.1 Westford Habitat for Humanity Prototype House, Westford, MA*. Somerville, MA: BSC.
- BSC (2009a). *Building America Annual Report: D.2 HFH of Greater Lowell, Farmhouse Renovation, Bedford, MA*. Somerville, MA: BSC.
- BSC (2009b). *Building America Annual Report: D.4 "Lot 26" – Meadows at Cumberland Ridge, Dowingtown, PA*. Somerville, MA: BSC.
- Crandell, J.H. (2010). *Task 3 Report: Develop a Prescriptive Table for Attaching Cladding to Framing over Continuous Insulation and Develop a Code Proposal*. SFA and NYSERDA. New York City, NY
- Hutcheon, N.B. (1964). "Principles Applied to an Insulated Masonry Wall." *NRC-IRC (National Research Council of Canada-Institute for Research in Construction) Canadian Building Digest (CBD-50)*. Ottawa, ON: National Research Council of Canada.
- Joyce, D. (November 2009). "Retrofitting Exterior Insulation." *Journal of Light Construction*., Accessed August 10, 2011 from <http://www.jlconline.com/building-envelope/retrofitting-exterior-insulation.aspx>
- Lstiburek, J.W. (2007). "Building Sciences: The Perfect Wall." *ASHRAE Journal* (50:May); pp. 74–78.
- Lstiburek, J.W. (2009). "Building Sciences: Building in Extreme Cold." *ASHRAE Journal* (51:February); pp. 56–59.
- Lstiburek, J.W. (2010). "Building Sciences: Mind the Gap, Eh!" *ASHRAE Journal* (52:January); pp. 57–63.
- Pettit, B. (2009). "Deep Energy Retrofit of a Sears Roebuck House: A Home for the Next 100 Years." *High Performing Buildings* (2:Spring).
- Reed Construction Data (2011). *RSMeans CostWorks 2011, 15th Annual Edition*. Norwell, MA: Reed Construction Data.
- Straube, J.F.; Smegal, J. (2009). *Building America Special Research Project – High-R Walls Case Study Analysis*. BA-0903. Accessed October 21, 2013. <http://www.buildingscience.com/documents/bareports/ba-0903-building-america-special-research-project-high-r-walls/view>
- Ueno, K. (2010). "Residential Exterior Wall Superinsulation Retrofit Details and Analysis." *Performance of the Exterior Envelopes of Whole Buildings XI*. Atlanta, GA: ASHRAE.
- U.S. Department of Energy, Energy Information Administration (2008). *Annual Energy Review 2007*. DOE/EIA-0384(2007). Washington, DC: Energy Information Administration.

Appendix A: Water Management Details

<p>Exterior Insulation over Wood Frame Wall Drainage Plane at Face of Insulation</p> <p>W1-Ra Vented Attic to Wood Frame Wall - A W1-Rb Unvented Attic to Wood Frame Wall - B W1-Rc Unvented Attic to Wood Frame Wall - C W1-Rd Unvented Attic to Wood Frame Wall "Chain Saw" - D</p> <p>W1-RWa Vented Attic to Wood Frame Wall - A W1-RWb Unvented Attic to Wood Frame Wall - B W1-RWc Unvented Attic to Wood Frame Wall - C W1-RWd Vented Attic to Wood Frame Wall "Chain Saw" - D</p> <p>W1-Ba Balcony Over Unconditioned Space to Wood Frame Wall - A W1-Bb Balcony Over Conditioned Space to Wood Frame Wall - B W1-Bc Balcony Over Unconditioned Space to Wood Frame Wall "Chain Saw" - C</p> <p>W1-Da Deck to Wood Frame Wall - A W1-Db Deck to Wood Frame Wall "Chain Saw" - B W1-Dc Deck to Wood Frame Wall - C W1-Dd Deck to Wood Frame Wall "Chain Saw" - D</p> <p>W1-WHOa Window Head at Wood Frame Wall - "Outie" W1-WSOa Window Sill at Wood Frame Wall - "Outie" W1-WJOa Window Jamb at Wood Frame Wall - "Outie"</p> <p>W1-WHOb Window Head at Wood Frame Wall - "Innie" W1-WSOb Window Sill at Wood Frame Wall - "Innie" W1-WJOb Window Jamb at Wood Frame Wall - "Innie"</p> <p>Exterior Insulation over Wood Frame Wall Drainage Plane at Face of Wood Frame</p> <p>W2-Ra Vented Attic to Wood Frame Wall - A W2-Rb Unvented Attic to Wood Frame Wall - B W2-Rc Unvented Attic to Wood Frame Wall - C</p> <p>W2-RWa Vented Attic to Wood Frame Wall - A W2-RWb Unvented Attic to Wood Frame Wall - B W2-RWc Unvented Attic to Wood Frame Wall - C</p> <p>W2-Ba Balcony Over Unconditioned Space to Wood Frame Wall - A W2-Bb Balcony Over Conditioned Space to Wood Frame Wall - B</p> <p>W2-Da Deck to Wood Frame Wall - A W2-Db Deck to Wood Frame Wall - B</p> <p>W2-WH Window Head at Wood Frame Wall W2-WS Window Sill at Wood Frame Wall W2-WJ Window Jamb at Wood Frame Wall</p> <p>W2-WHl Window Head at Wood Frame Wall - "Innie" W2-WSl Window Sill at Wood Frame Wall - "Innie" W2-WJl Window Jamb at Wood Frame Wall - "Innie"</p>	<p>Exterior Insulation over Mass Masonry Wall Drainage Plane at Face of Insulation</p> <p>M1-Ra Vented Attic to Masonry Wall - A M1-Rb Unvented Attic to Masonry Wall - B M1-Rc Unvented Attic to Masonry Wall - C M1-Rd Unvented Attic to Masonry Wall "Chain Saw" - D</p> <p>M1-RWa Vented Attic to Masonry Wall - A M1-RWb Unvented Attic to Masonry Wall - B M1-RWc Unvented Attic to Masonry Wall - C M1-RWd Vented Attic to Masonry Wall "Chain Saw" - D</p> <p>M1-Ba Balcony Over Unconditioned Space to Masonry Wall - A M1-Bb Balcony Over Conditioned Space to Masonry Wall - B M1-Bc Balcony Over Unconditioned Space to Masonry Wall "Chain Saw" - C</p> <p>M1-Da Deck to Masonry Wall - A M1-Db Deck to Masonry Wall "Chain Saw" - B M1-Dc Deck to Masonry Wall - C M1-Dd Deck to Masonry Wall "Chain Saw" - D</p> <p>Exterior Insulation over Mass Masonry Wall Drainage Plane at Face of Masonry</p> <p>M2-Ra Vented Attic to Masonry Wall - A M2-Rb Unvented Attic to Masonry Wall - B M2-Rc Unvented Attic to Masonry Wall - C</p> <p>M2-RWa Vented Attic to Masonry Wall - A M2-RWb Unvented Attic to Masonry Wall - B M2-RWc Unvented Attic to Masonry Wall - C</p> <p>M2-Ba Balcony Over Unconditioned Space to Masonry Wall - A M2-Bb Balcony Over Conditioned Space to Masonry Wall - B</p> <p>M2-Da Deck to Masonry Wall - A M2-Db Deck to Masonry Wall - B</p> <p>M2-WH Window Head at Masonry Wall M2-WS Window Sill at Masonry Wall M2-WJ Window Jamb at Masonry Wall</p>	
 <p>bsc</p> <p><small>COPYRIGHT © 2011 BUILDING SCIENCE CORPORATION</small></p>	<p>Exterior Insulation over Wood Frame Wall and Mass Masonry Wall Detail List</p> <p>Date: 2012-03-05</p>	<p>Sheet Title: Index</p>

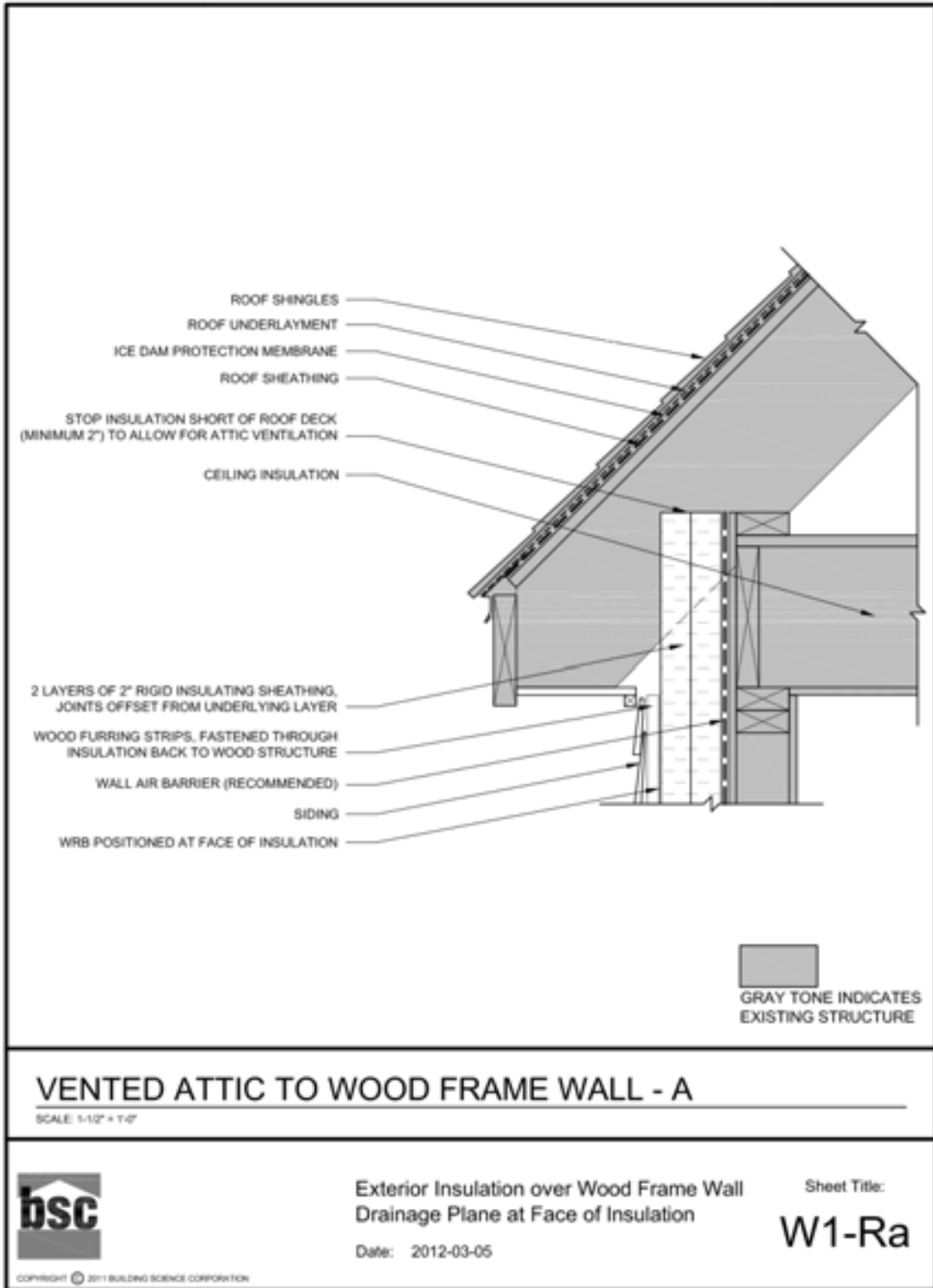

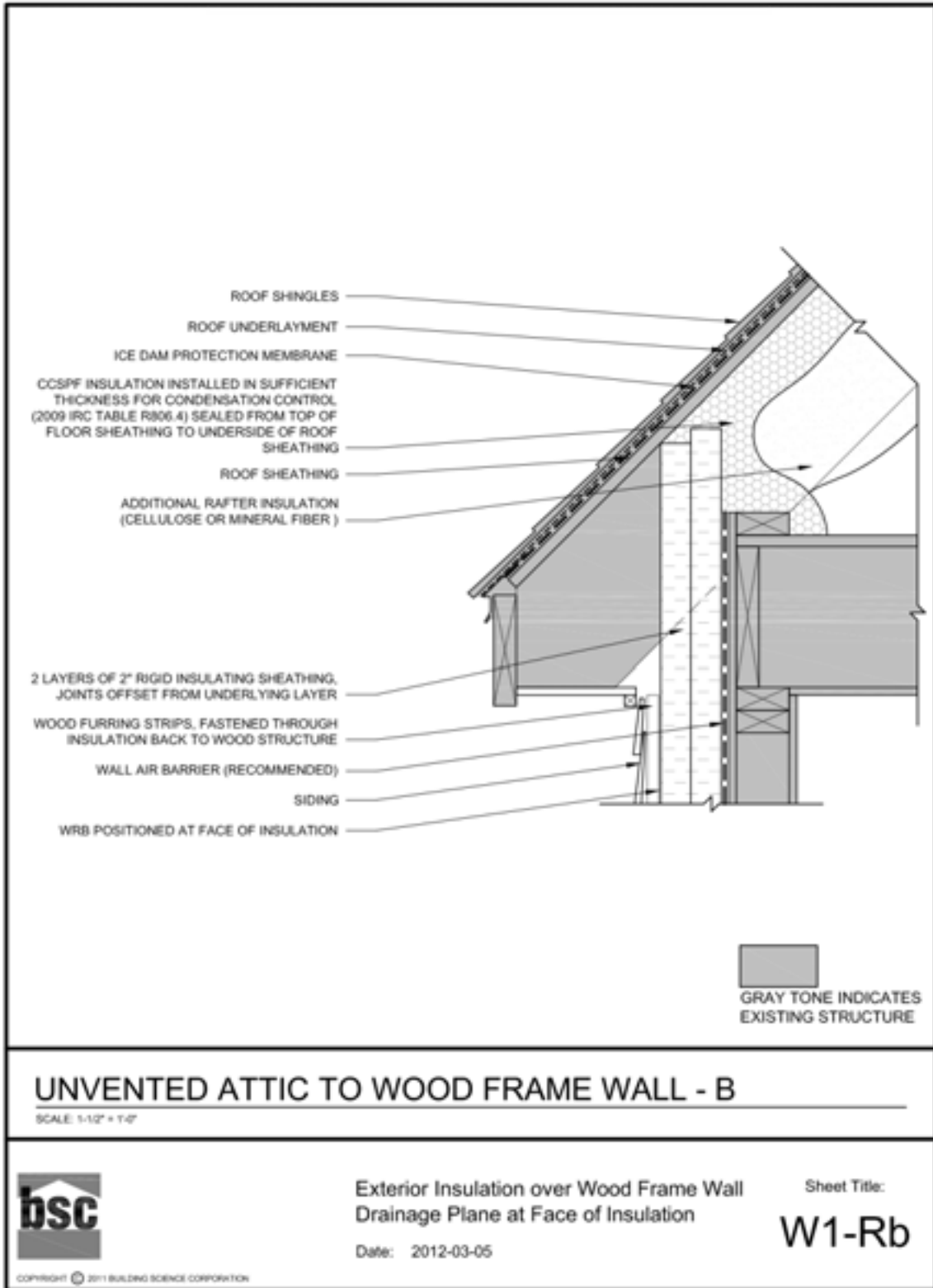

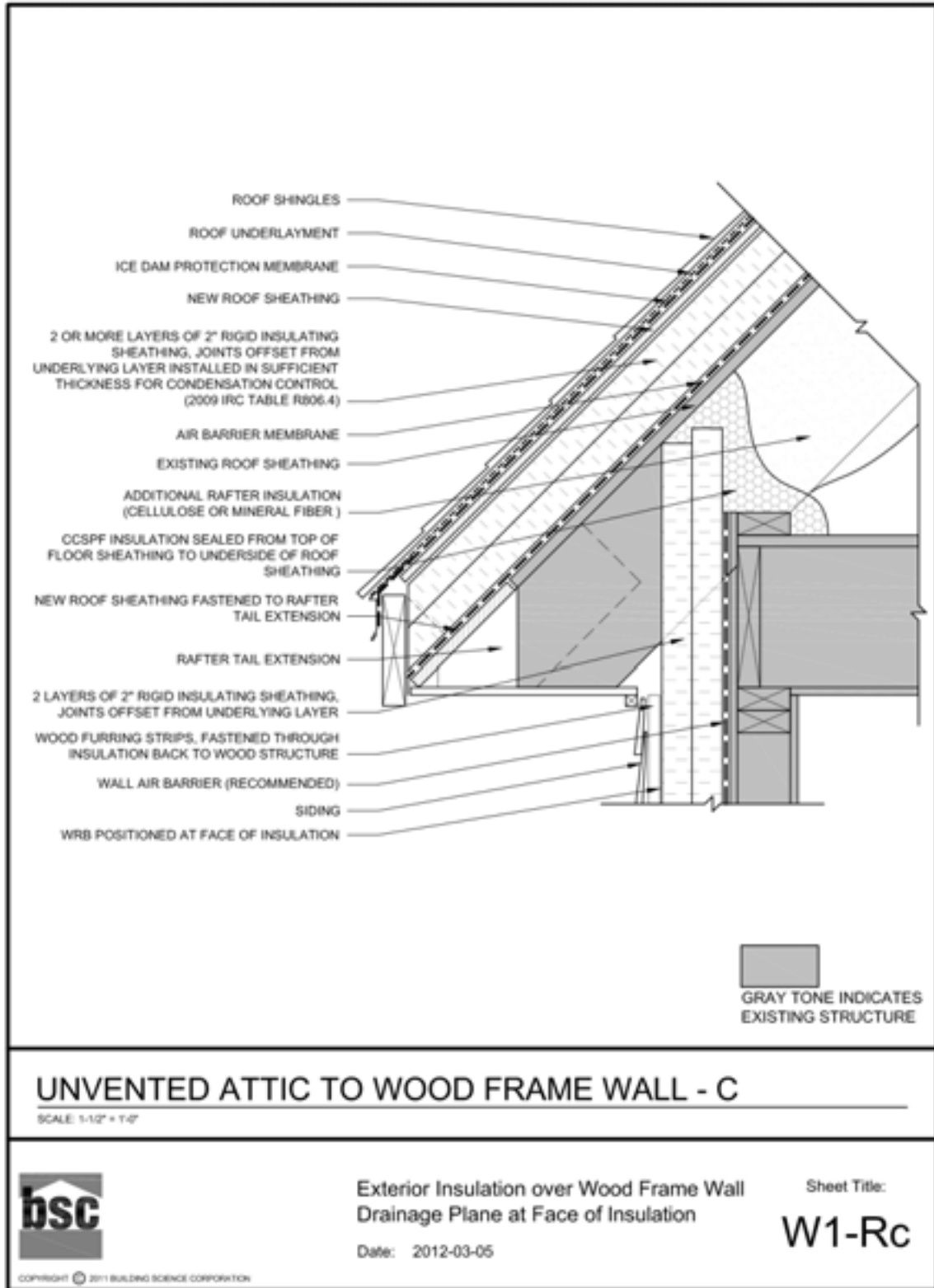

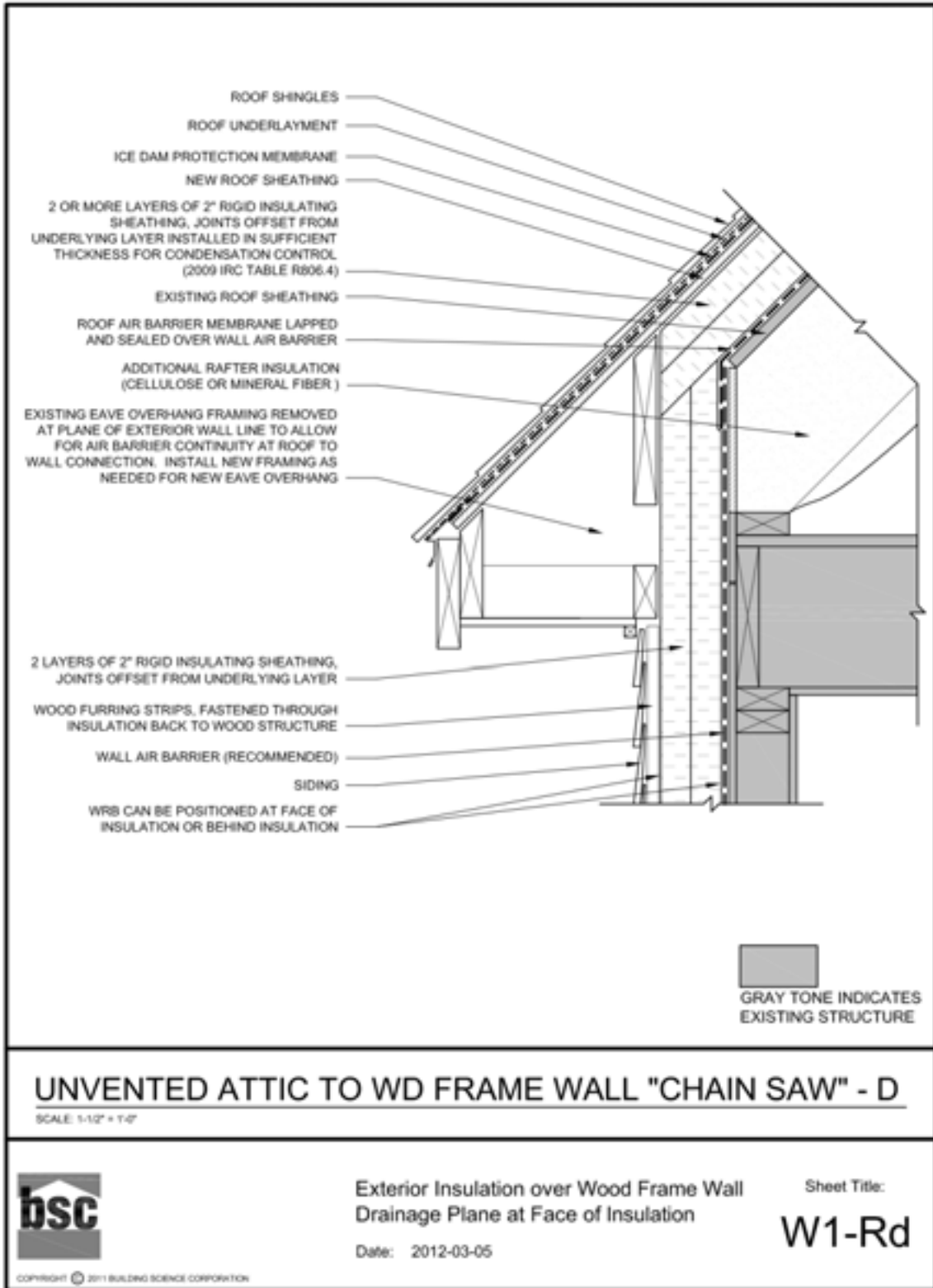

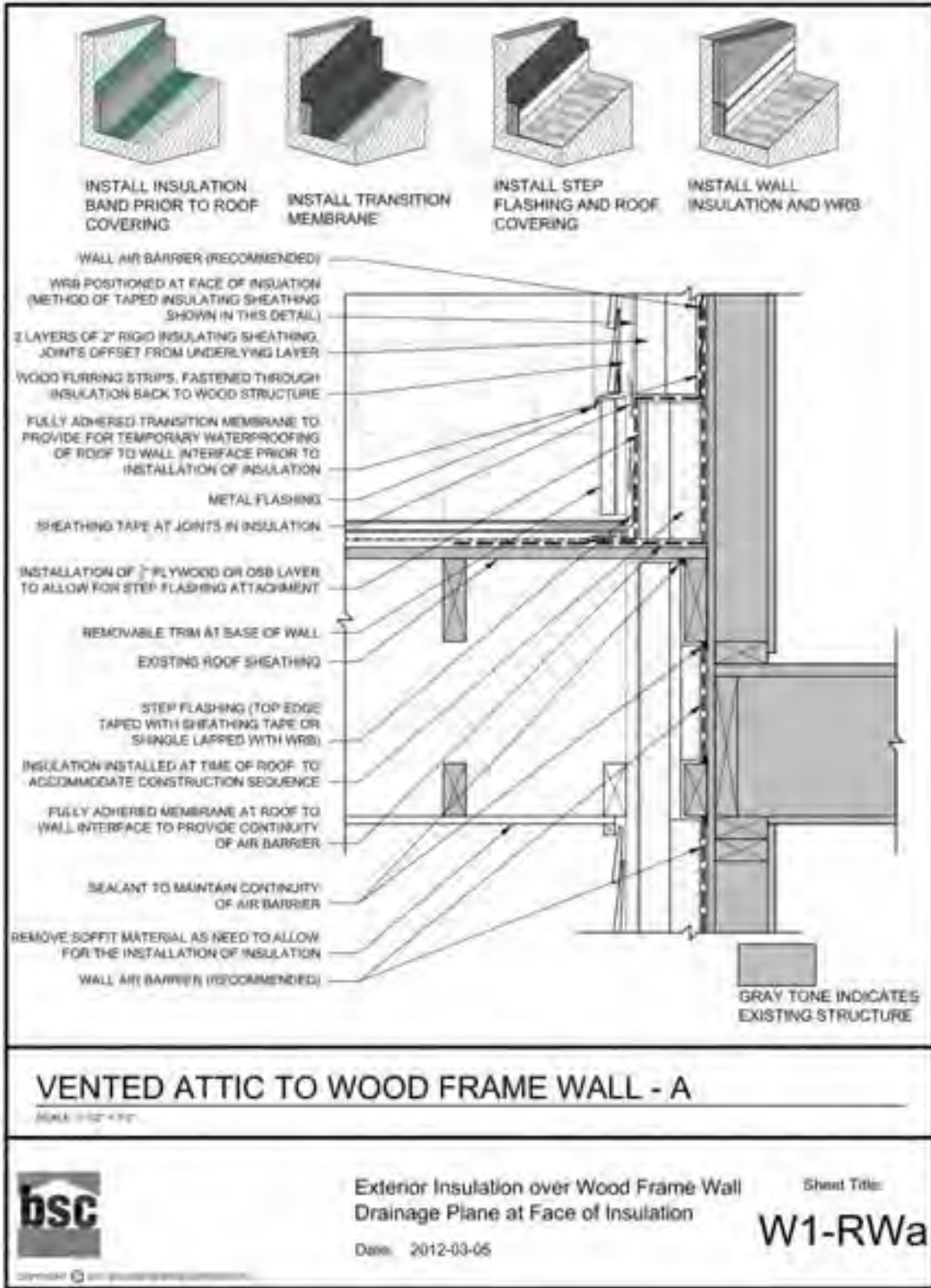

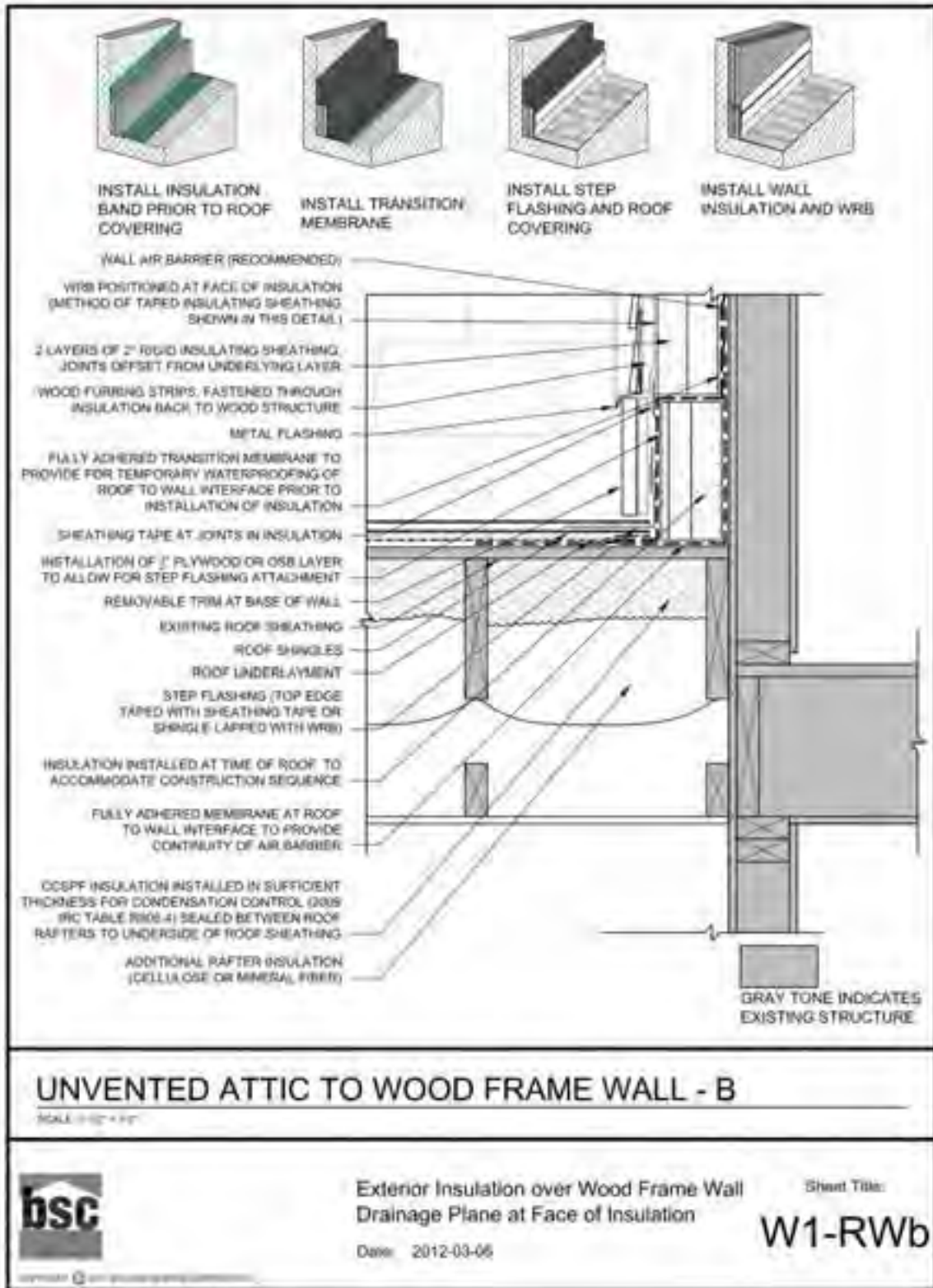

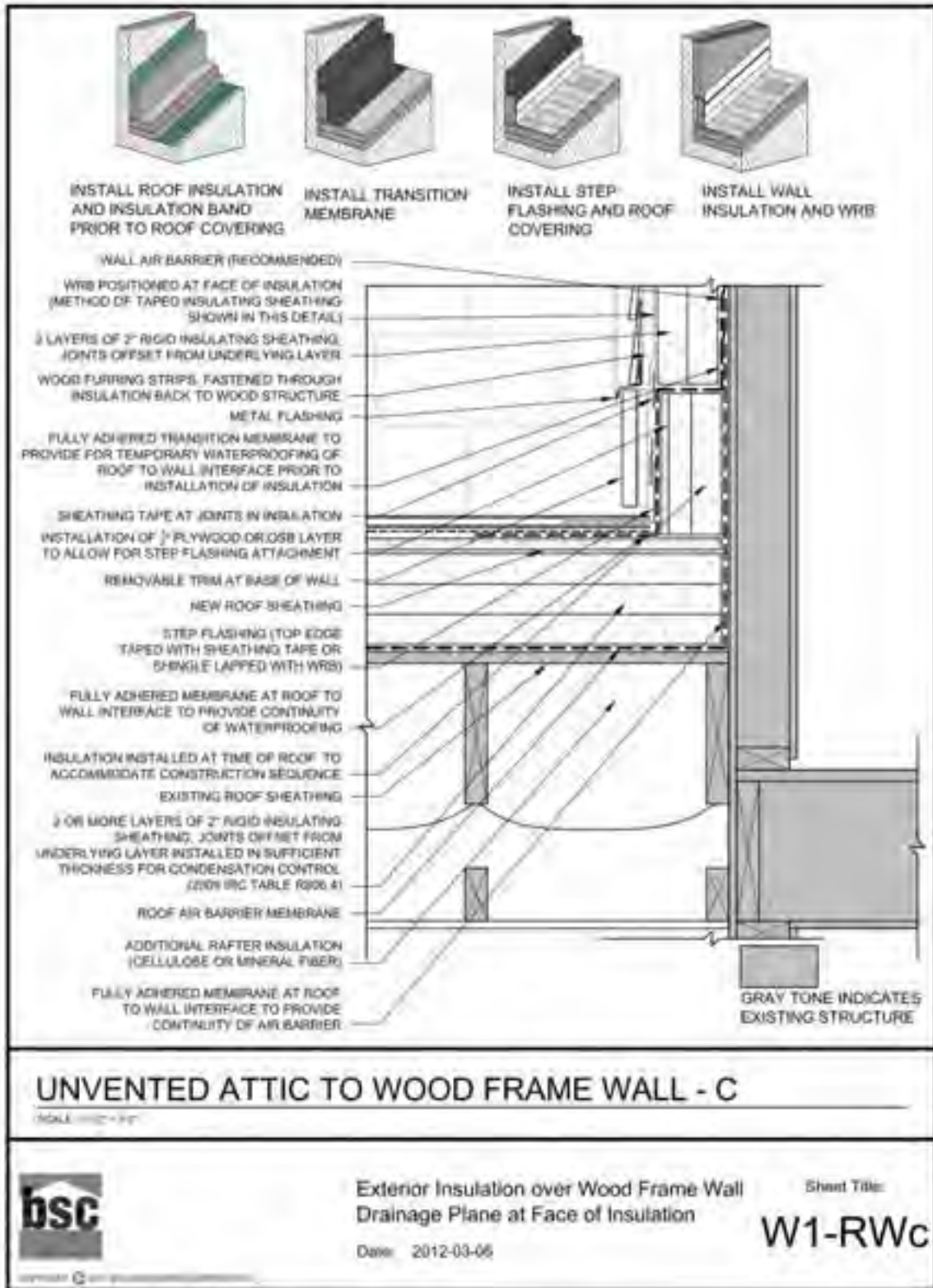

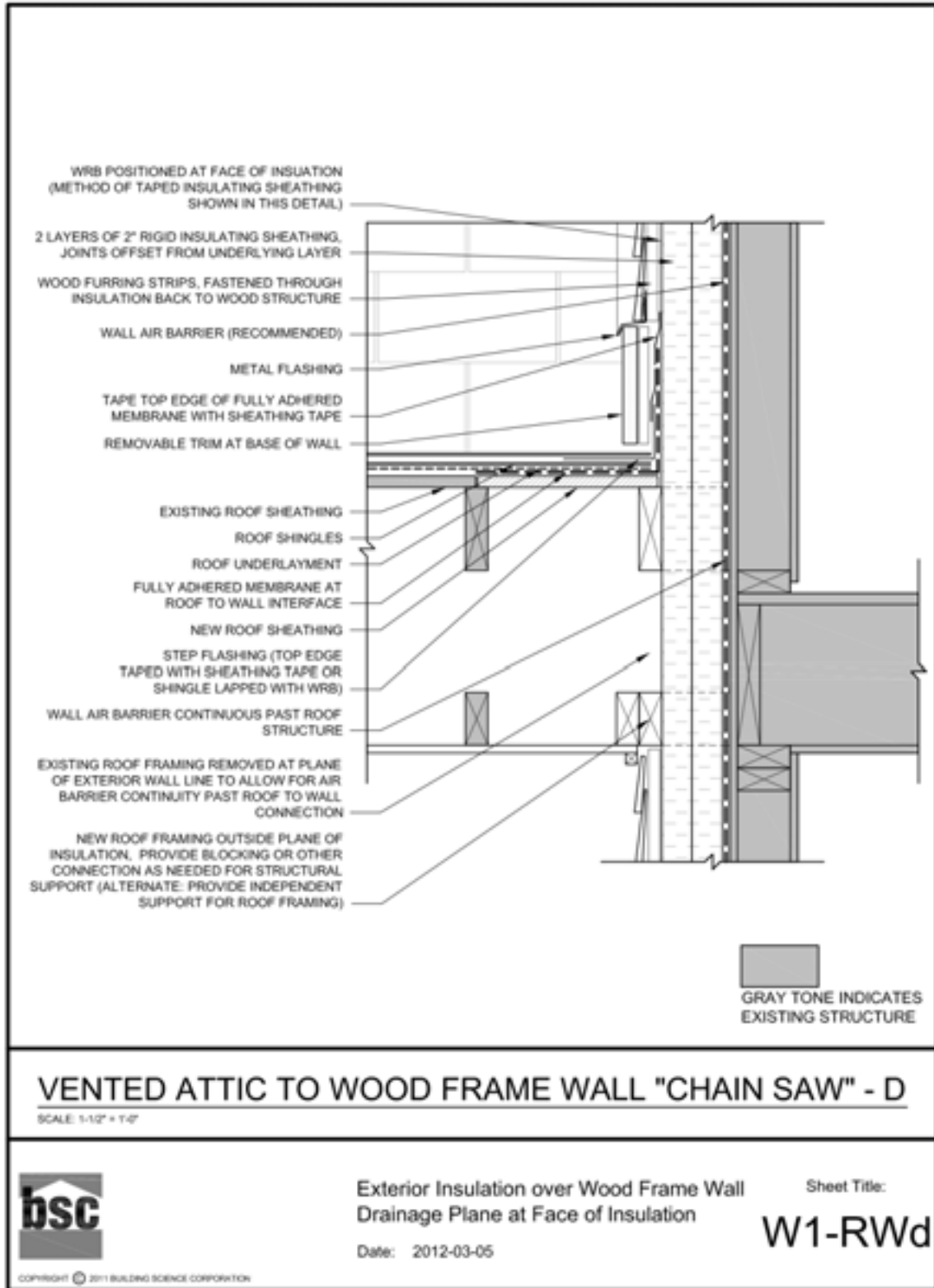

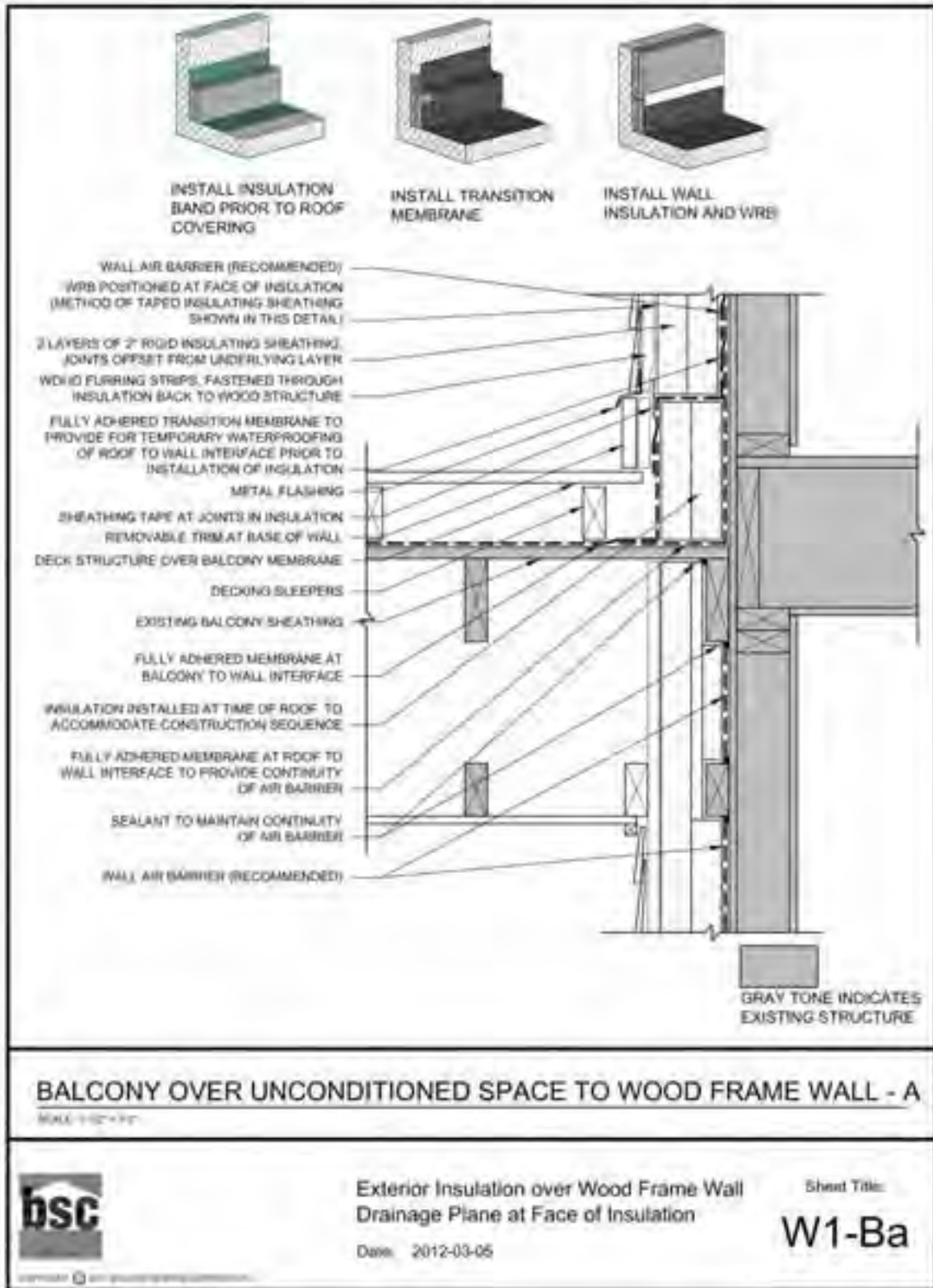

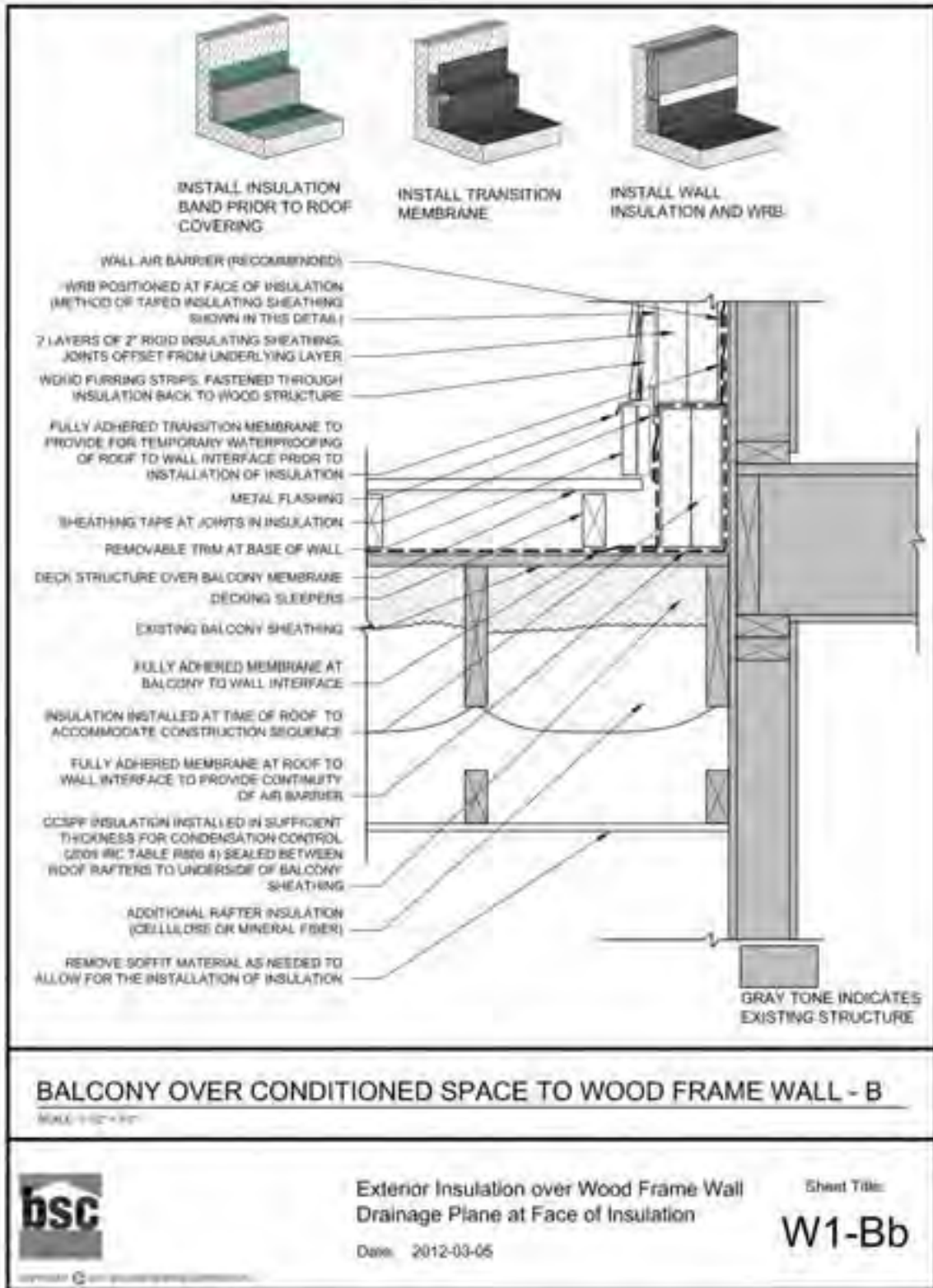

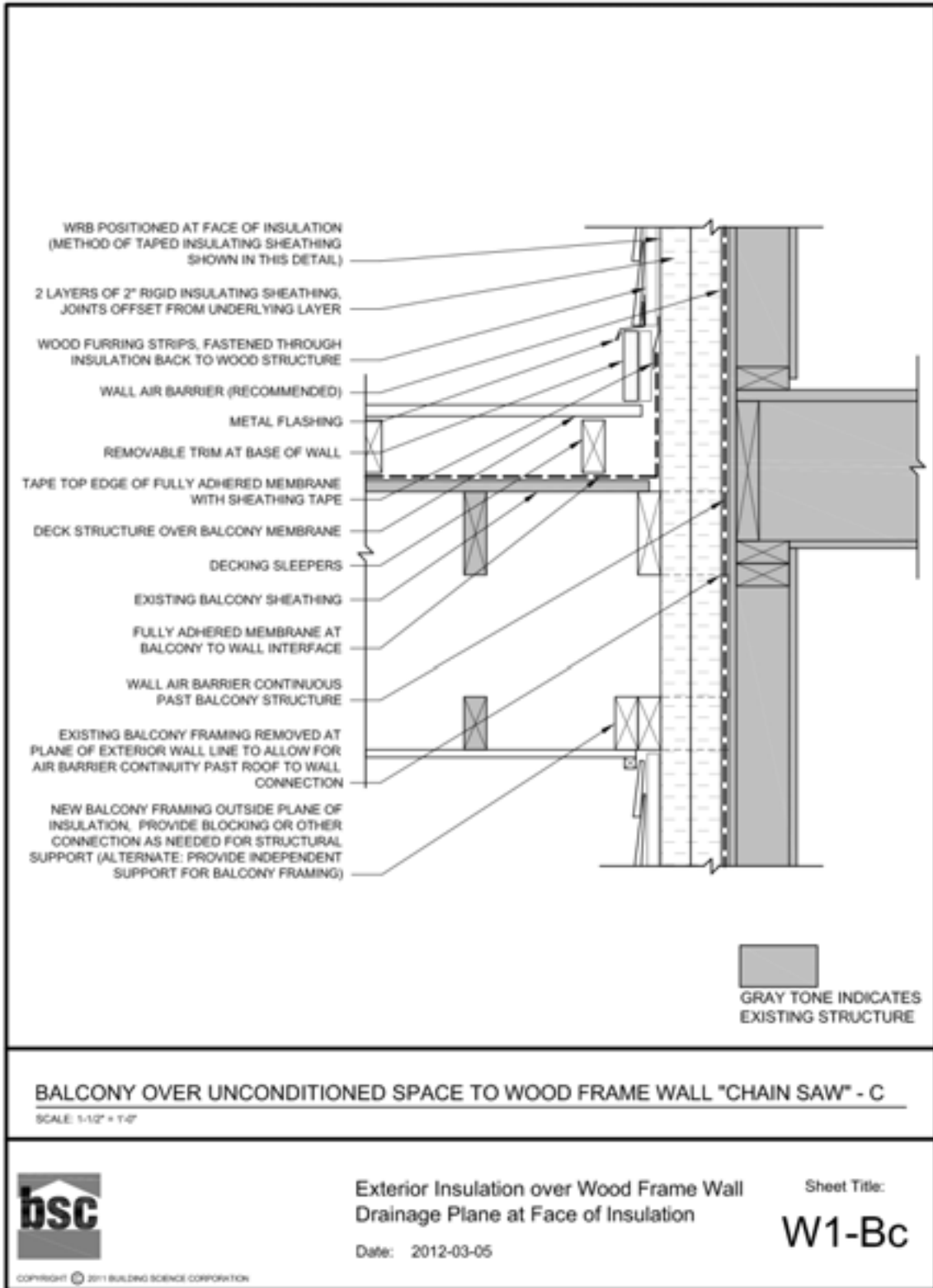

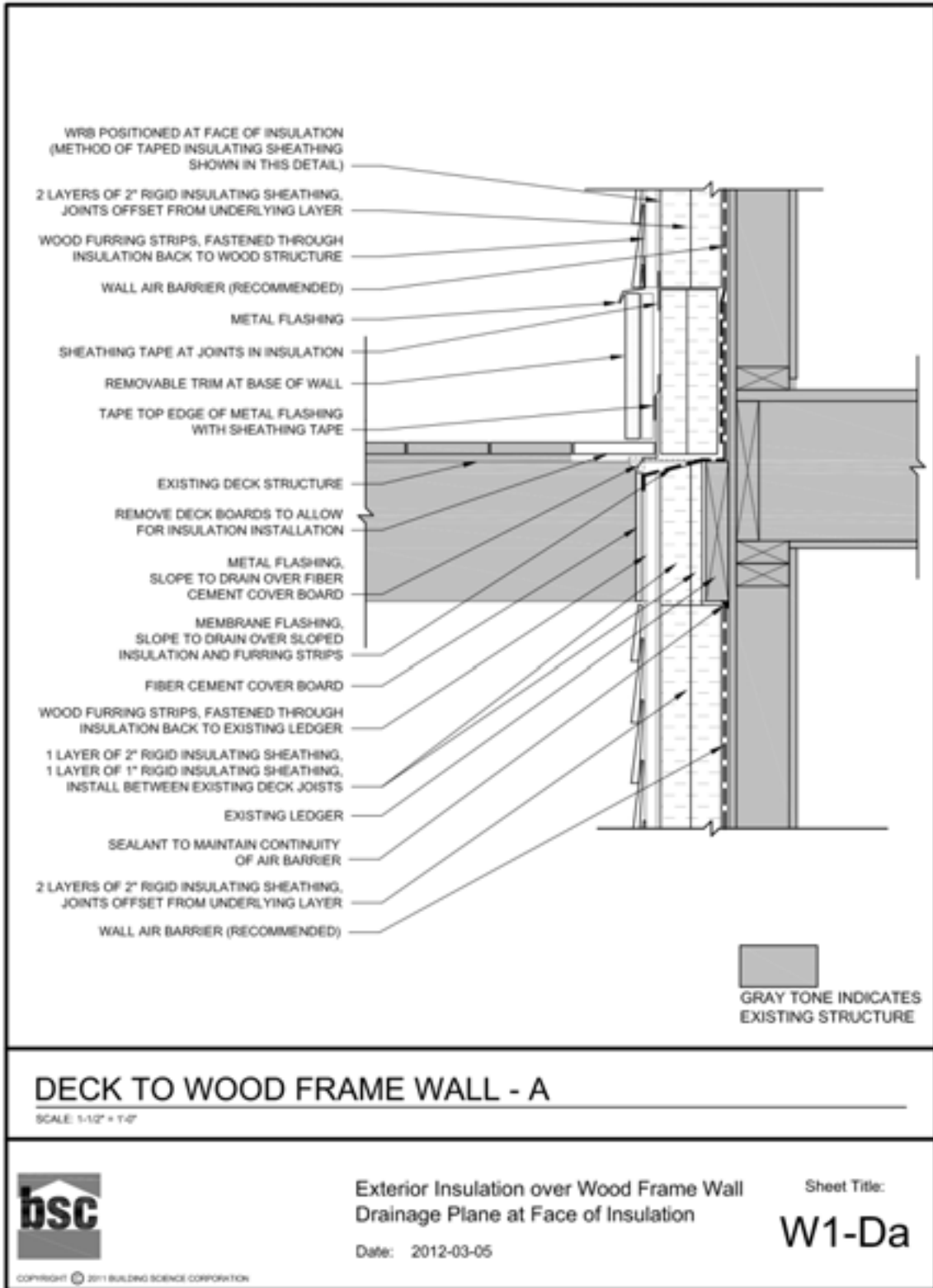

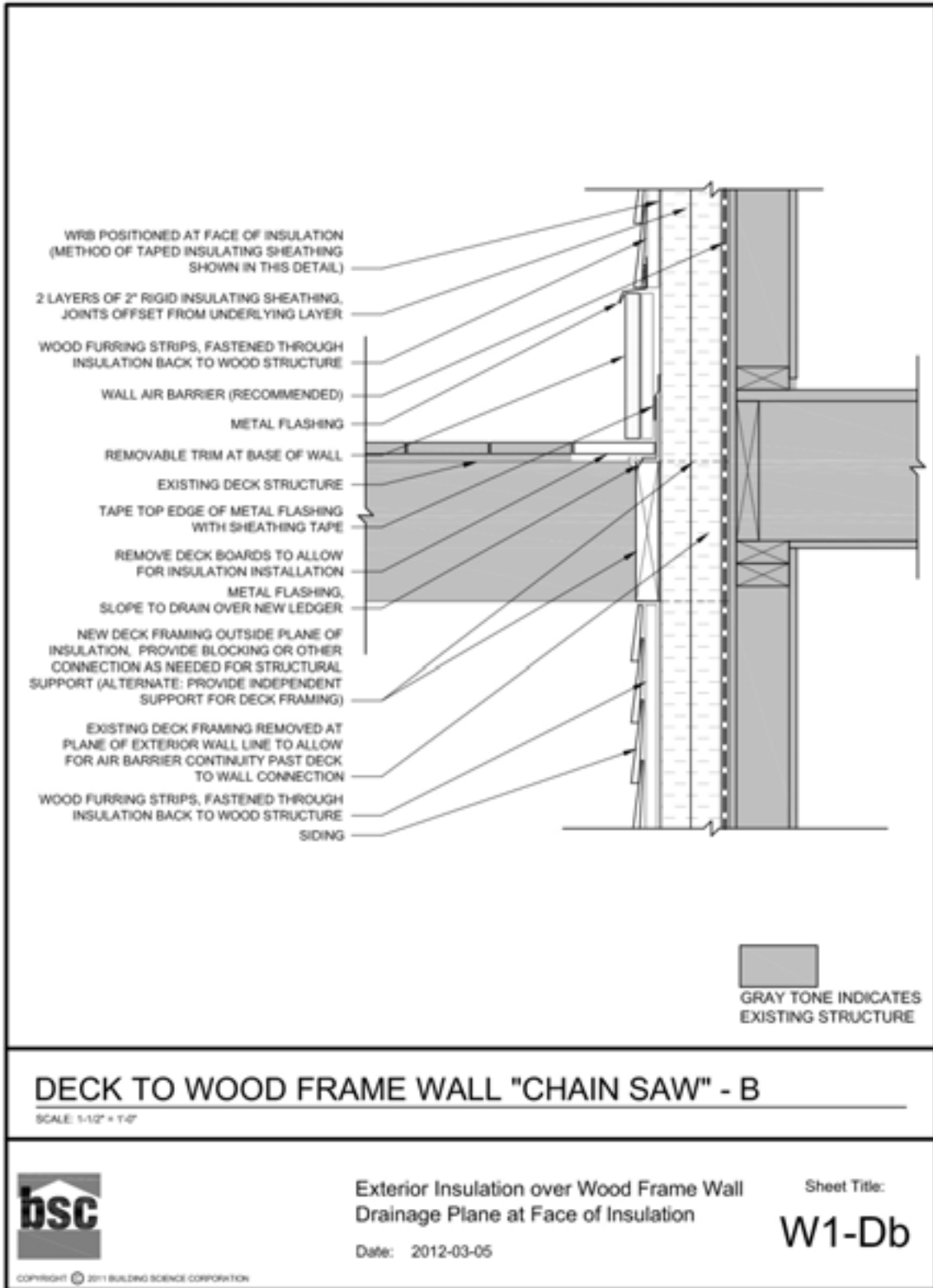

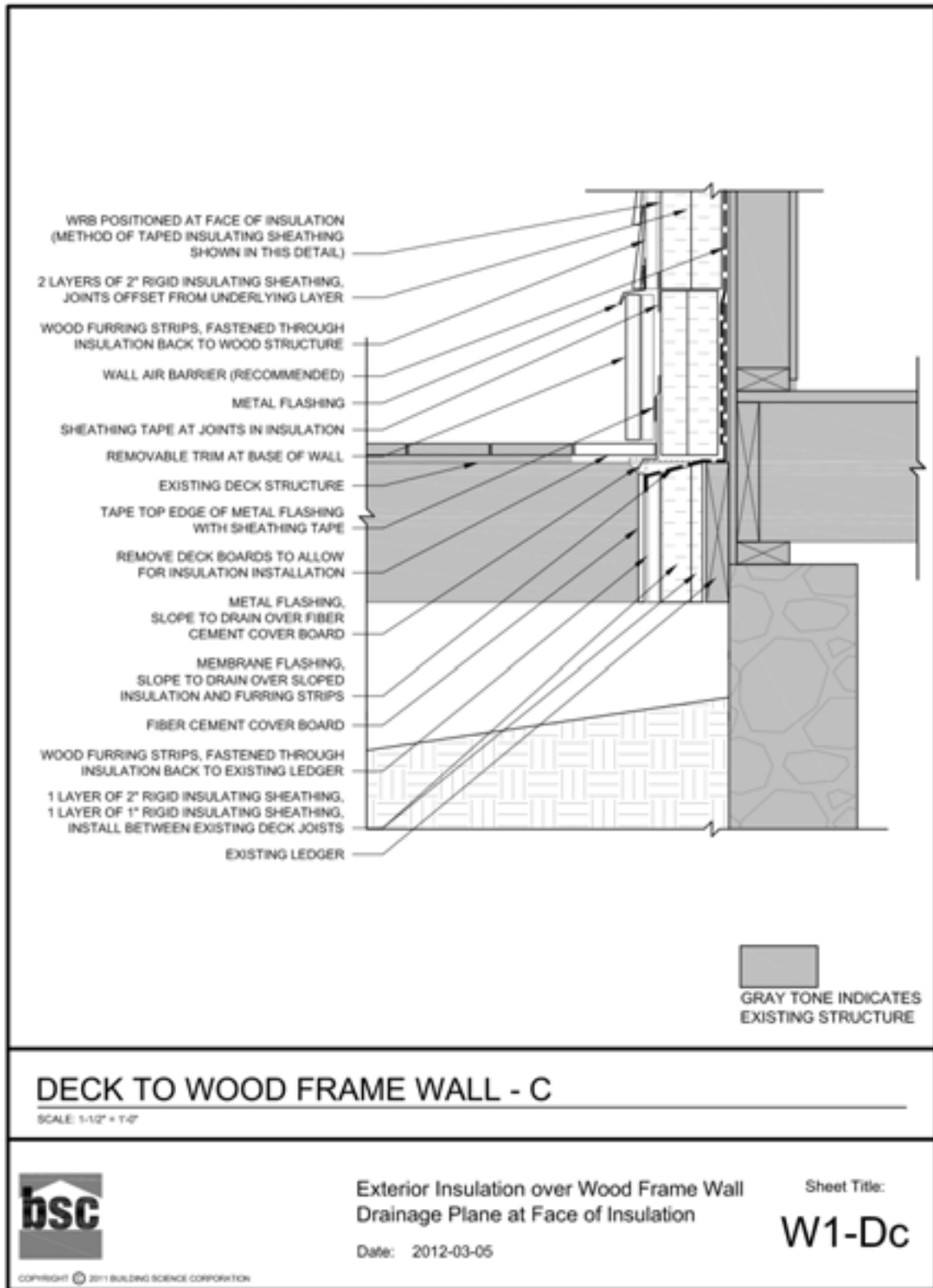

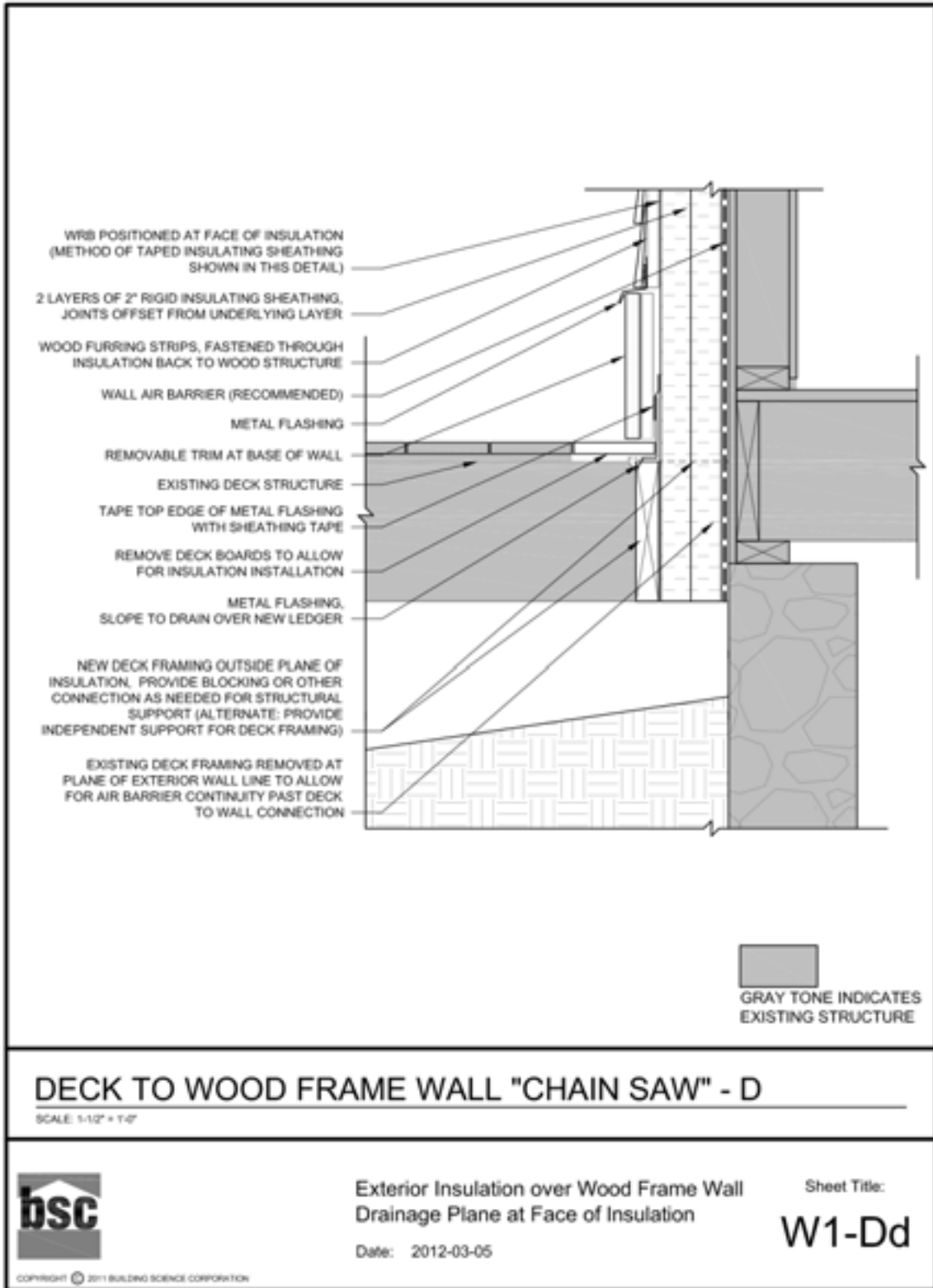

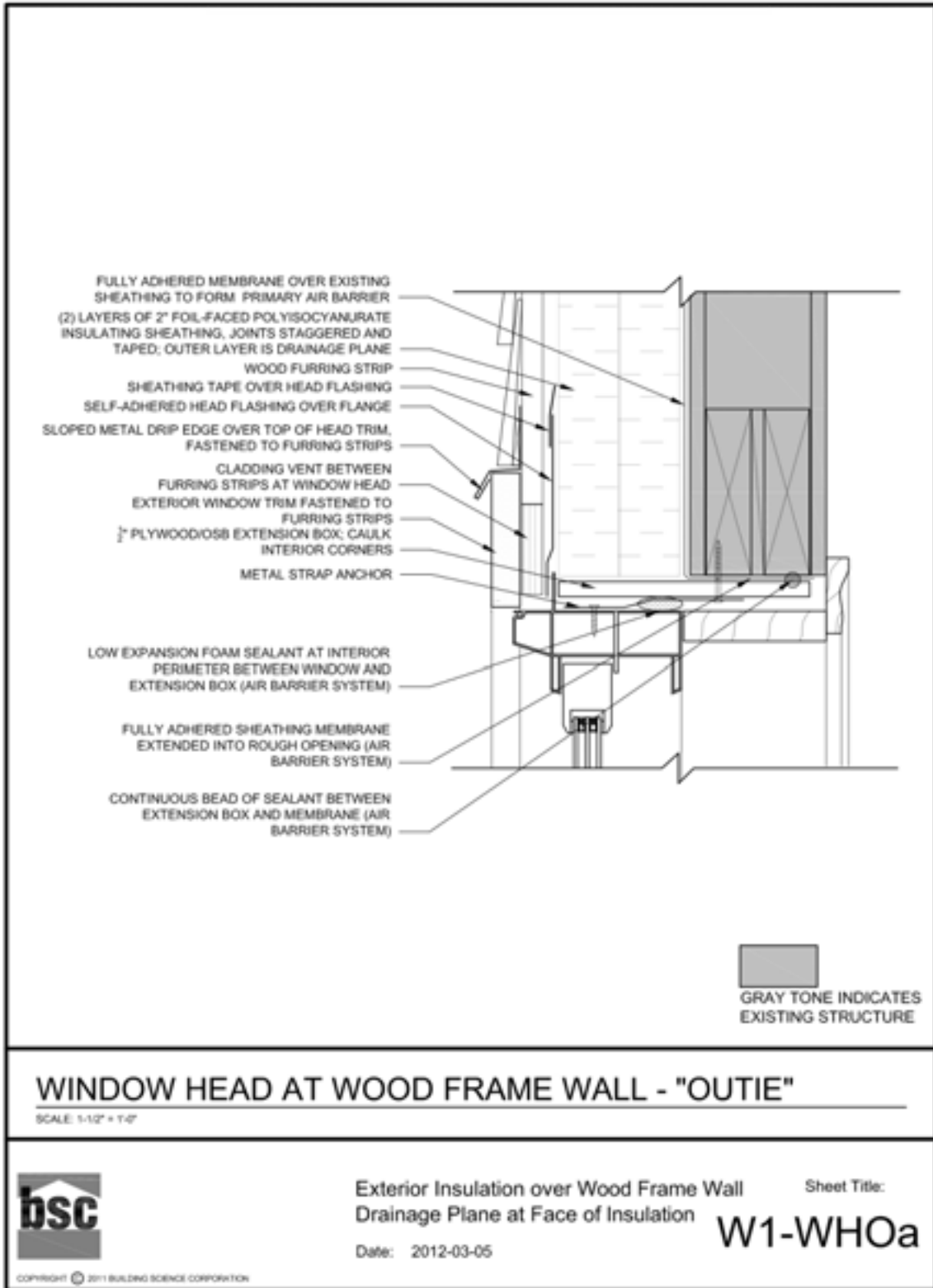

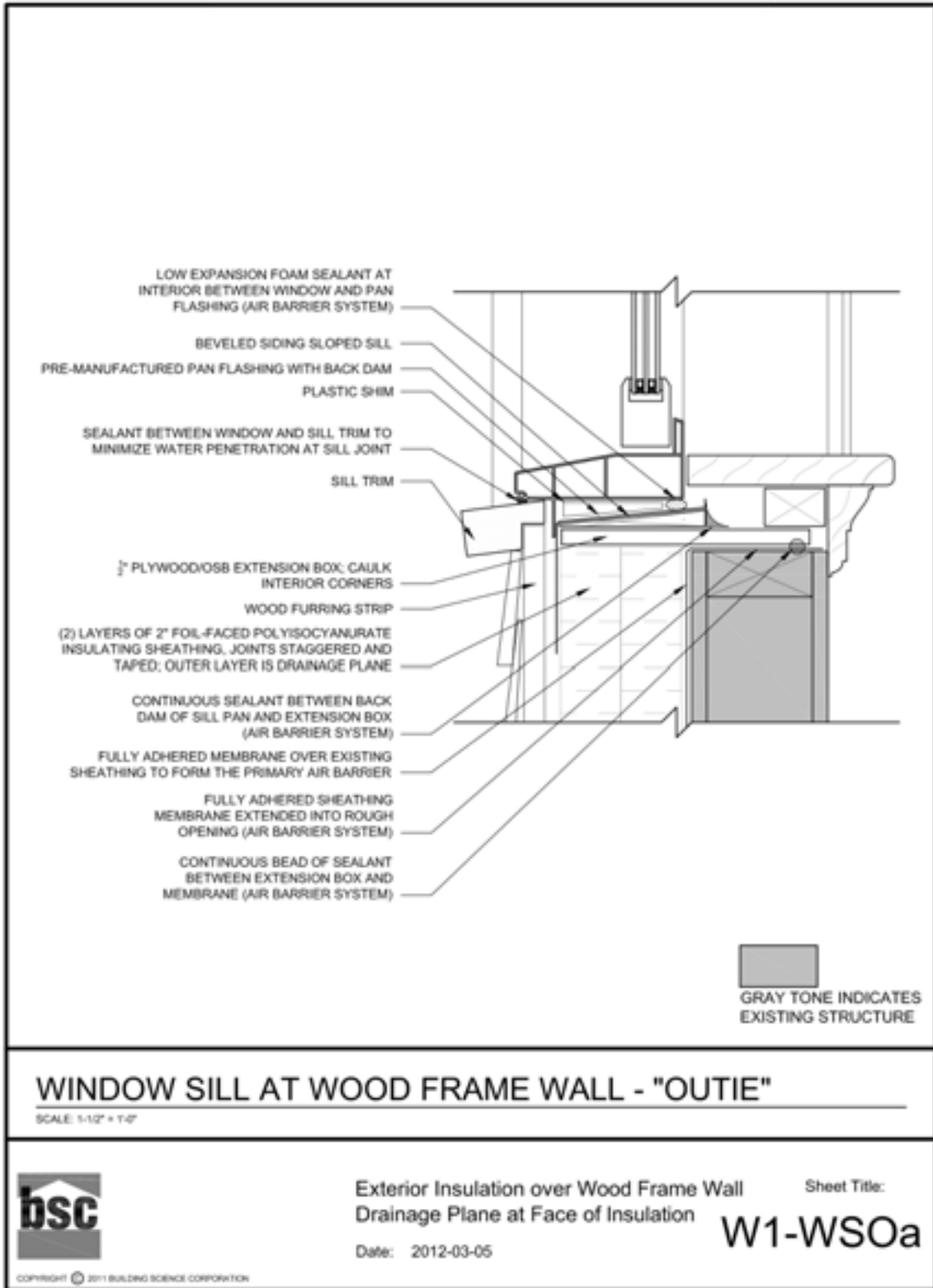

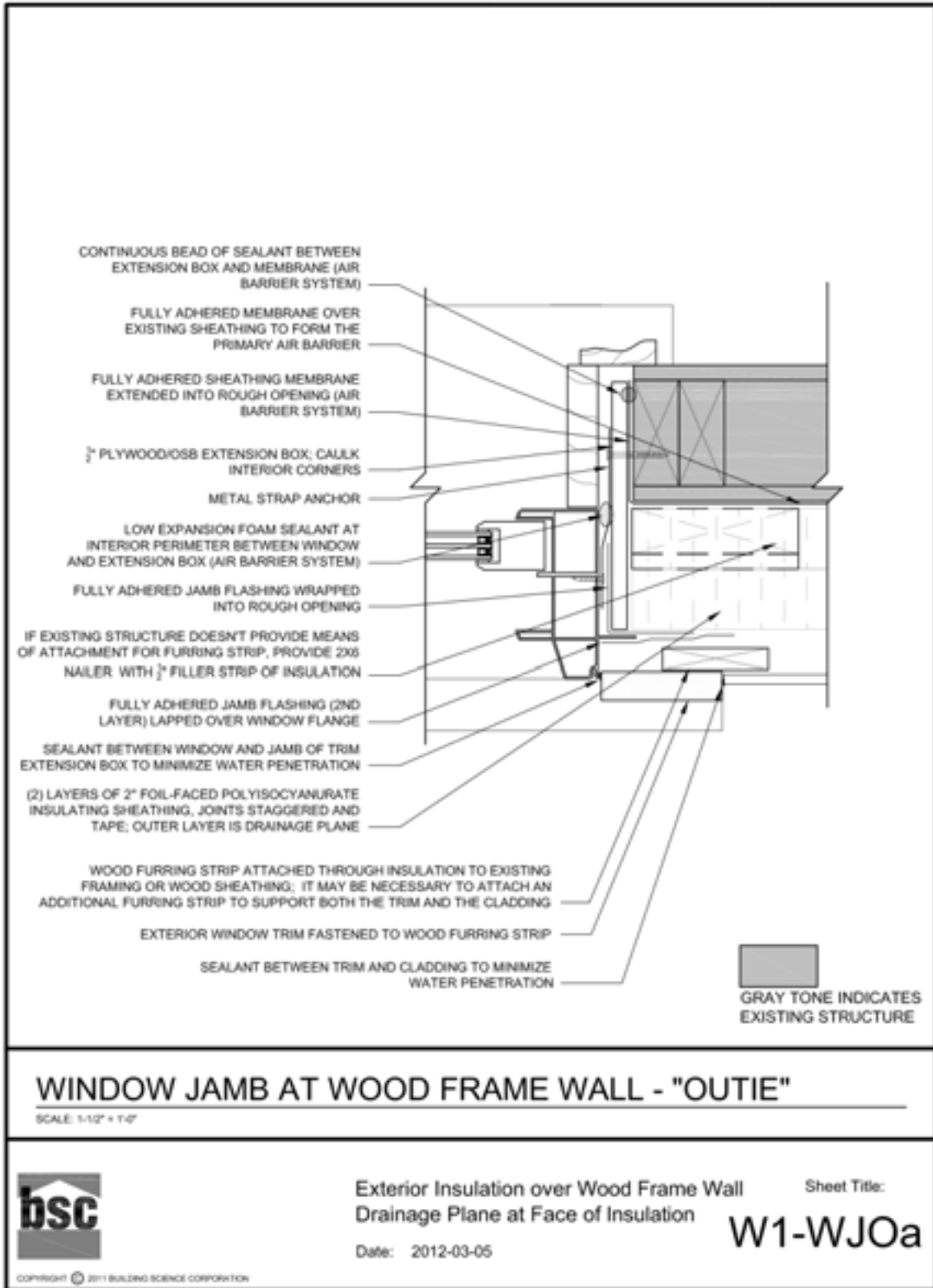

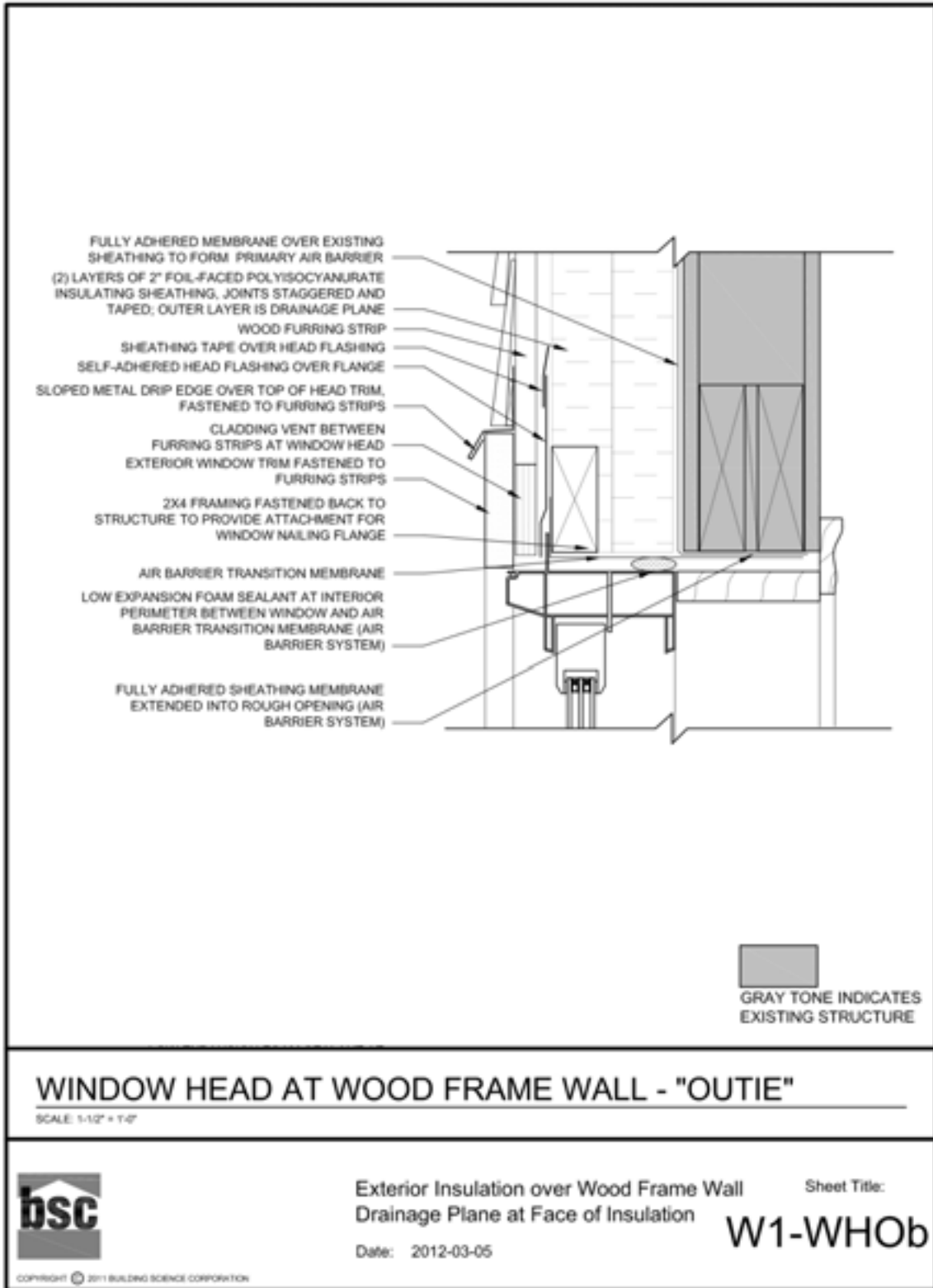

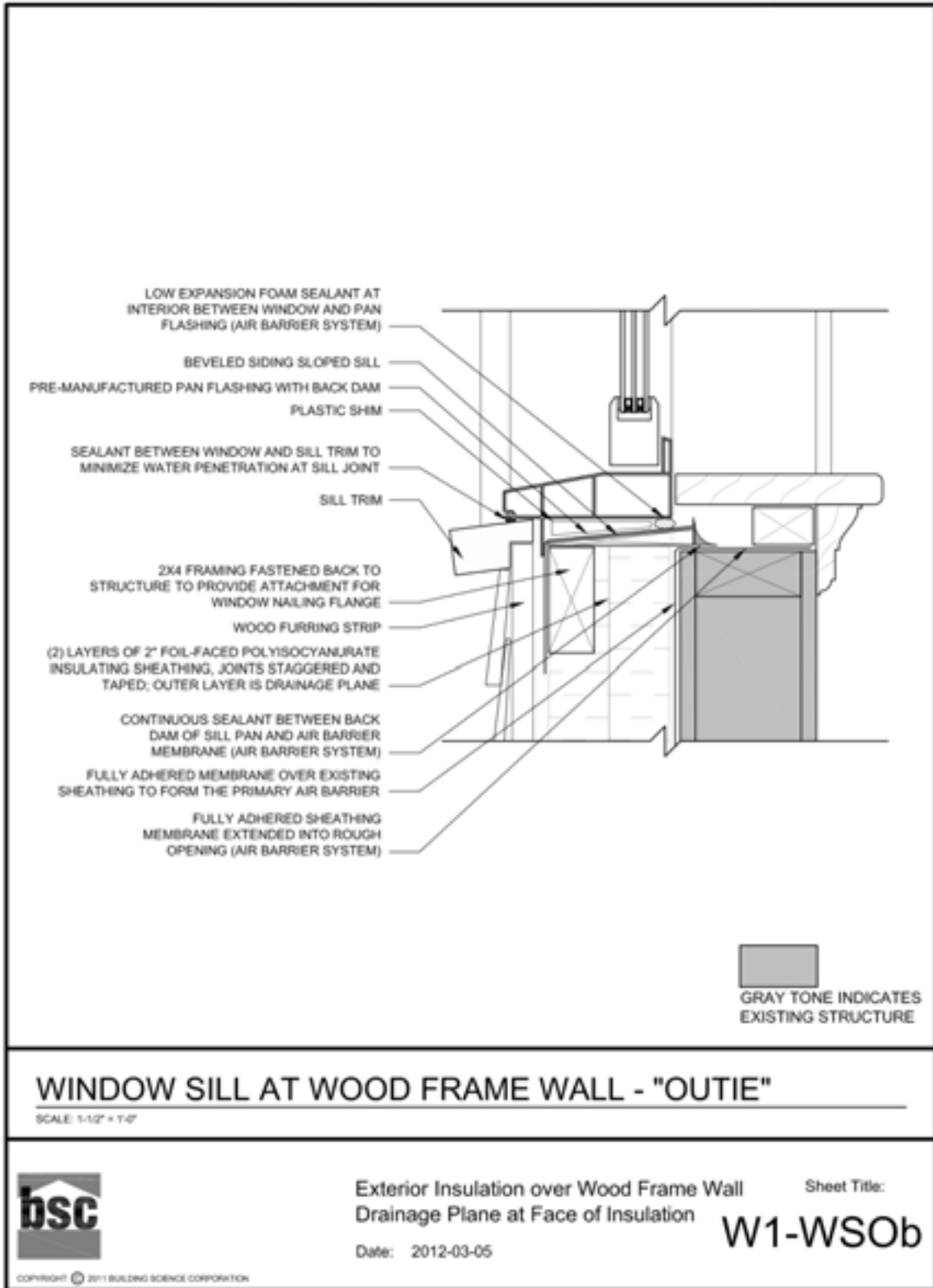

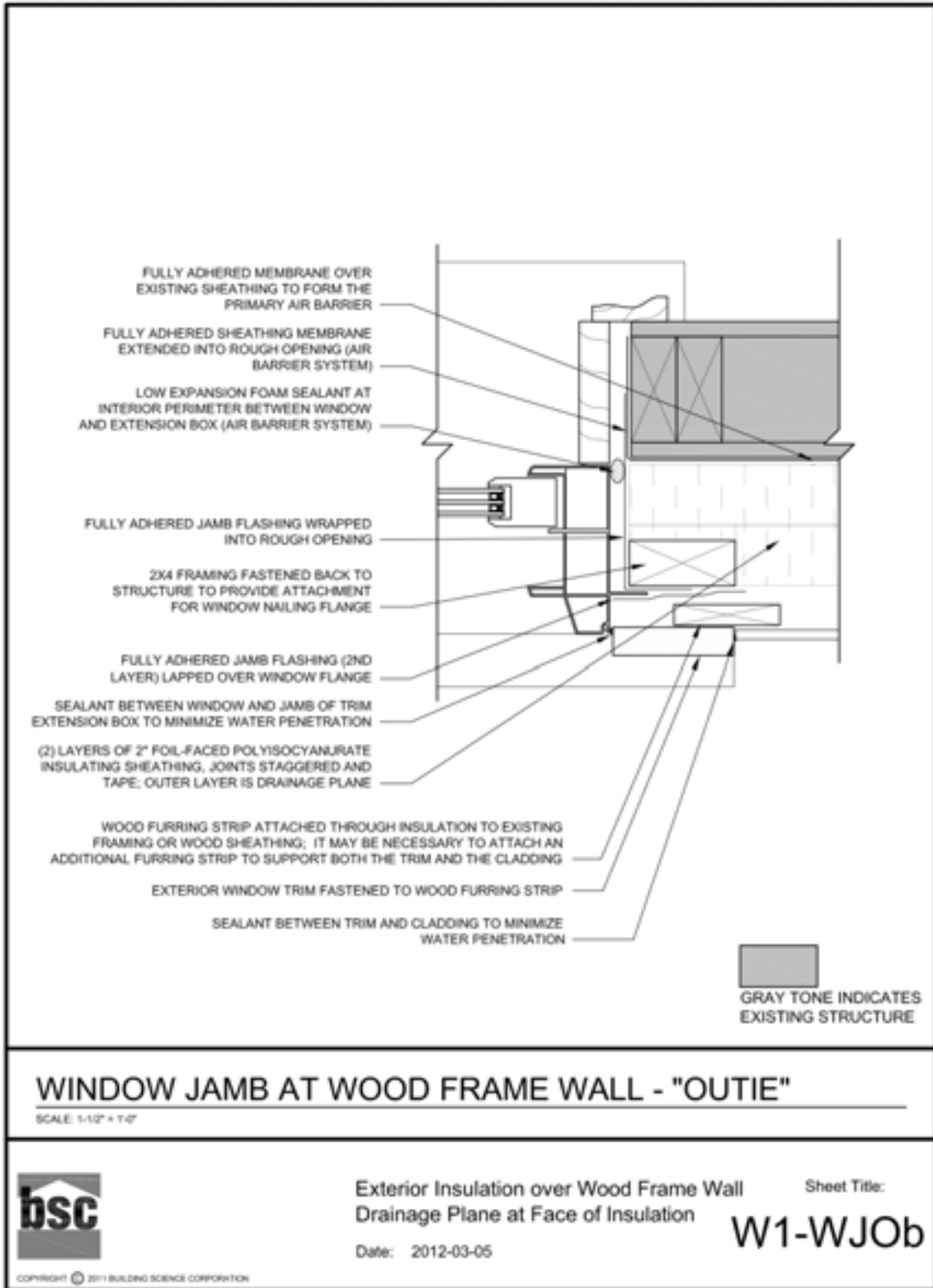

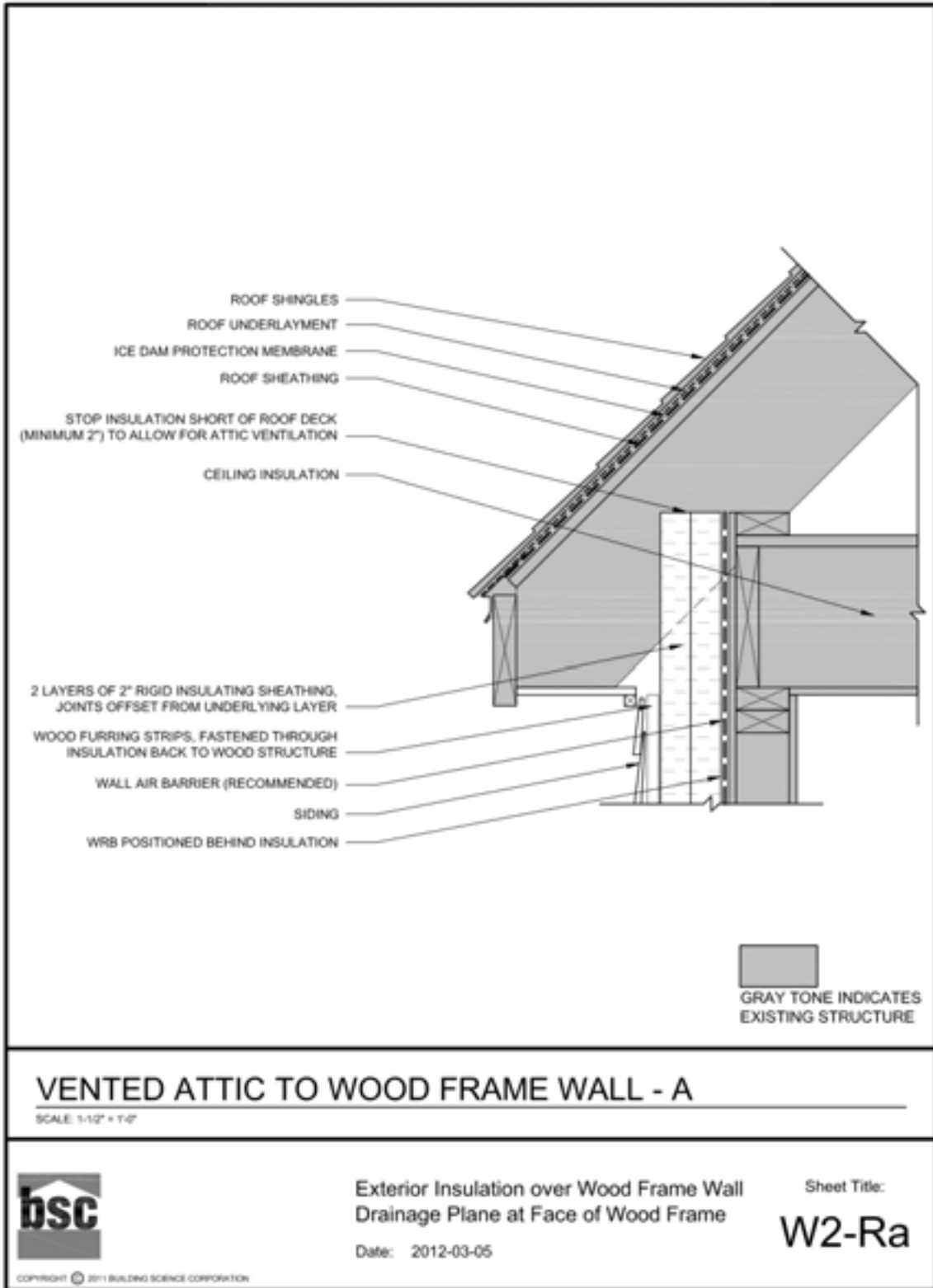

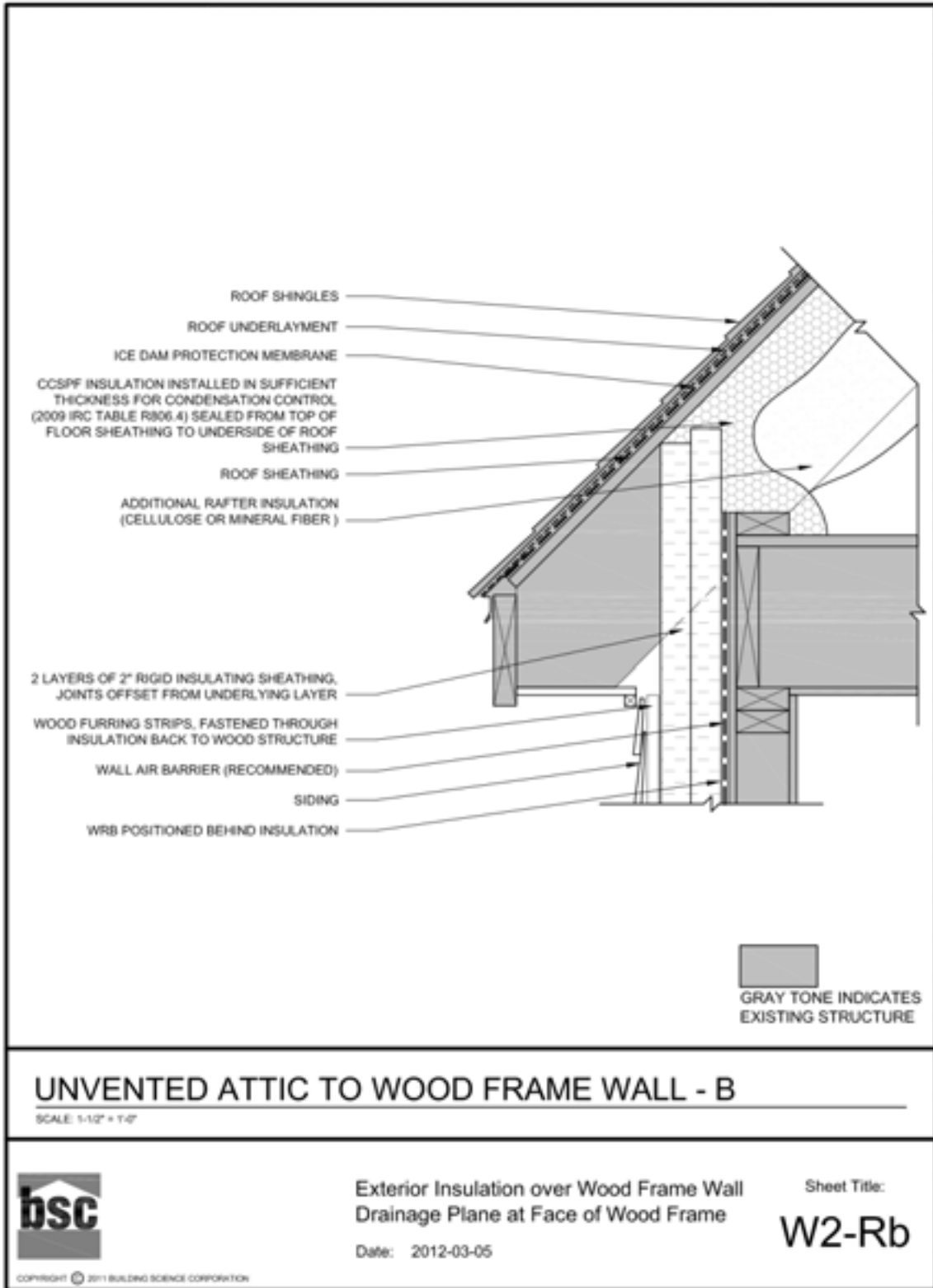

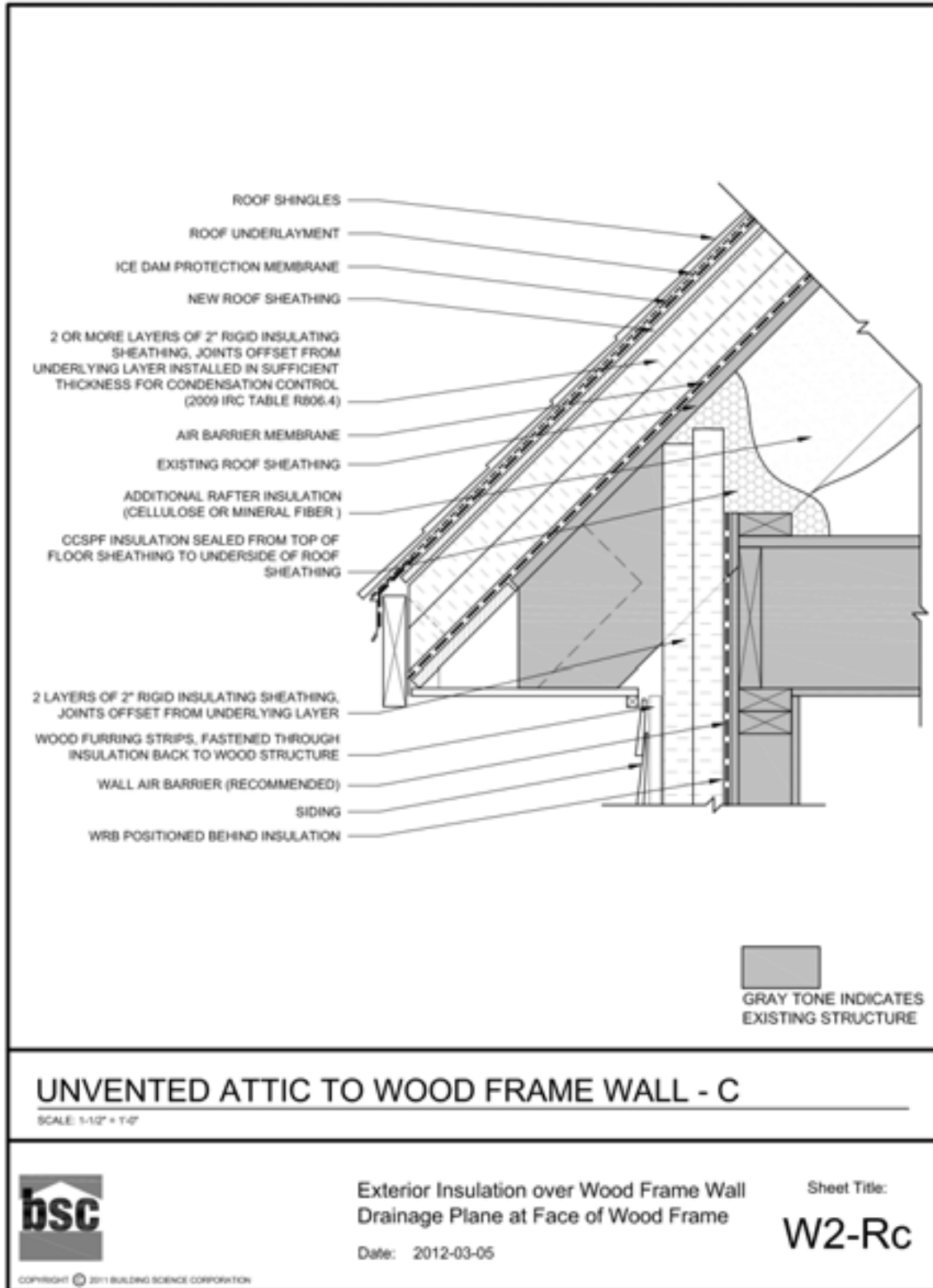

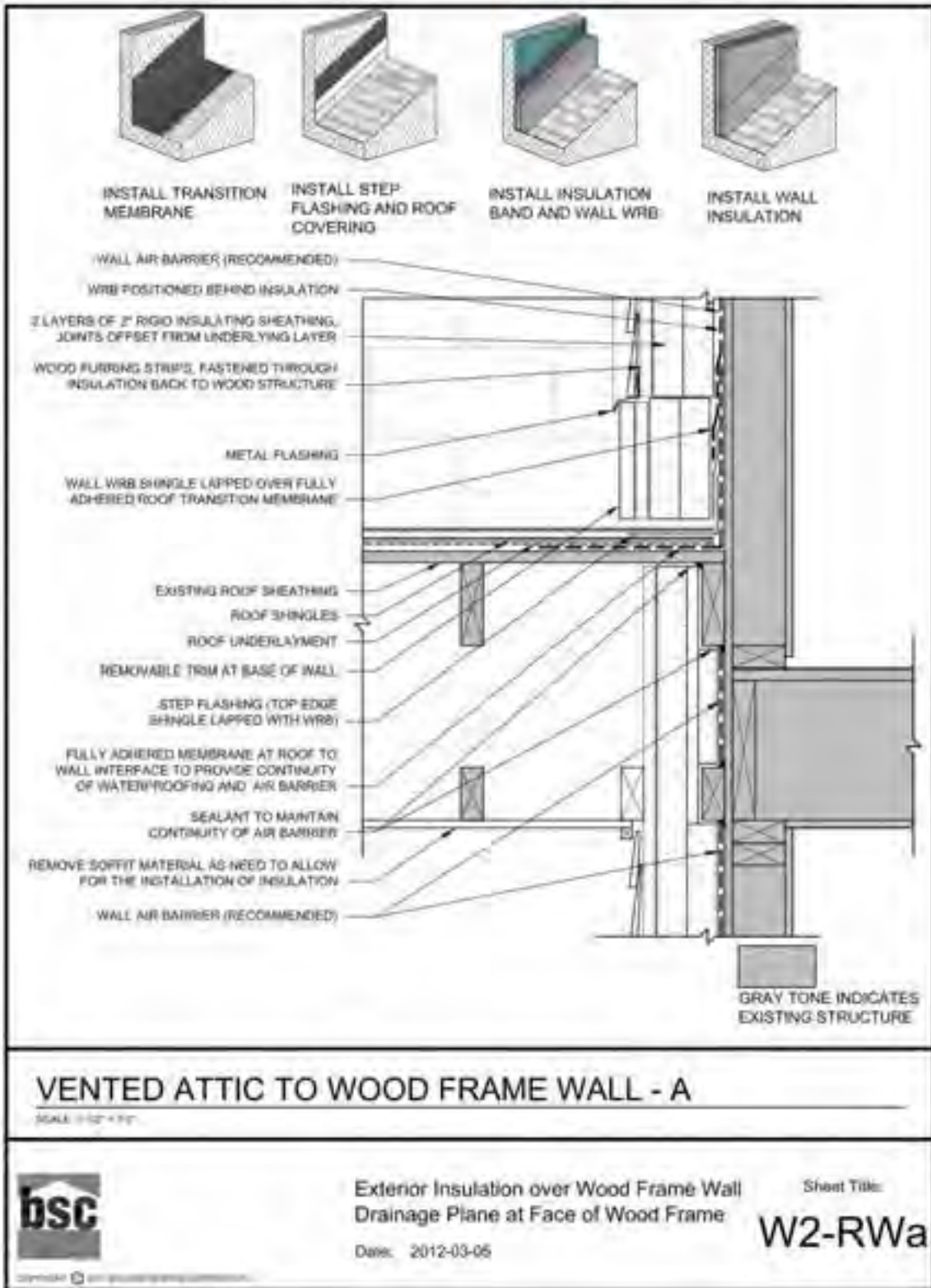

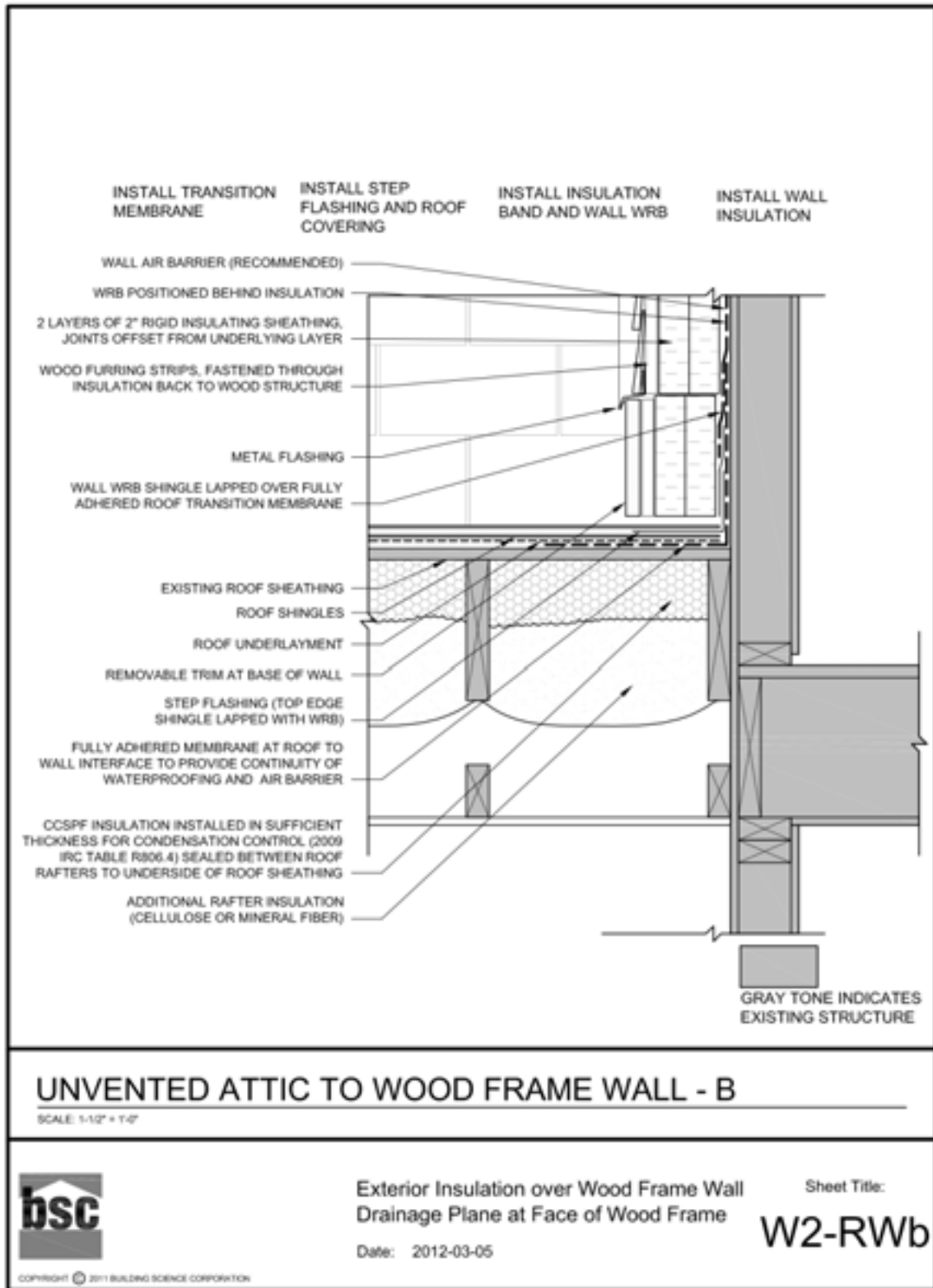

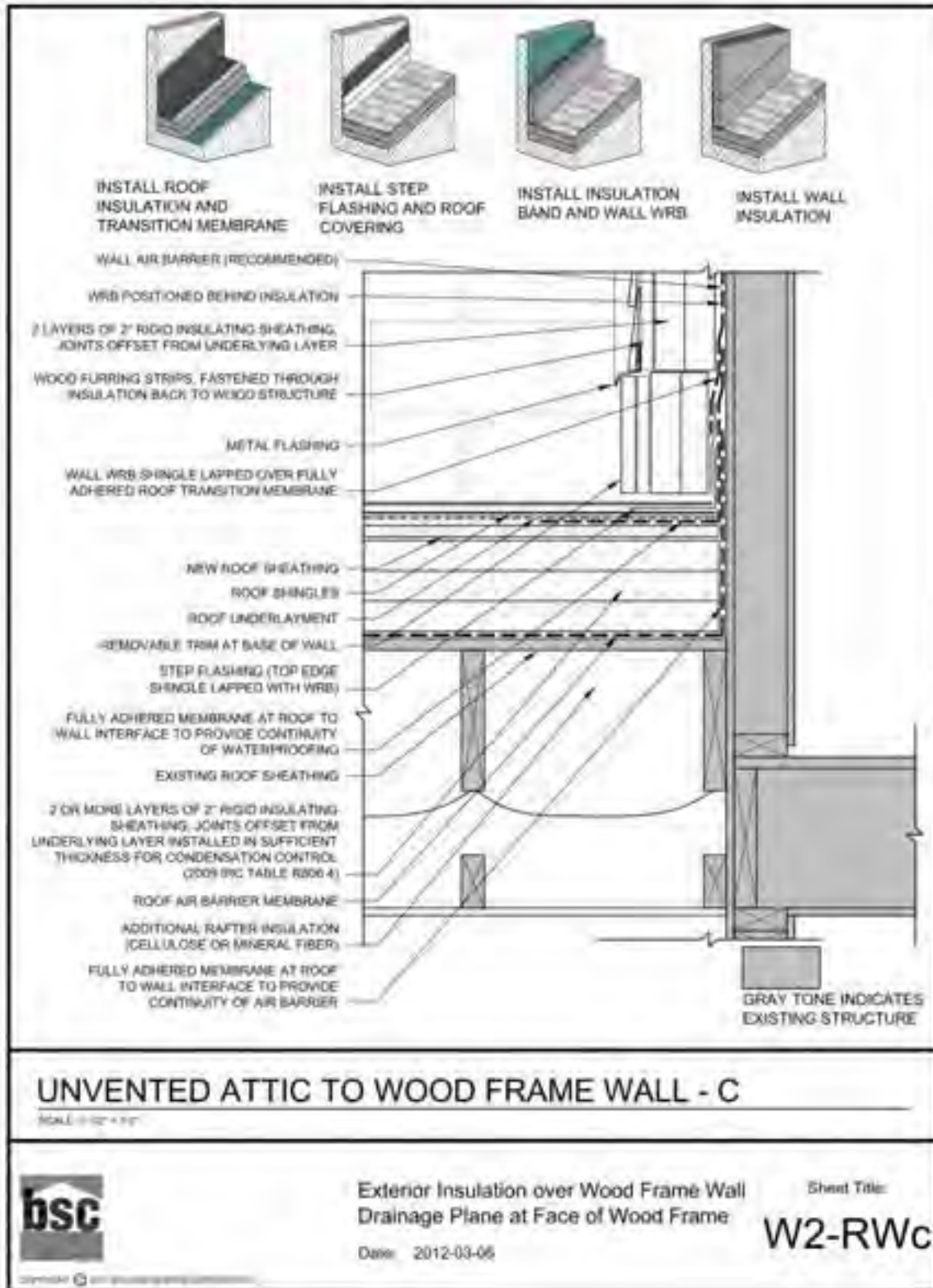

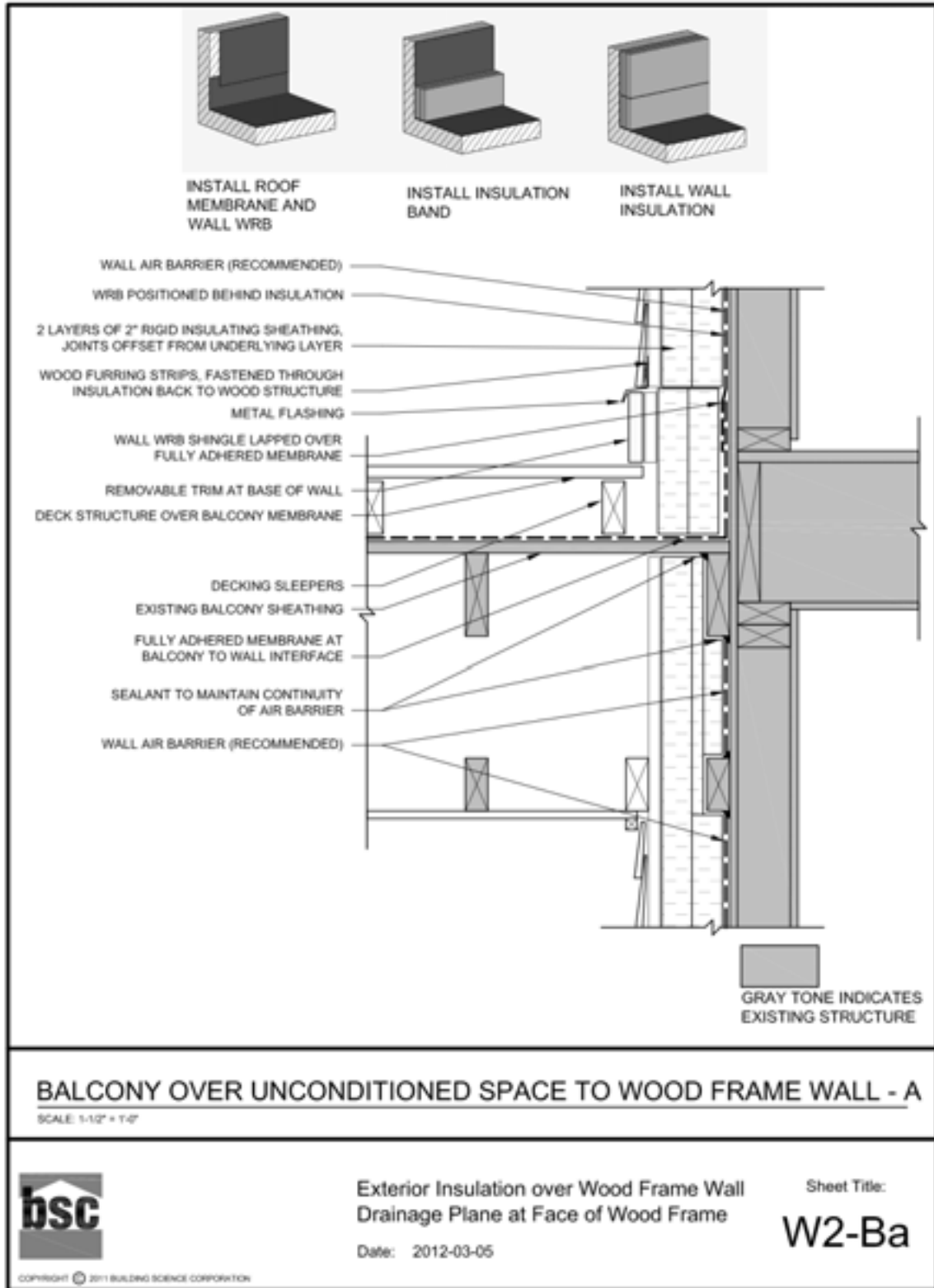

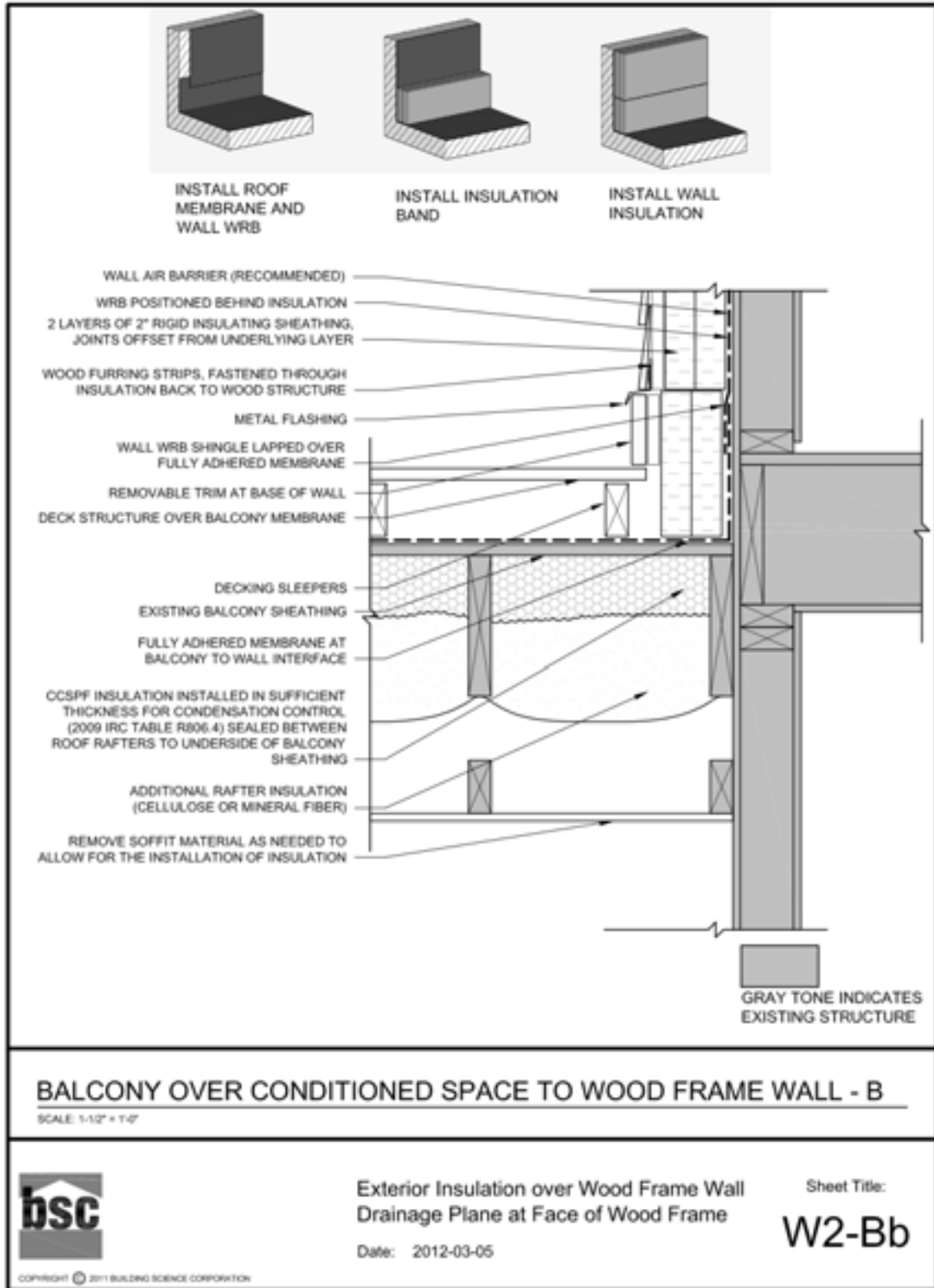

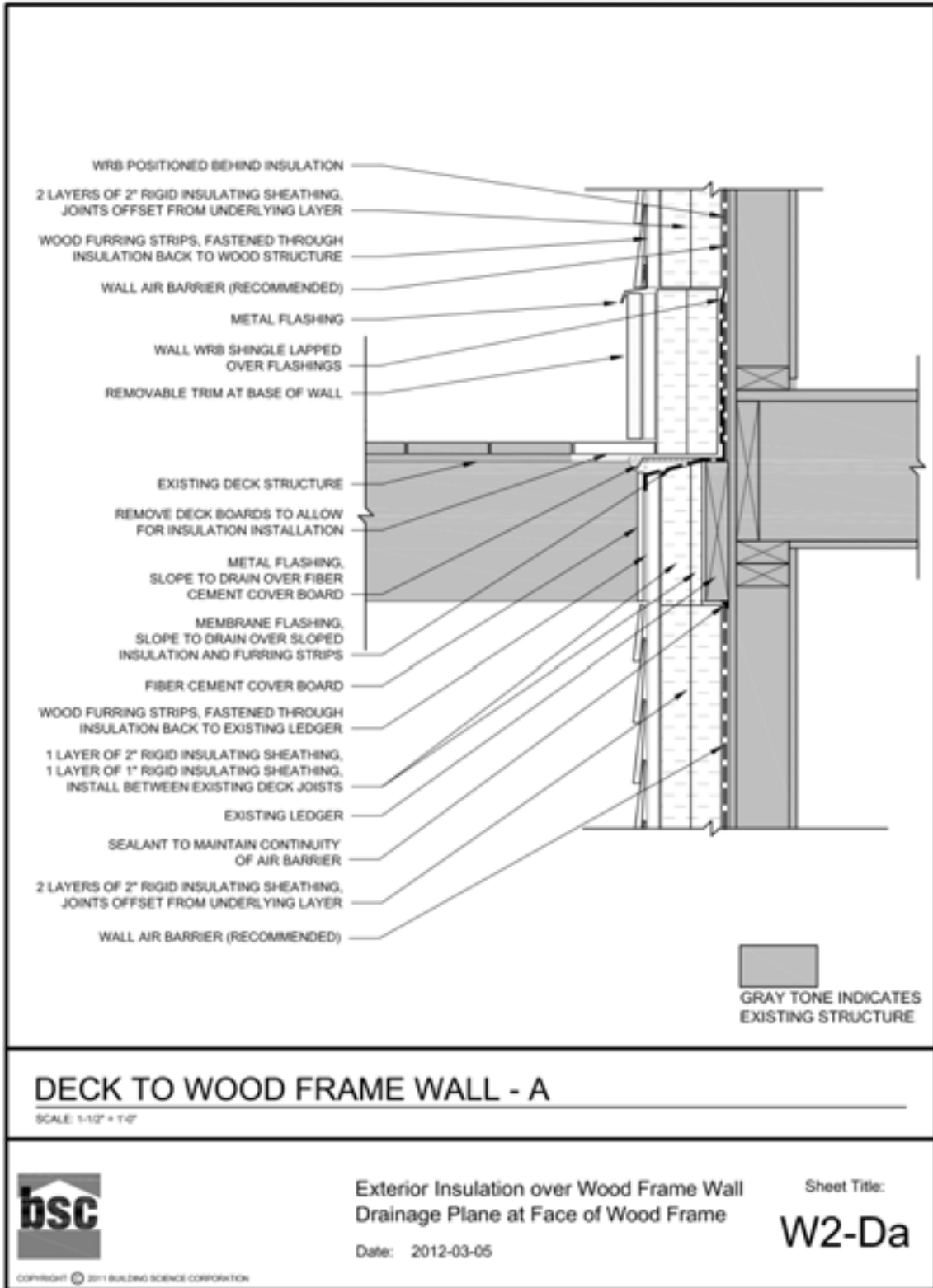

DECK TO WOOD FRAME WALL - A

SCALE: 1-1/2" = 1'-0"



COPYRIGHT © 2011 BUILDING SCIENCE CORPORATION

Exterior Insulation over Wood Frame Wall
Drainage Plane at Face of Wood Frame

Date: 2012-03-05

Sheet Title:

W2-Da

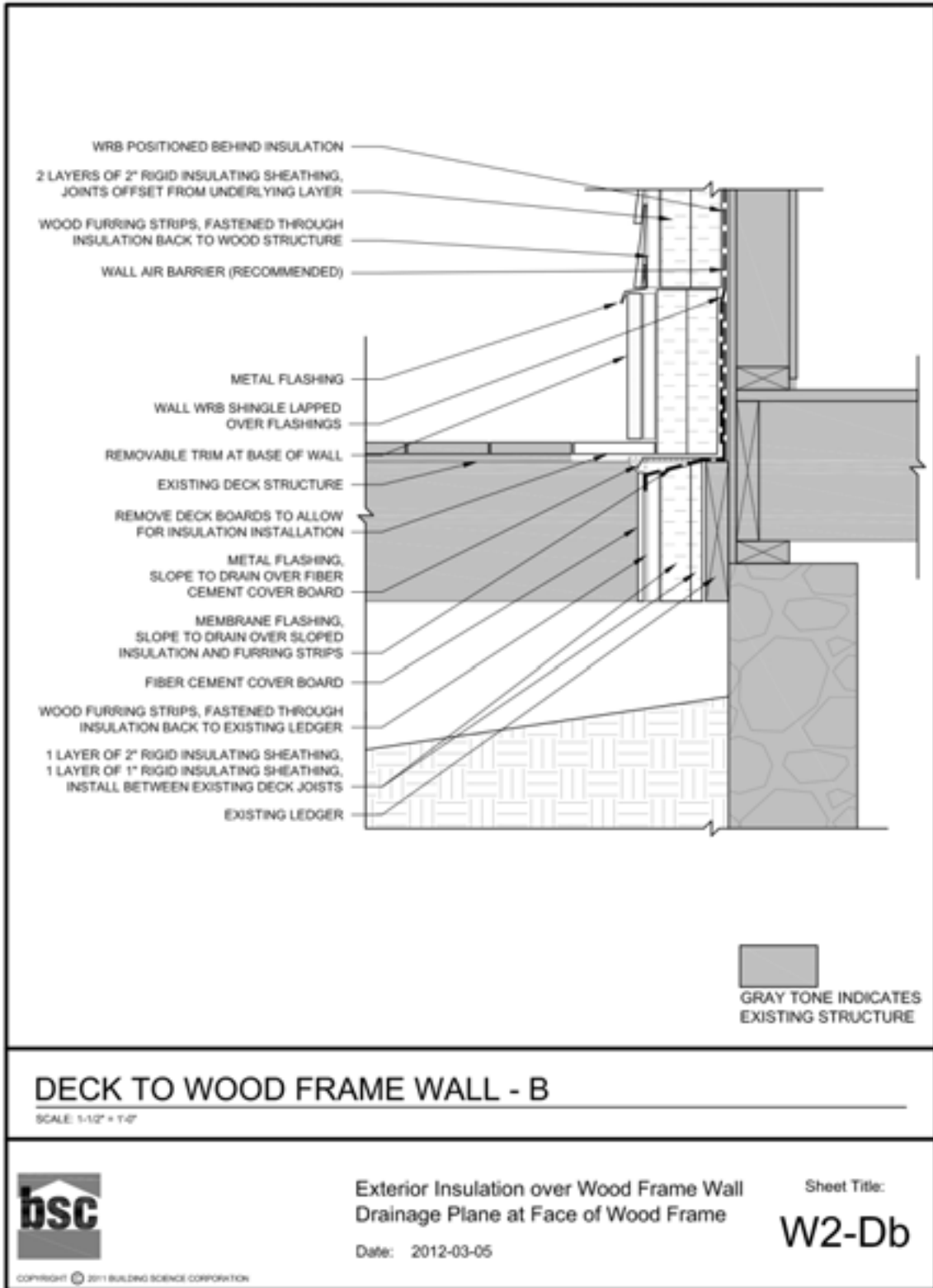

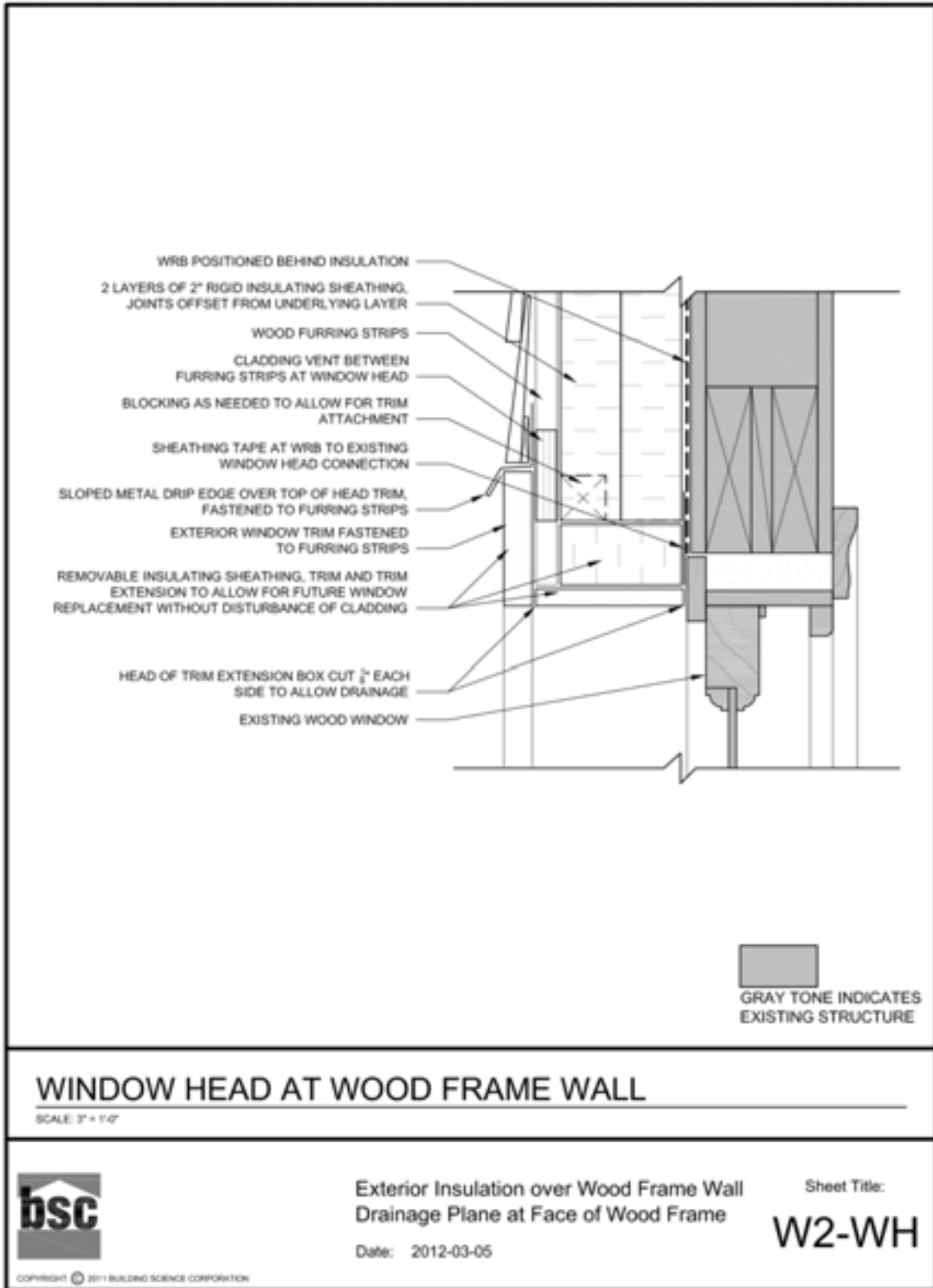

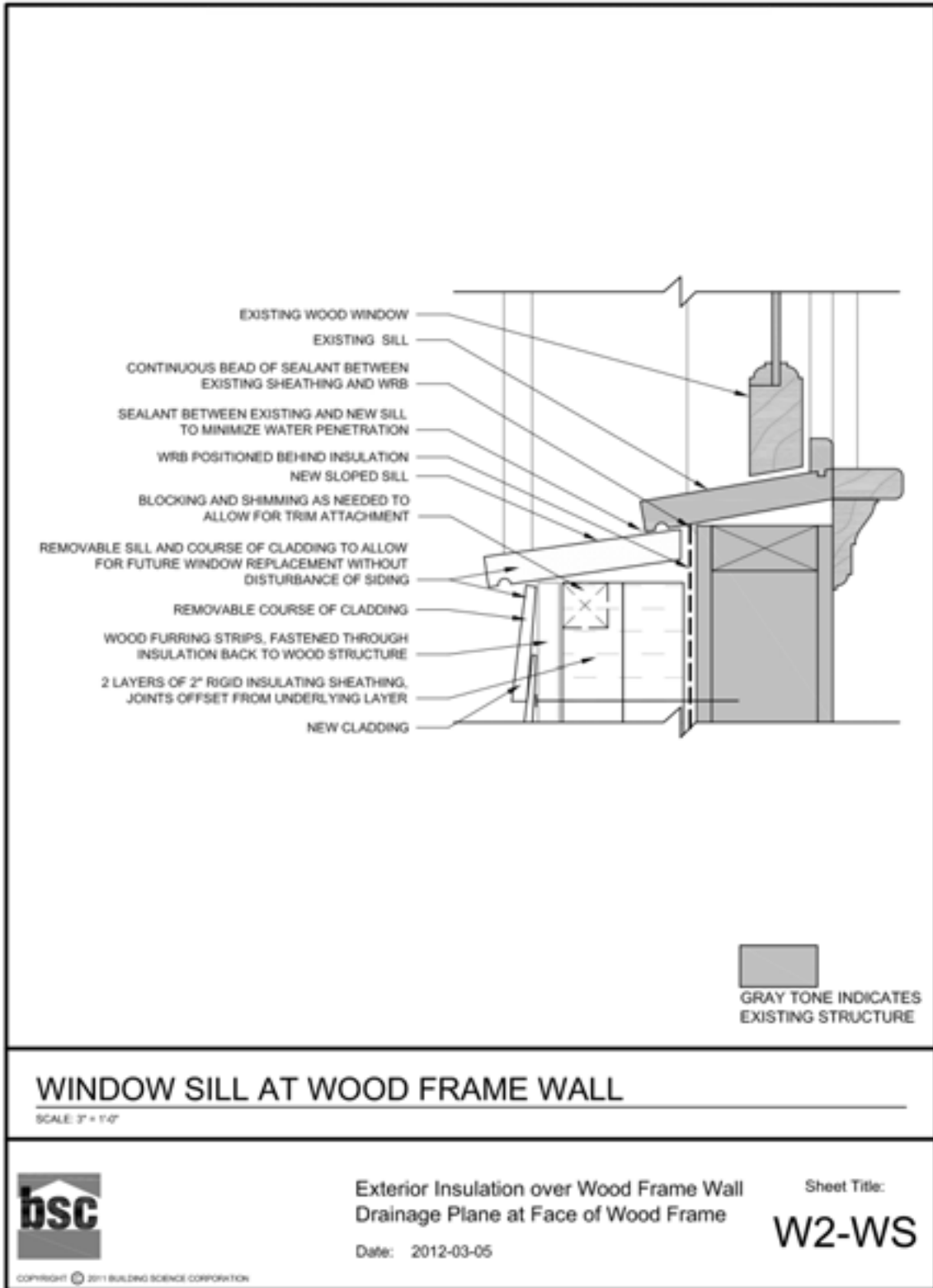

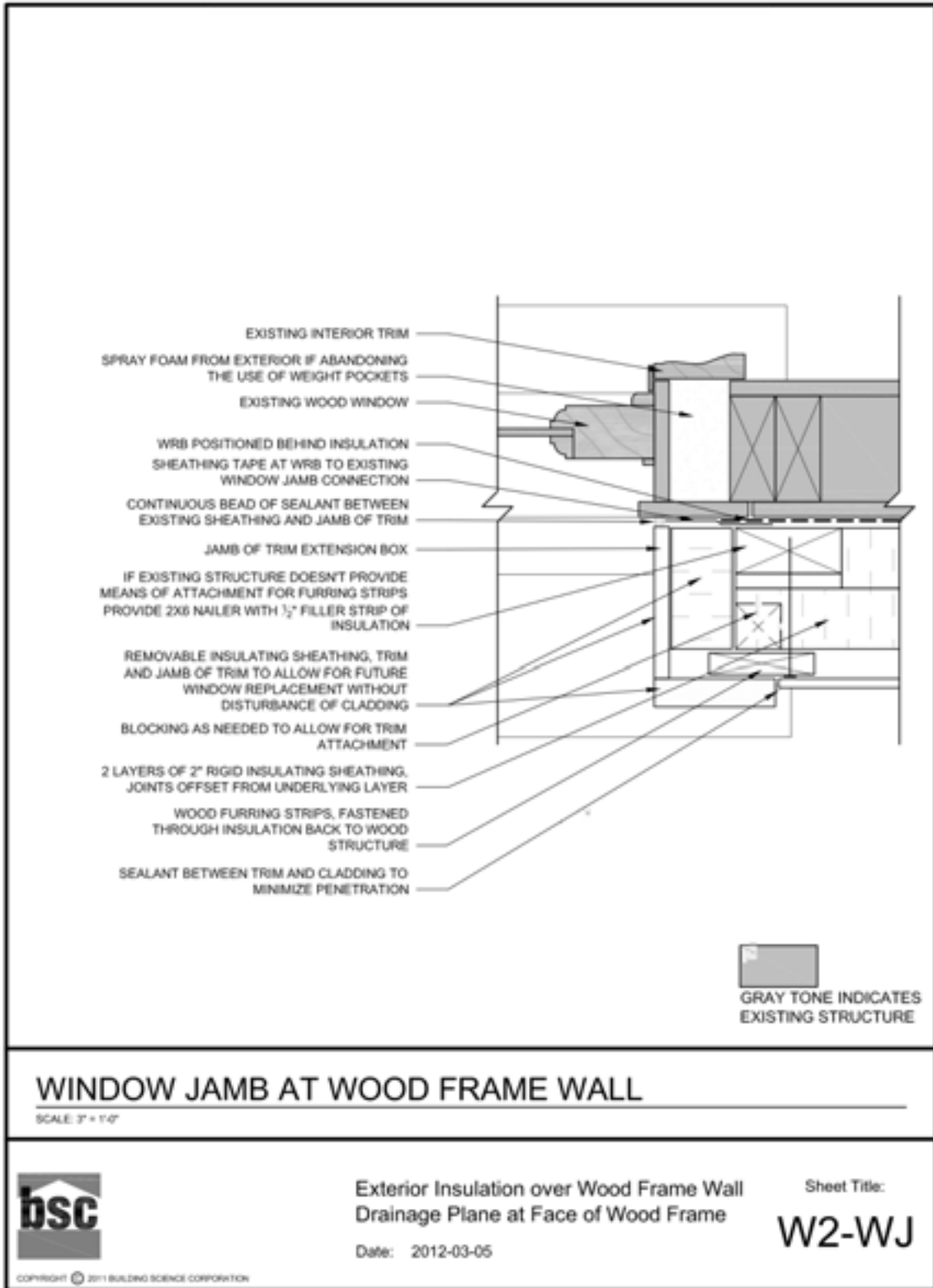

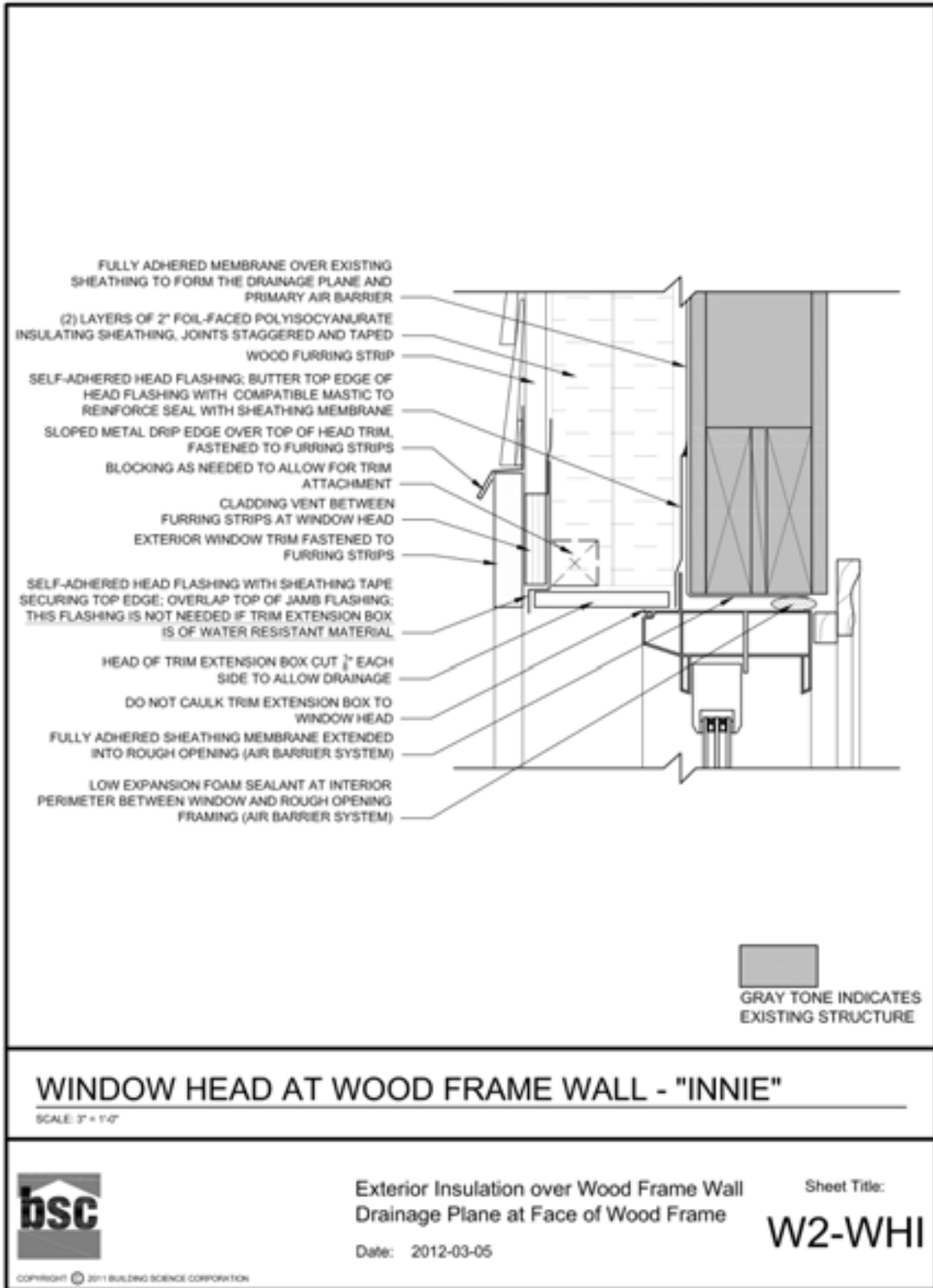

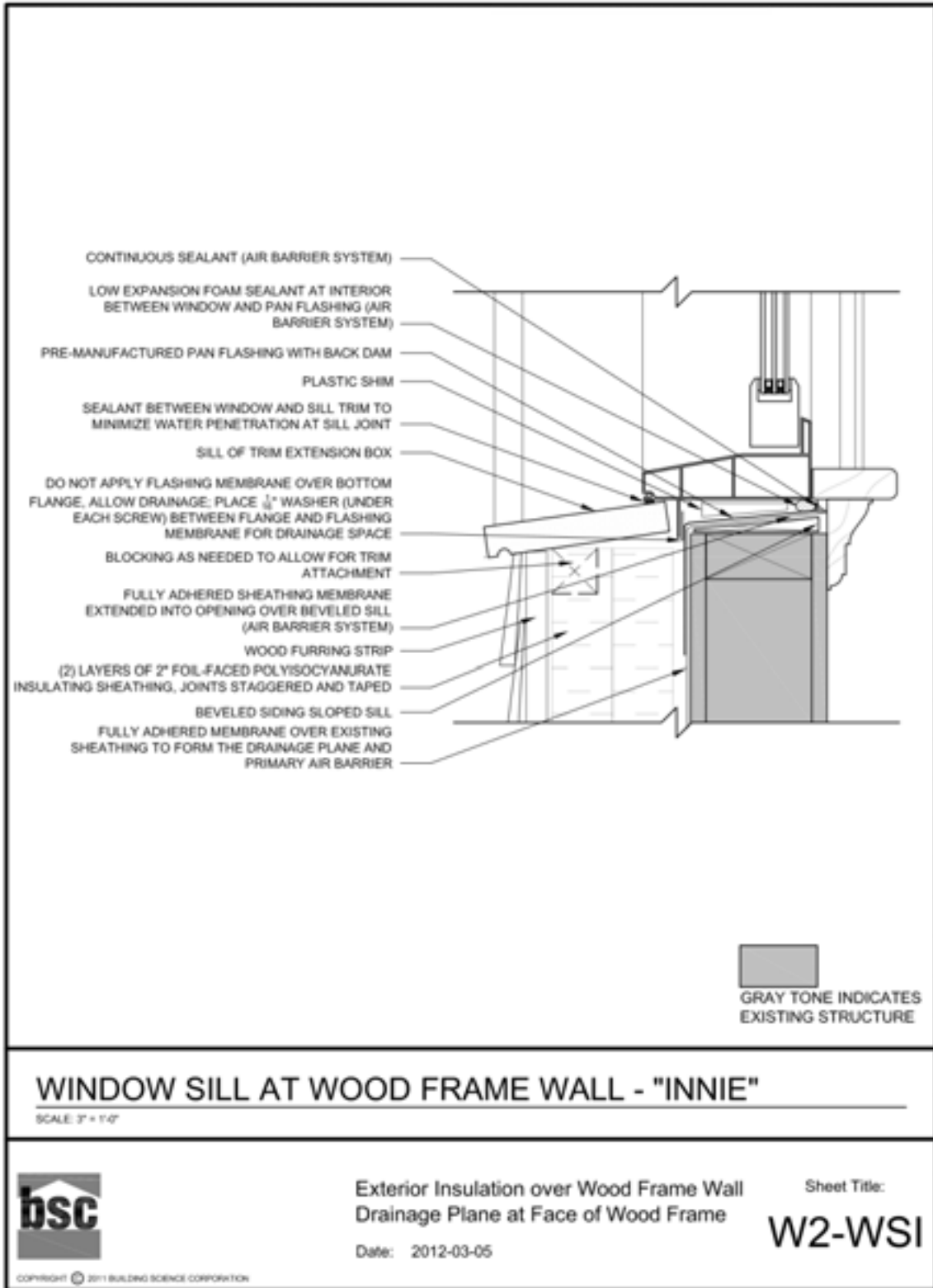

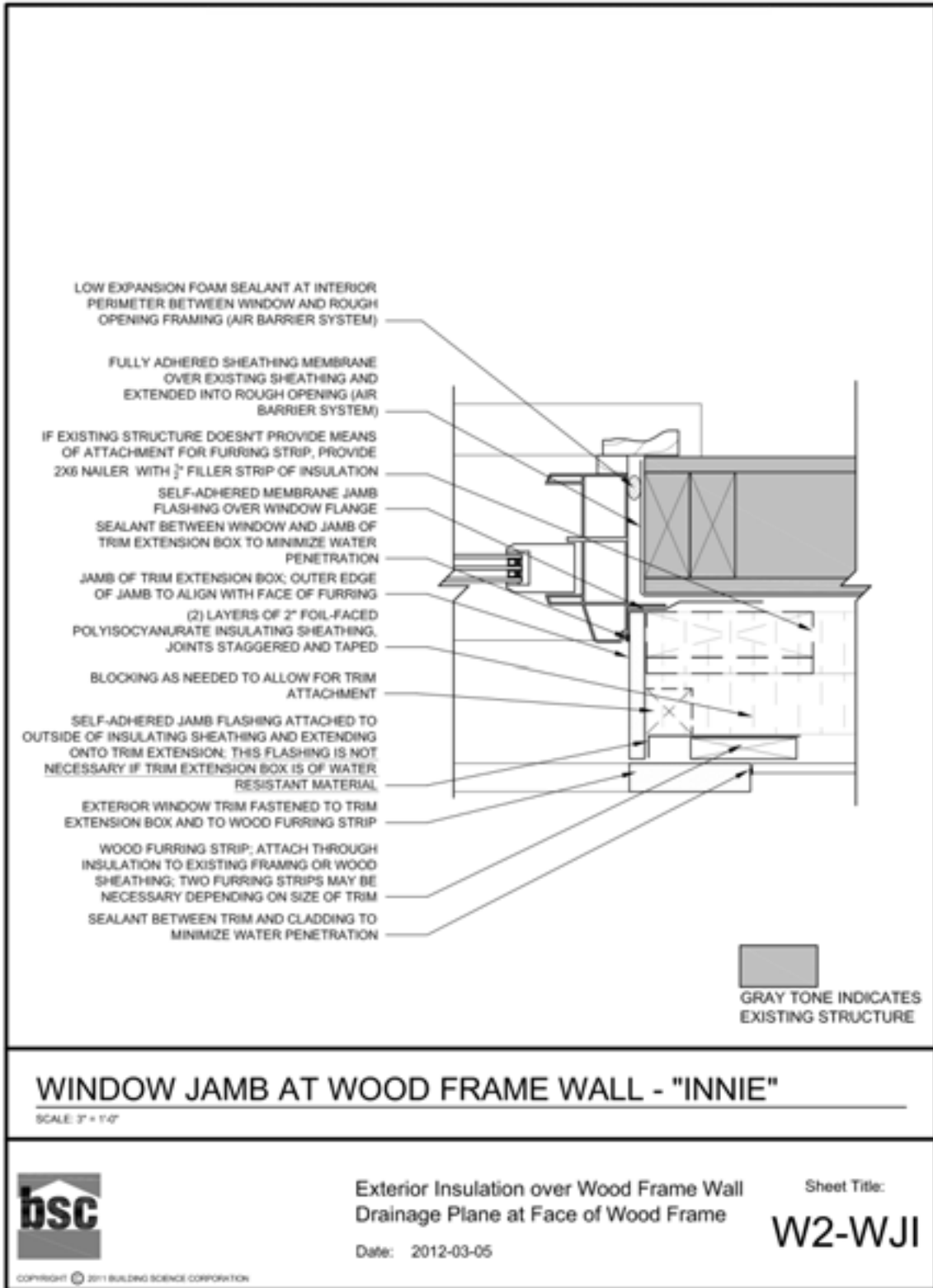

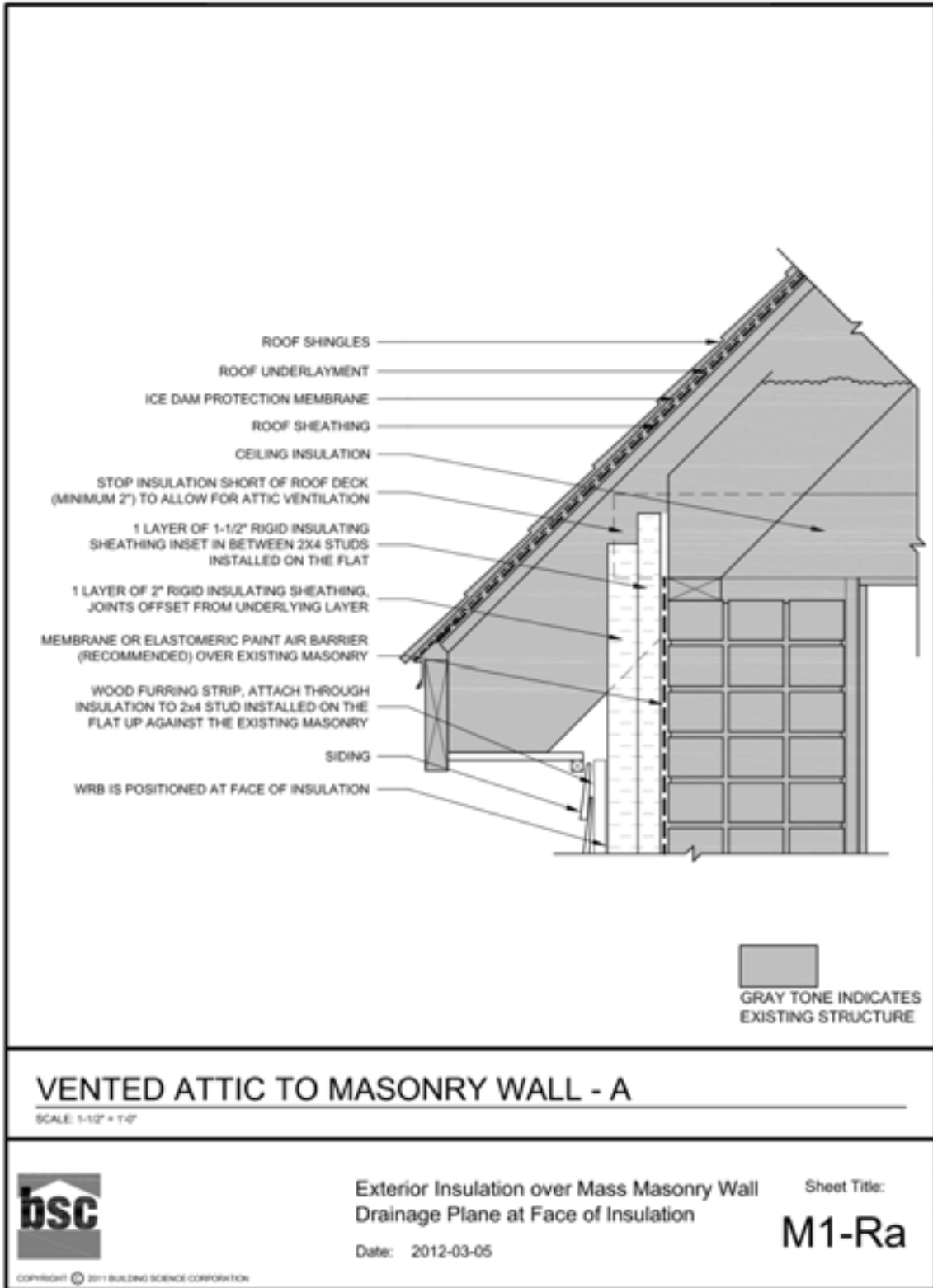

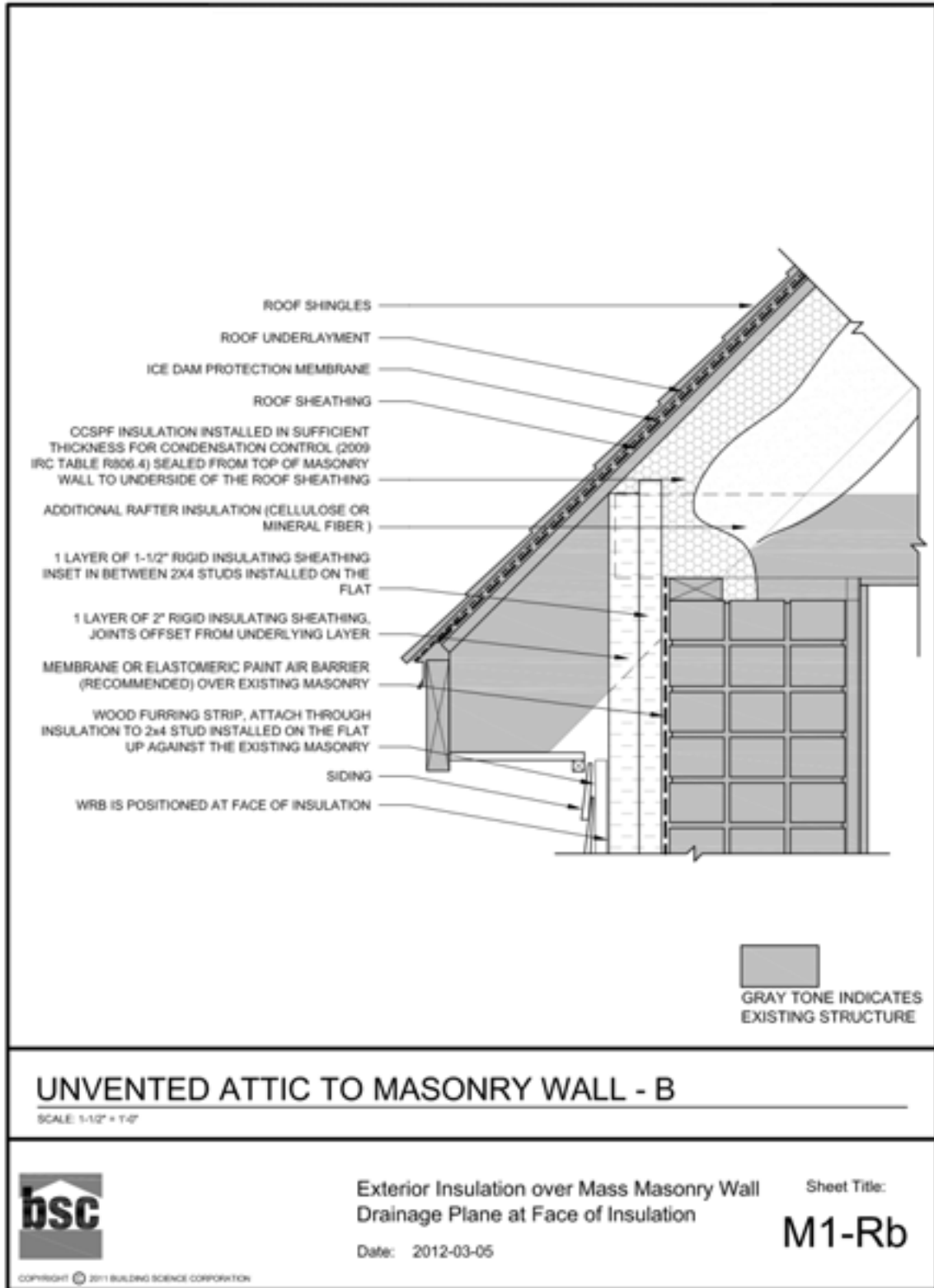

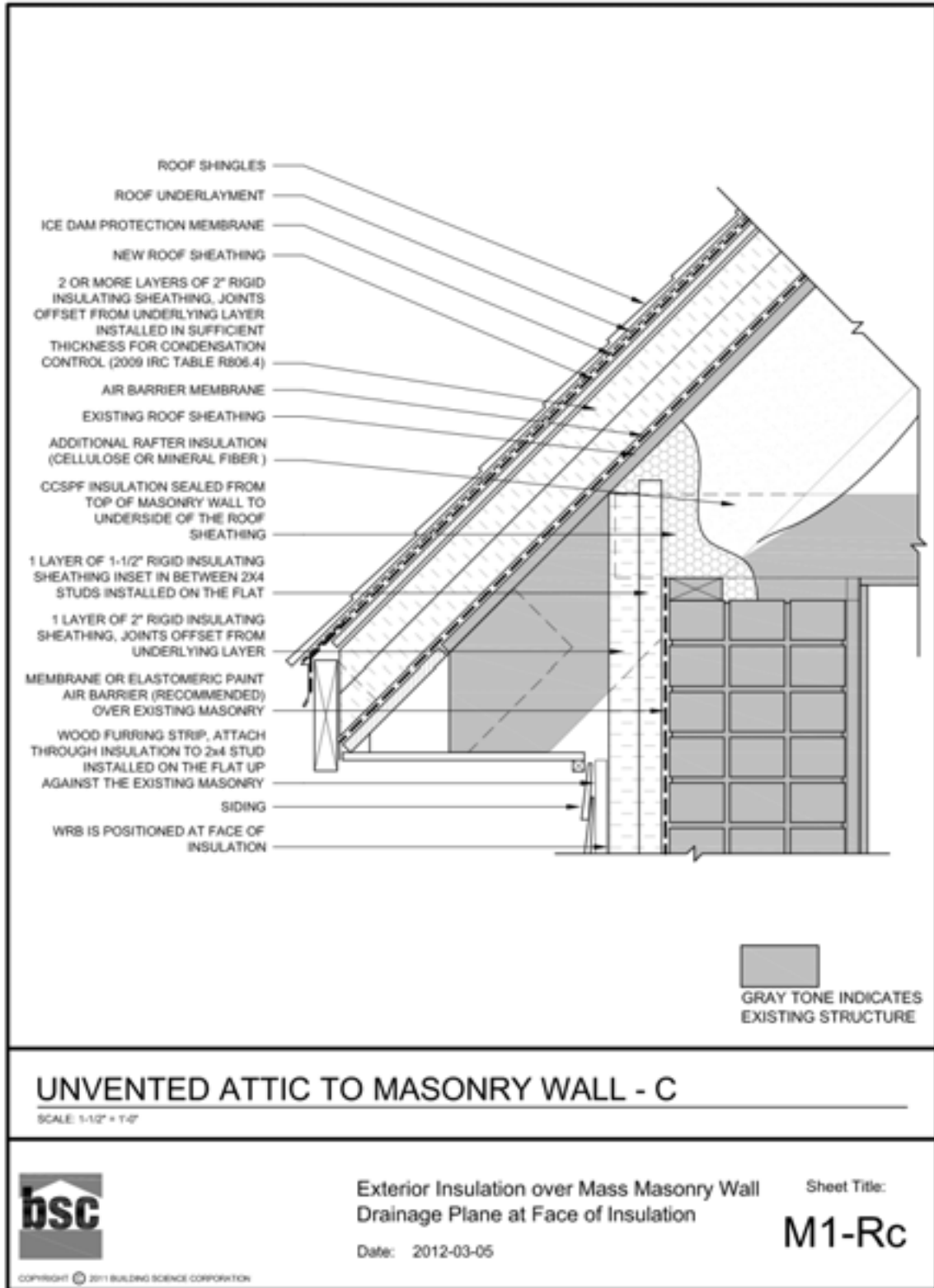

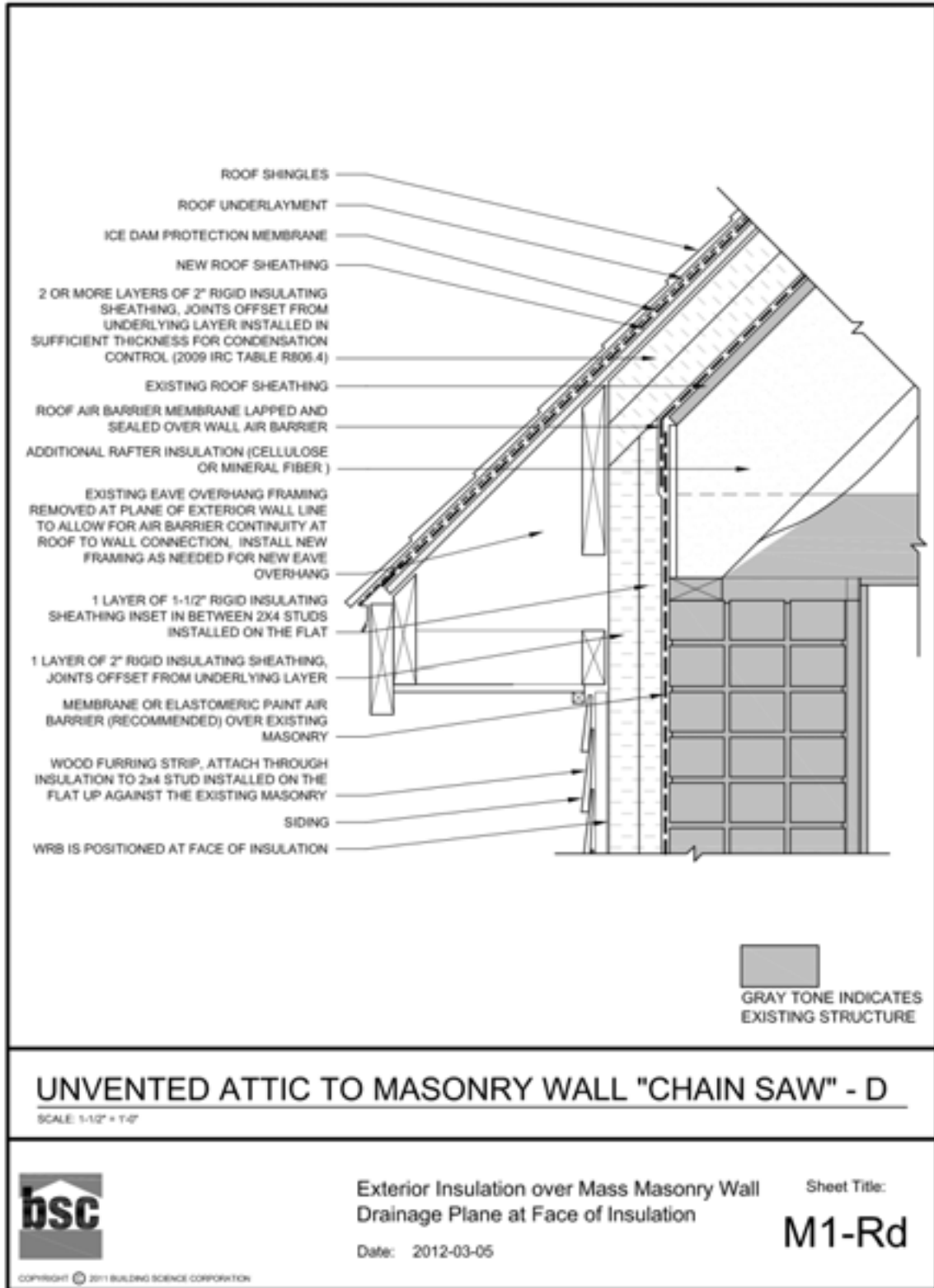

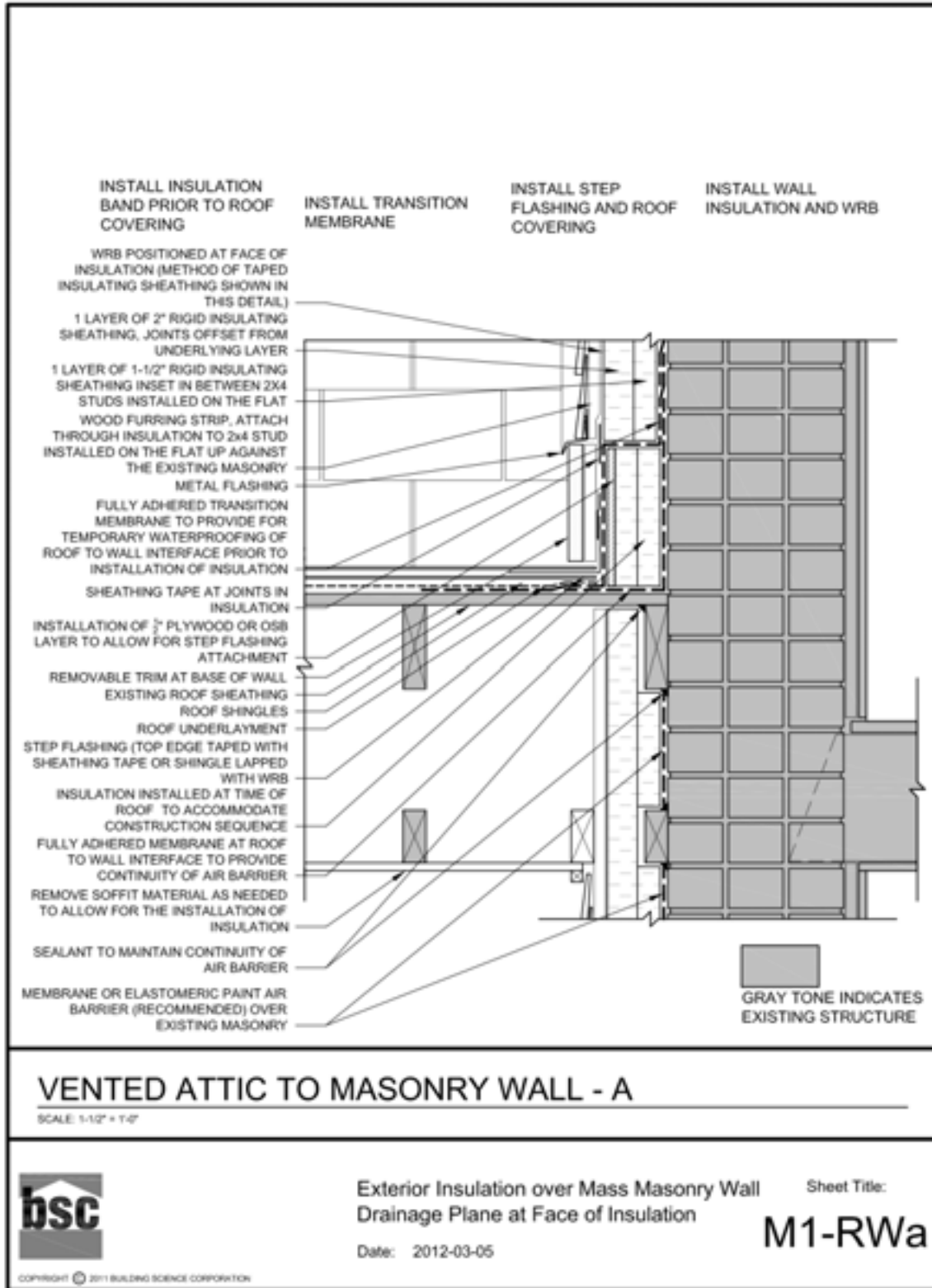

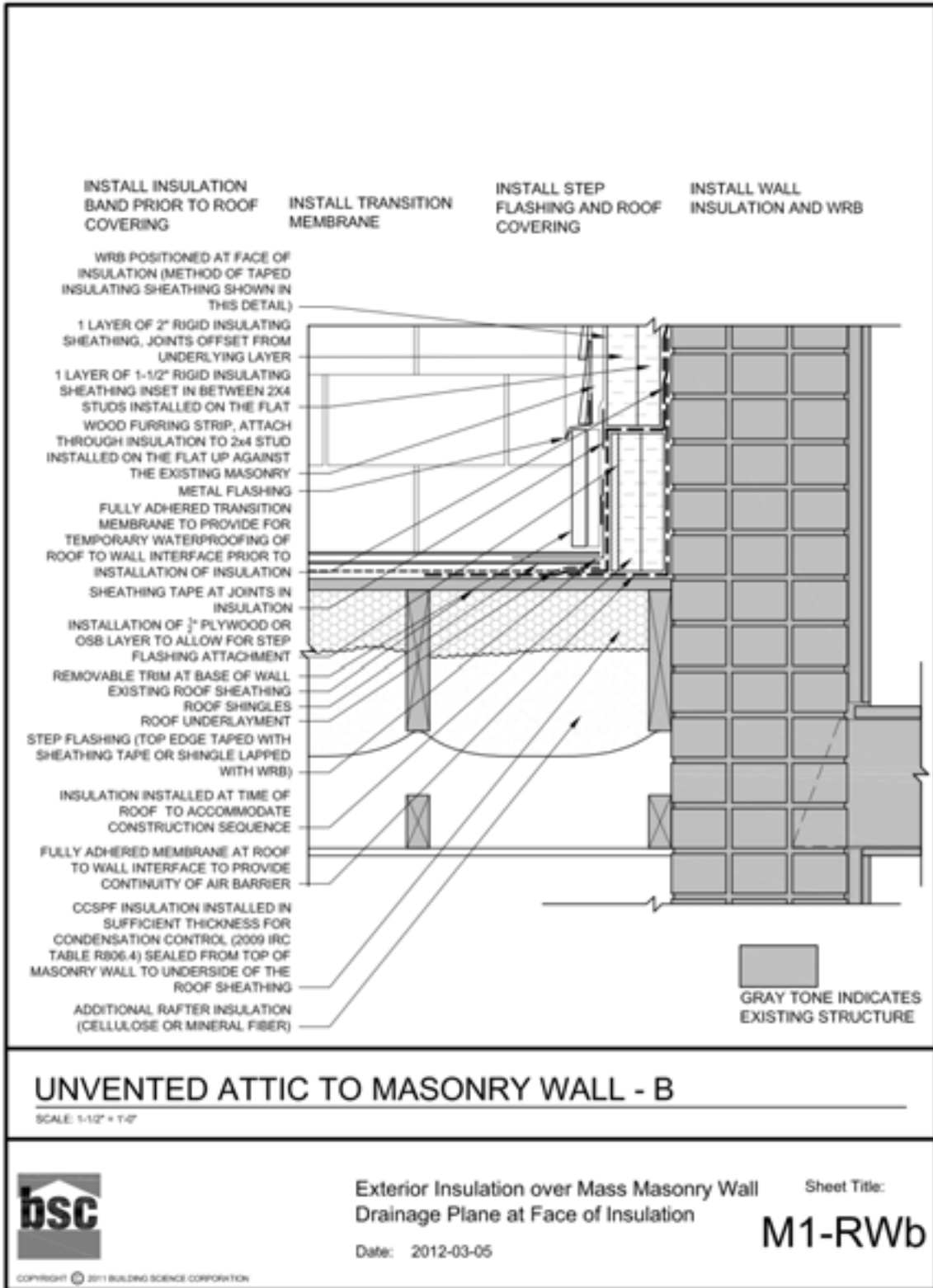

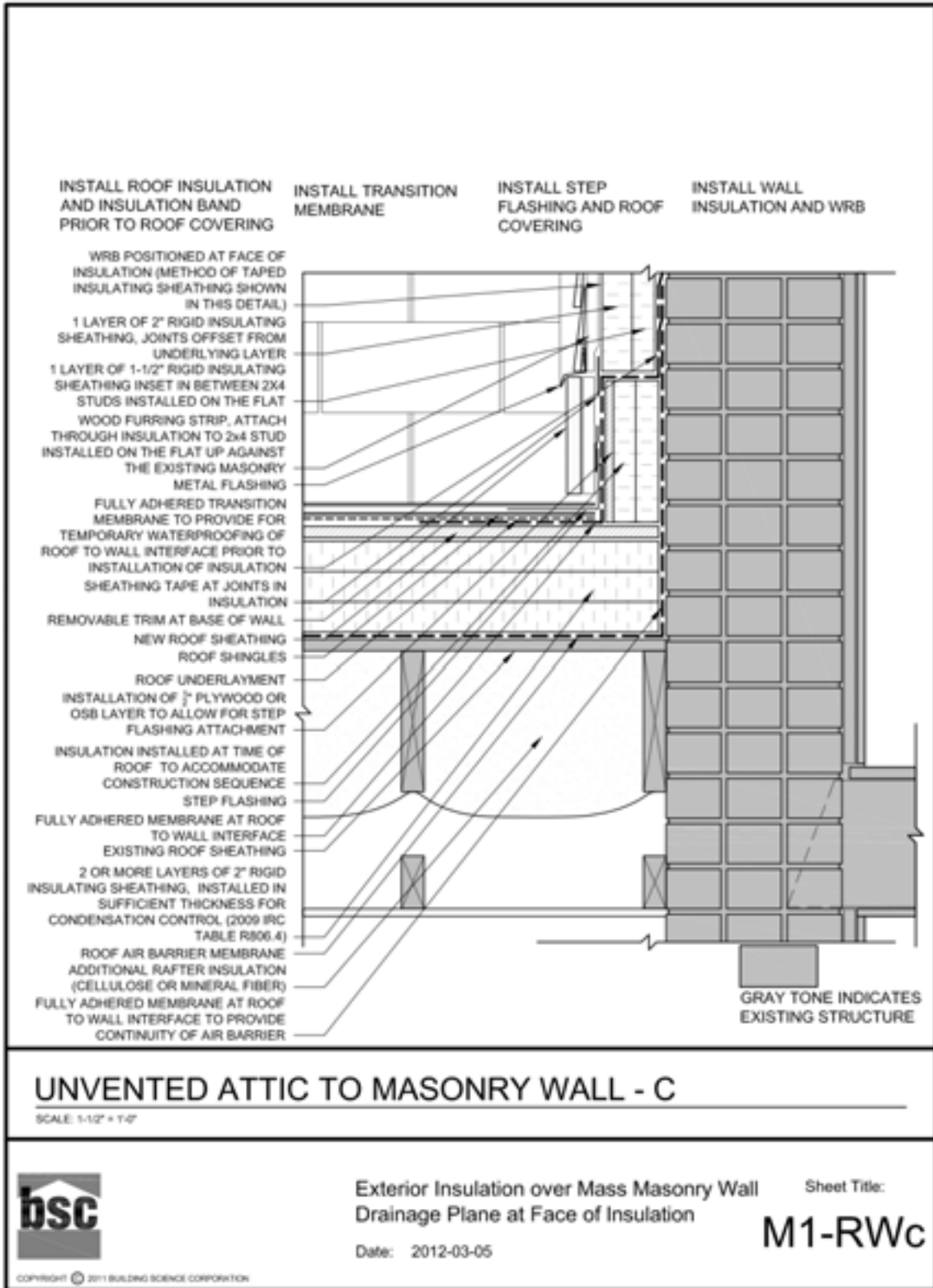

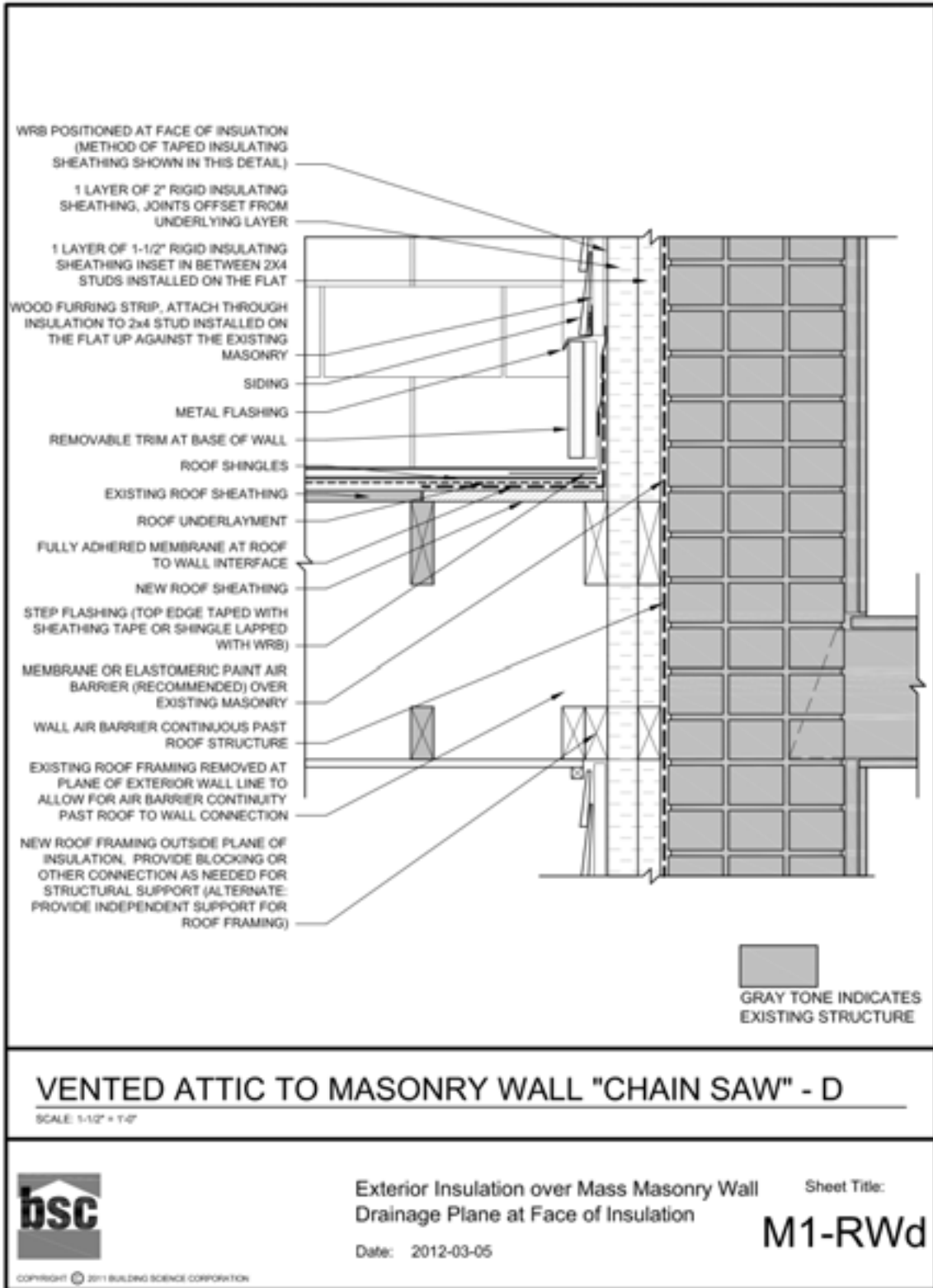

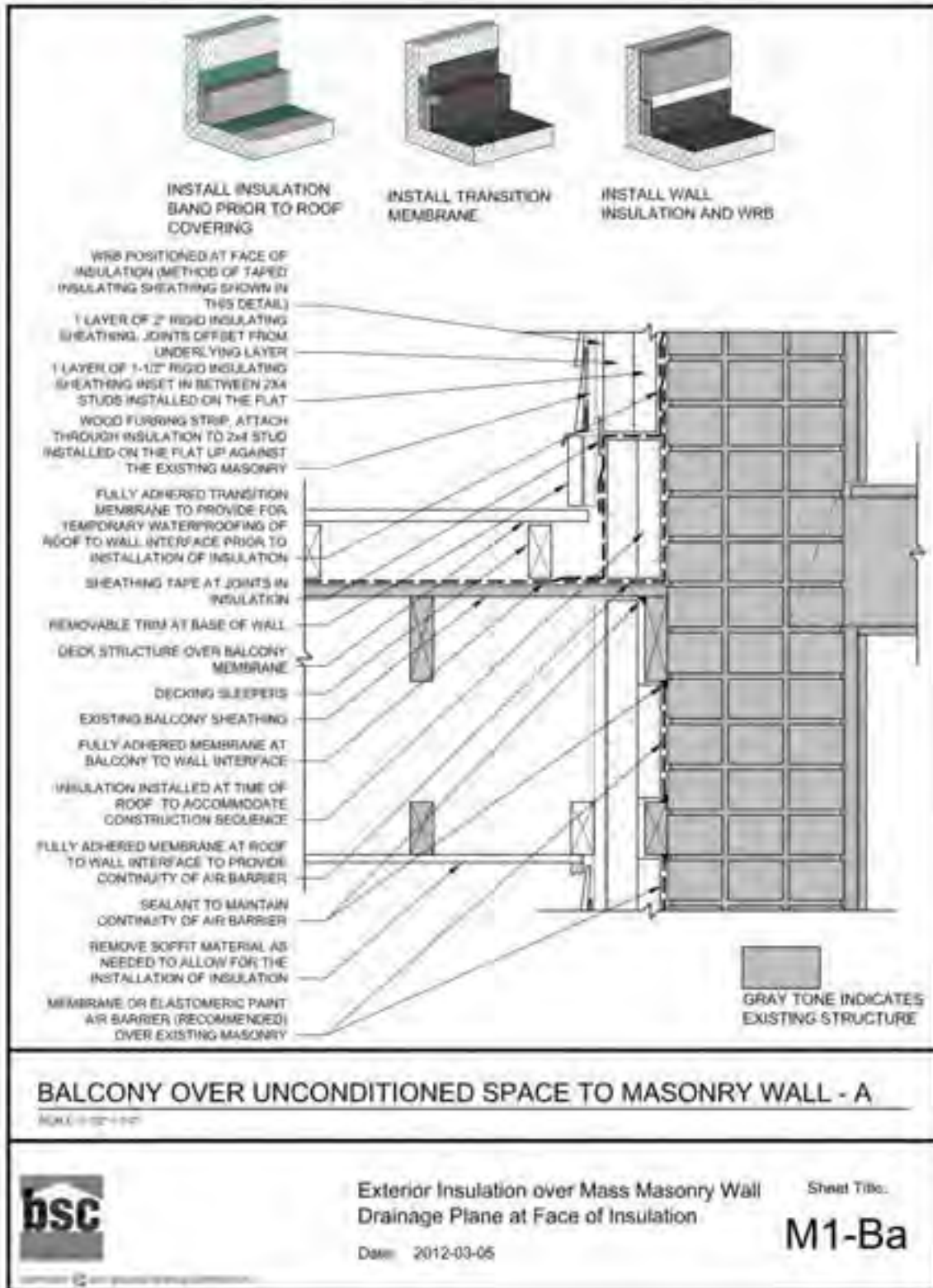

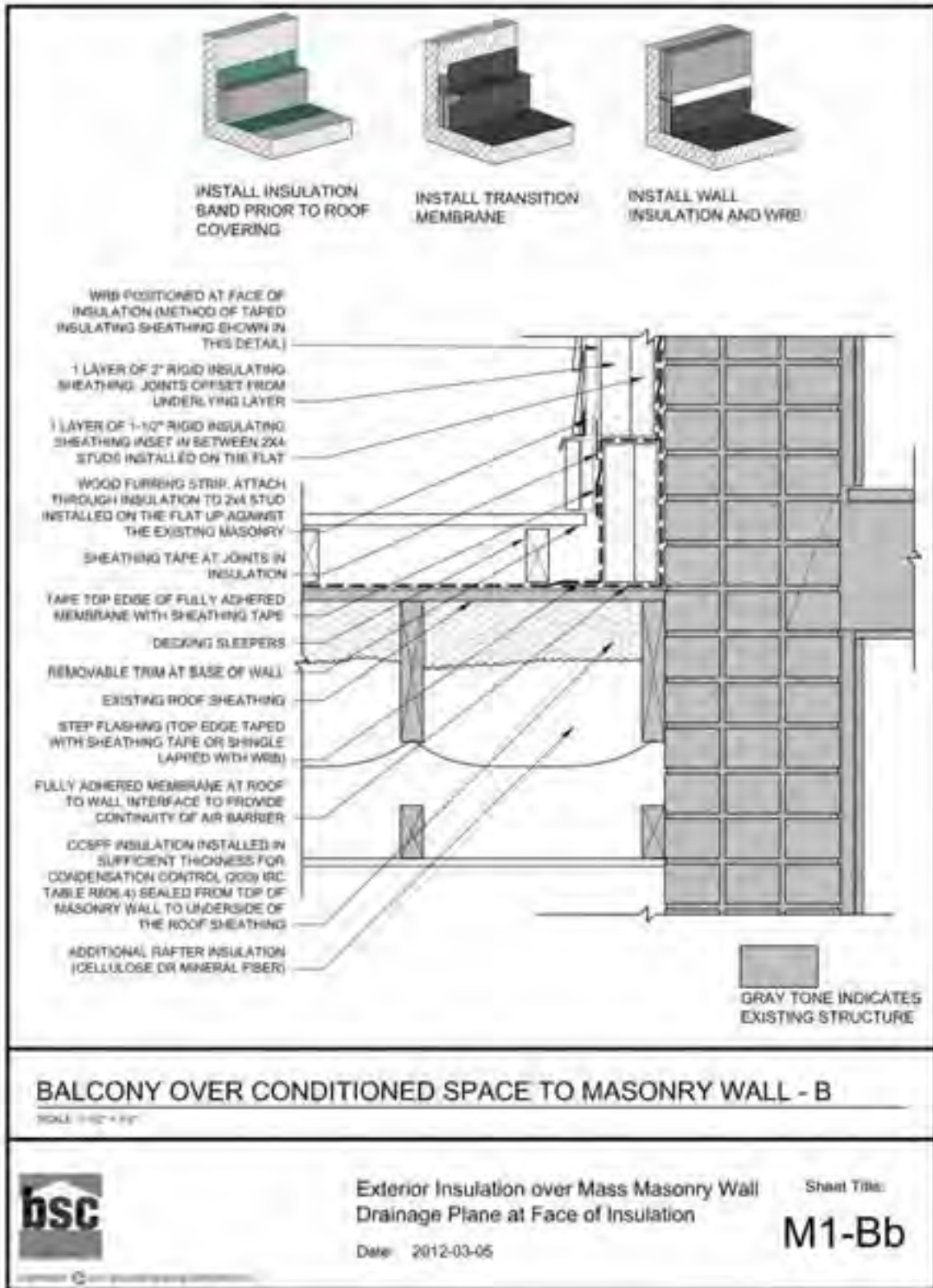

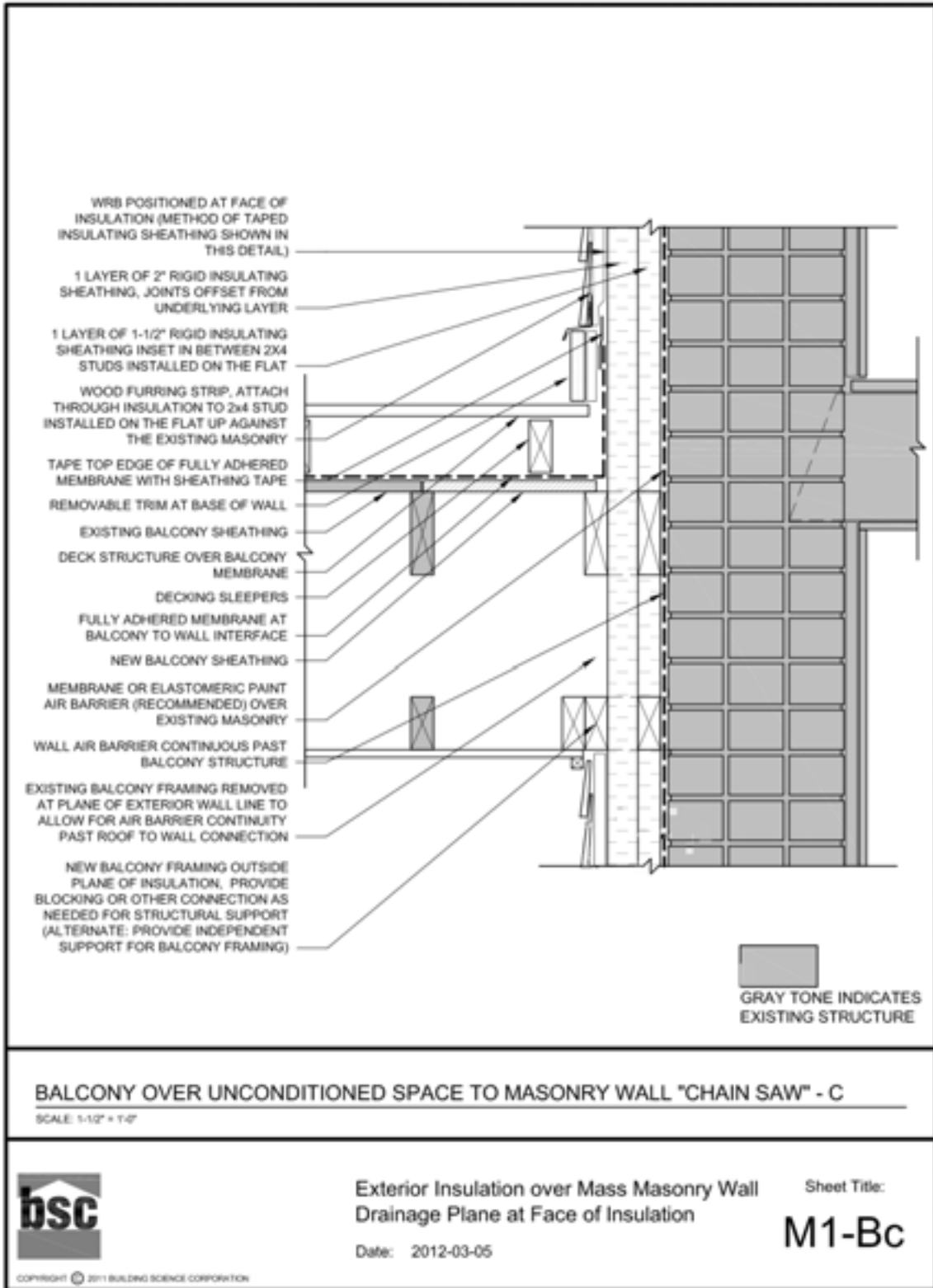

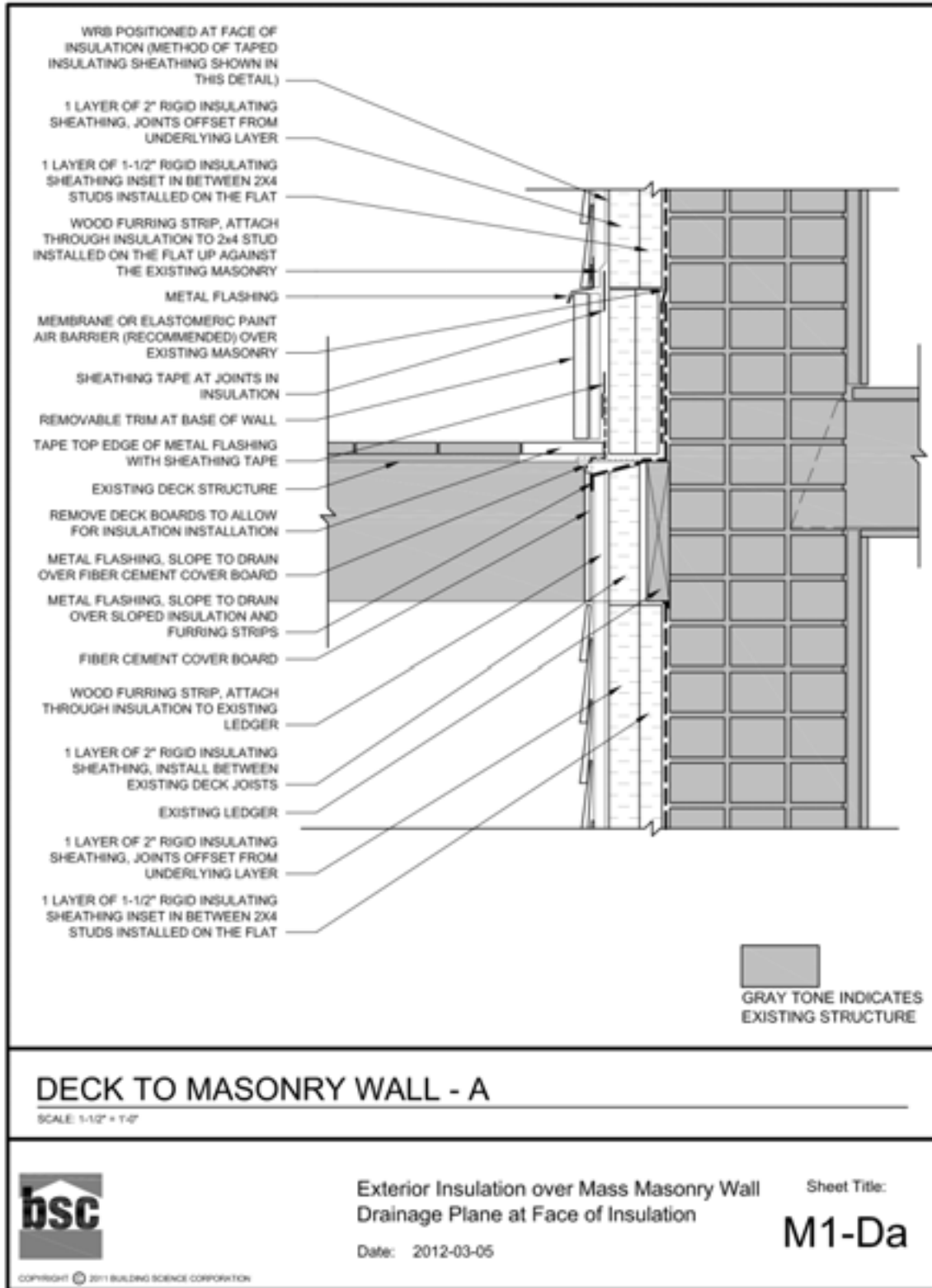

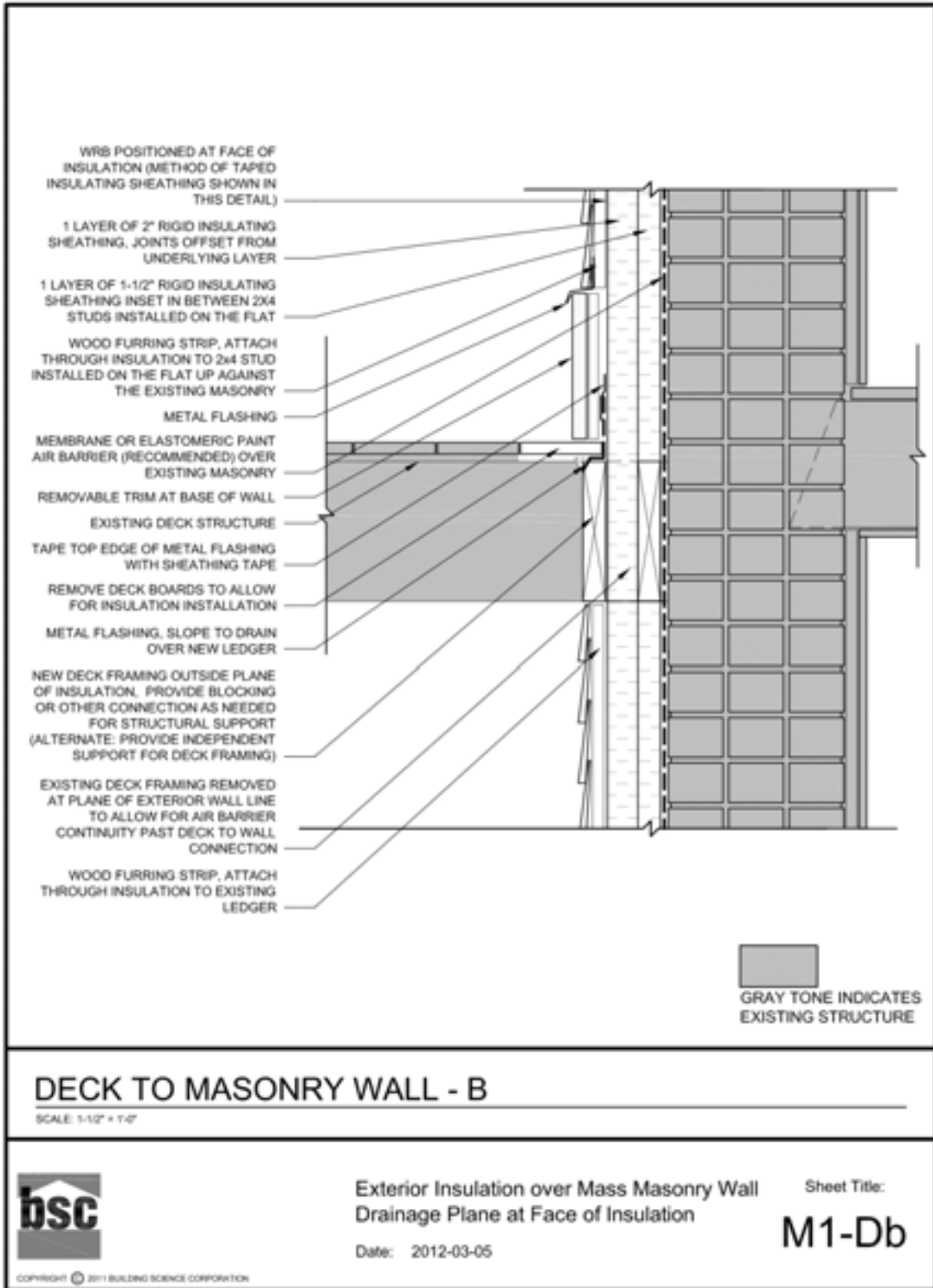

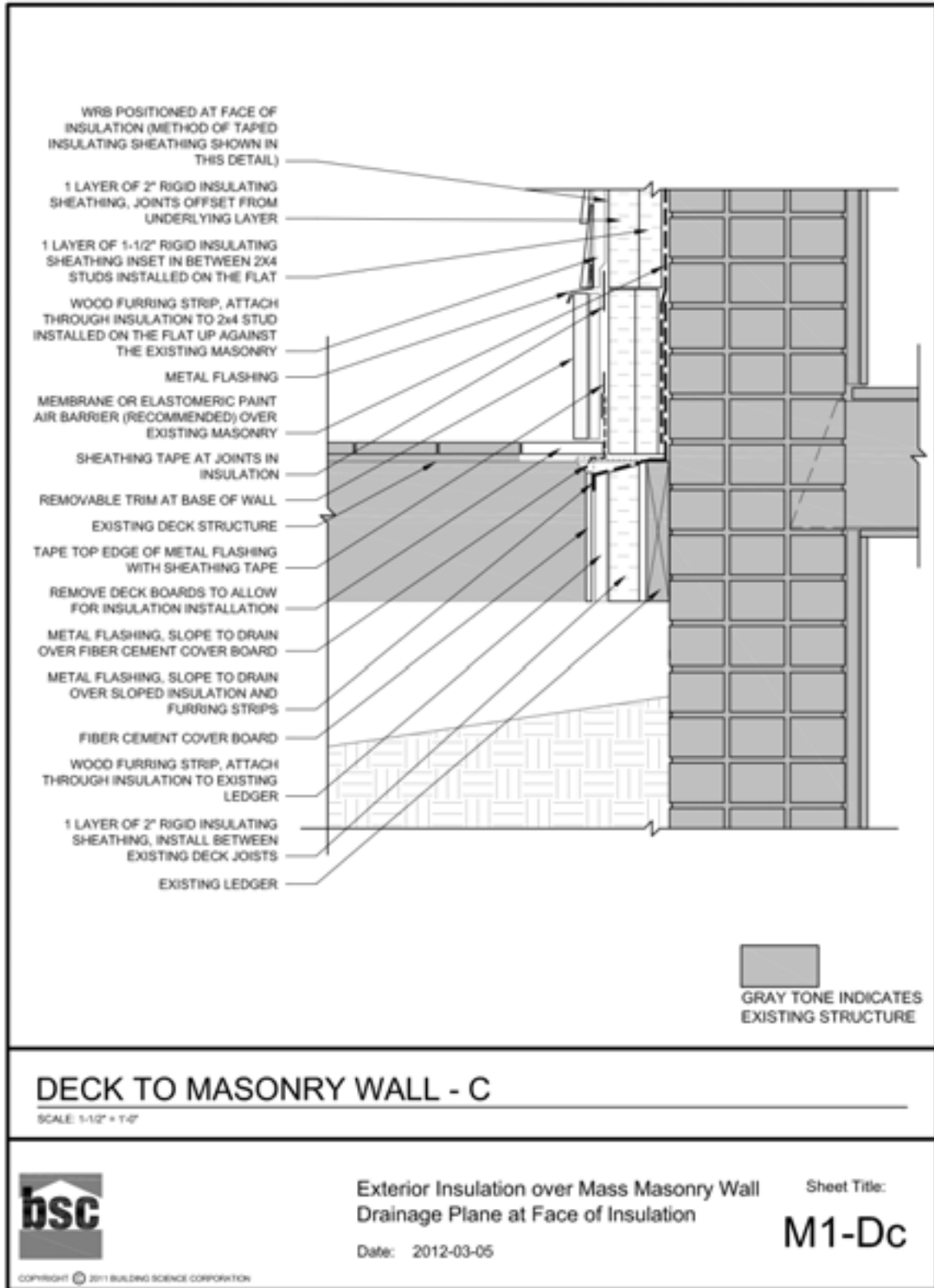

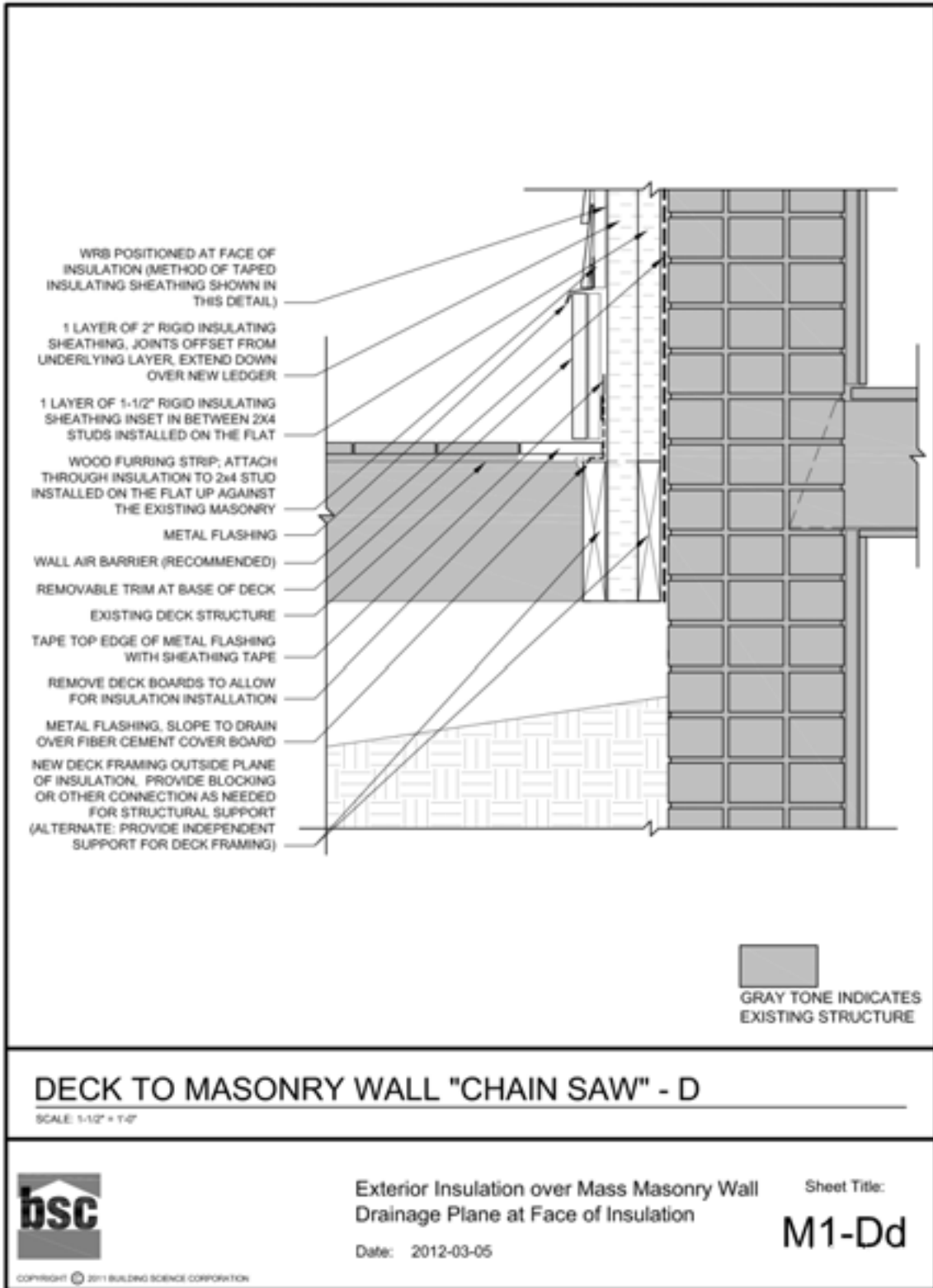

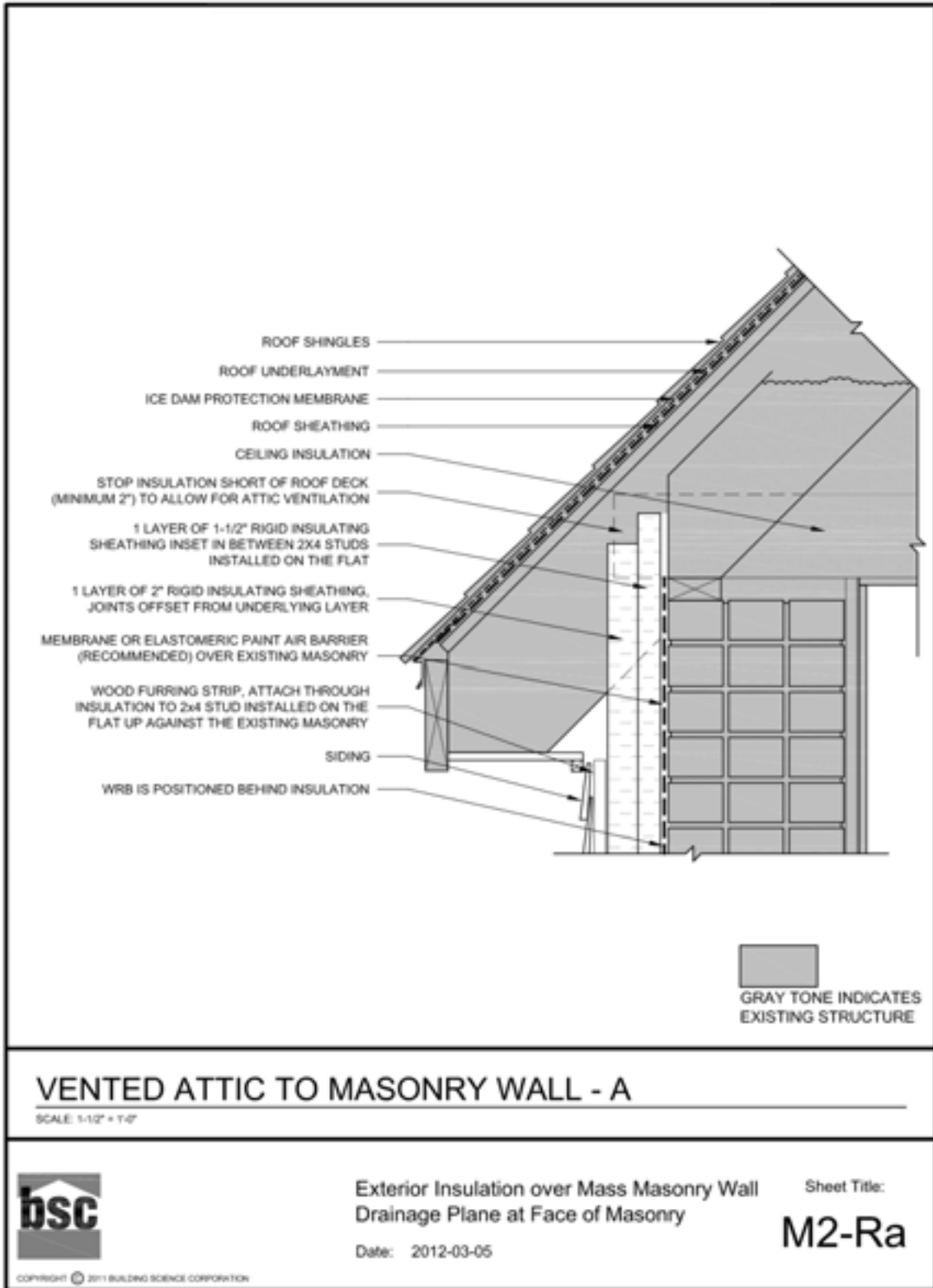

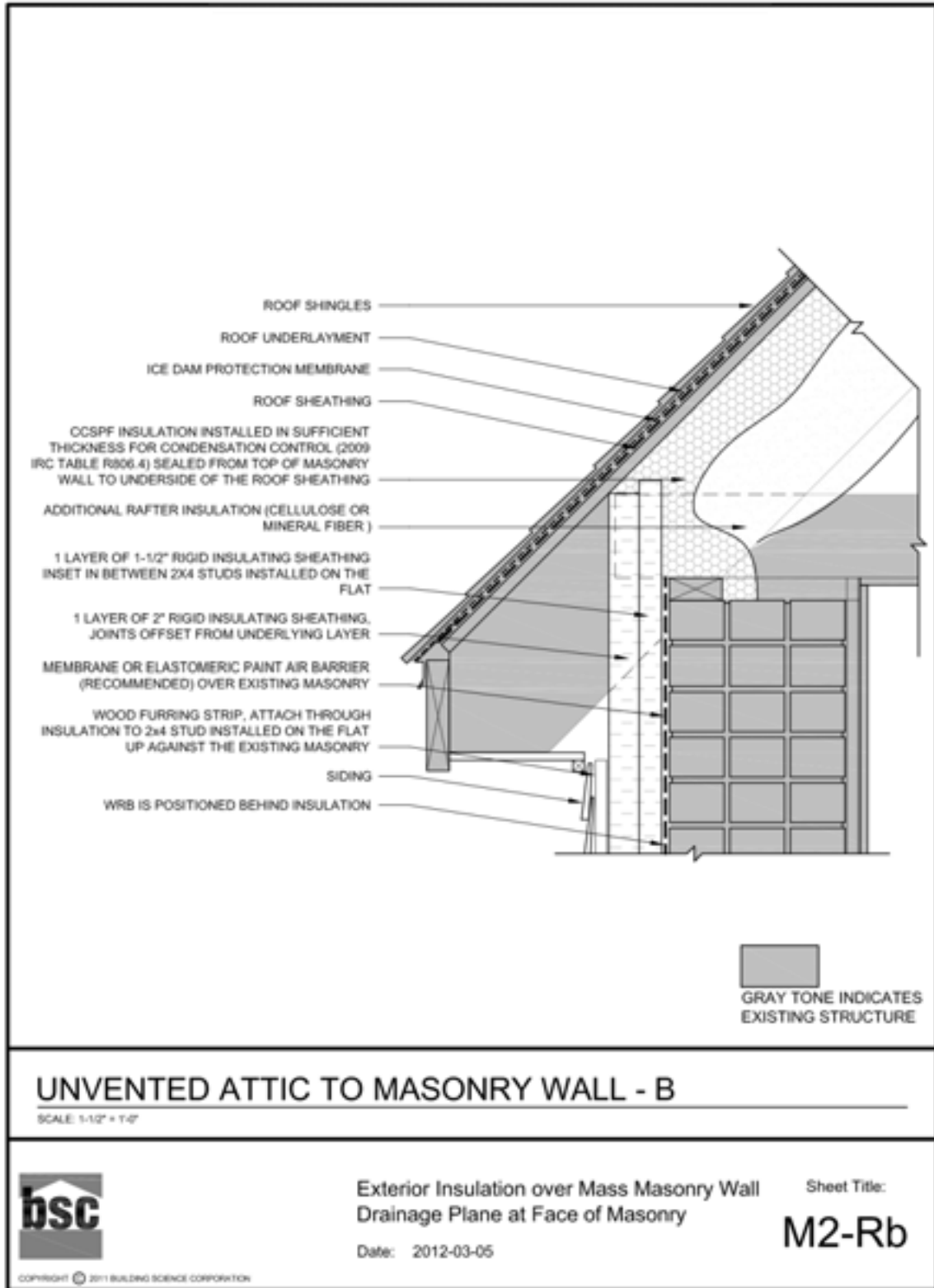

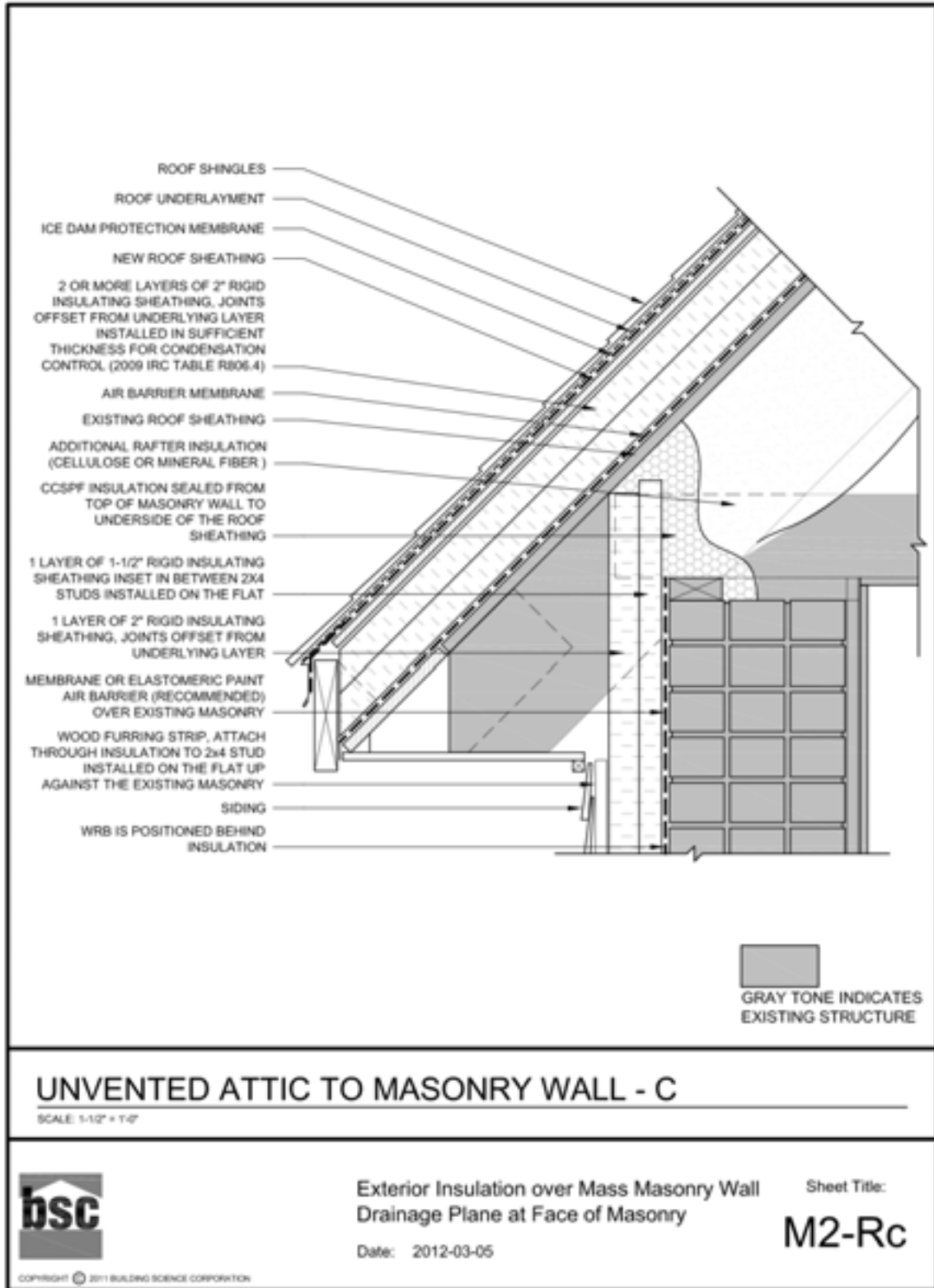

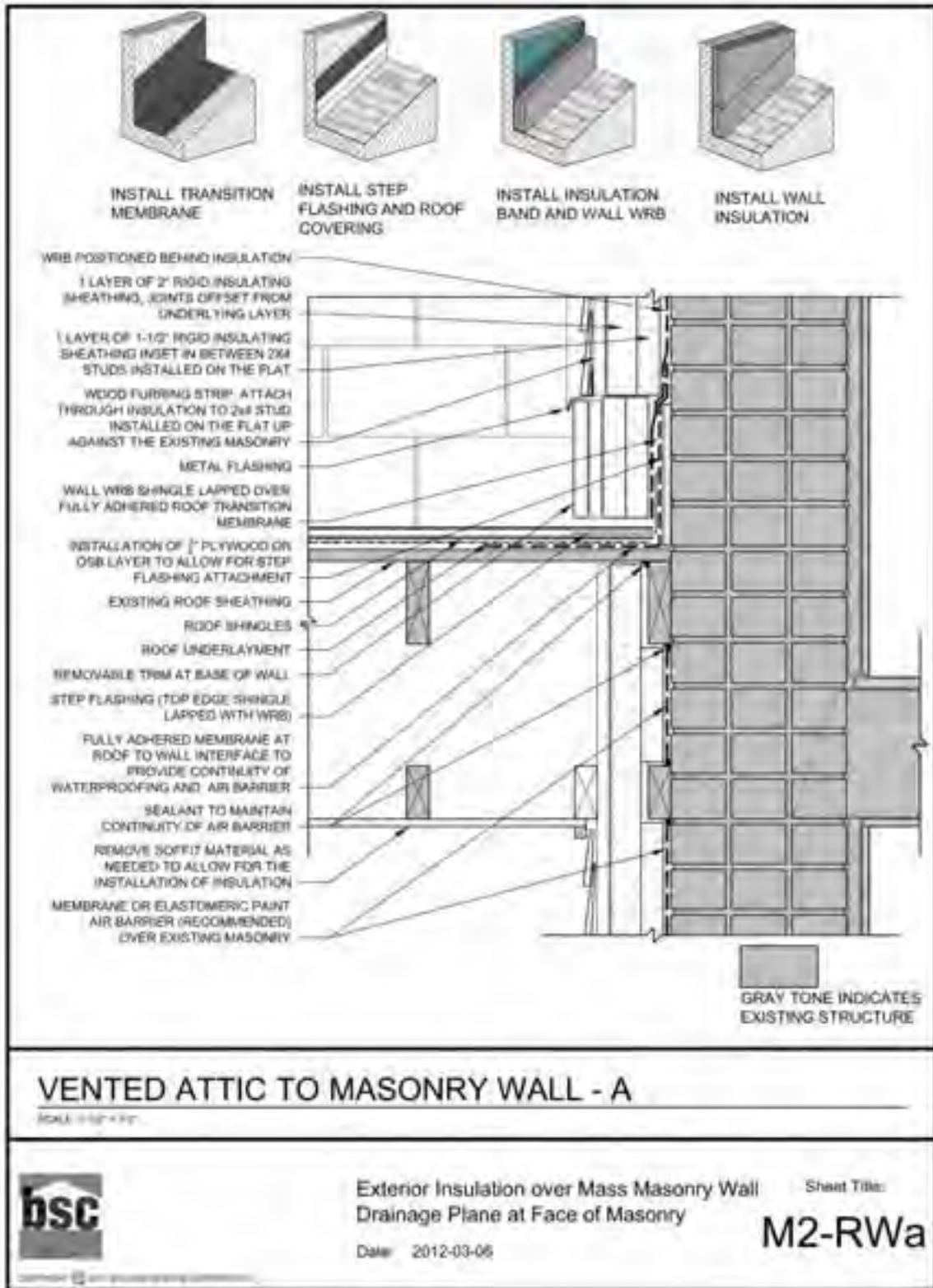

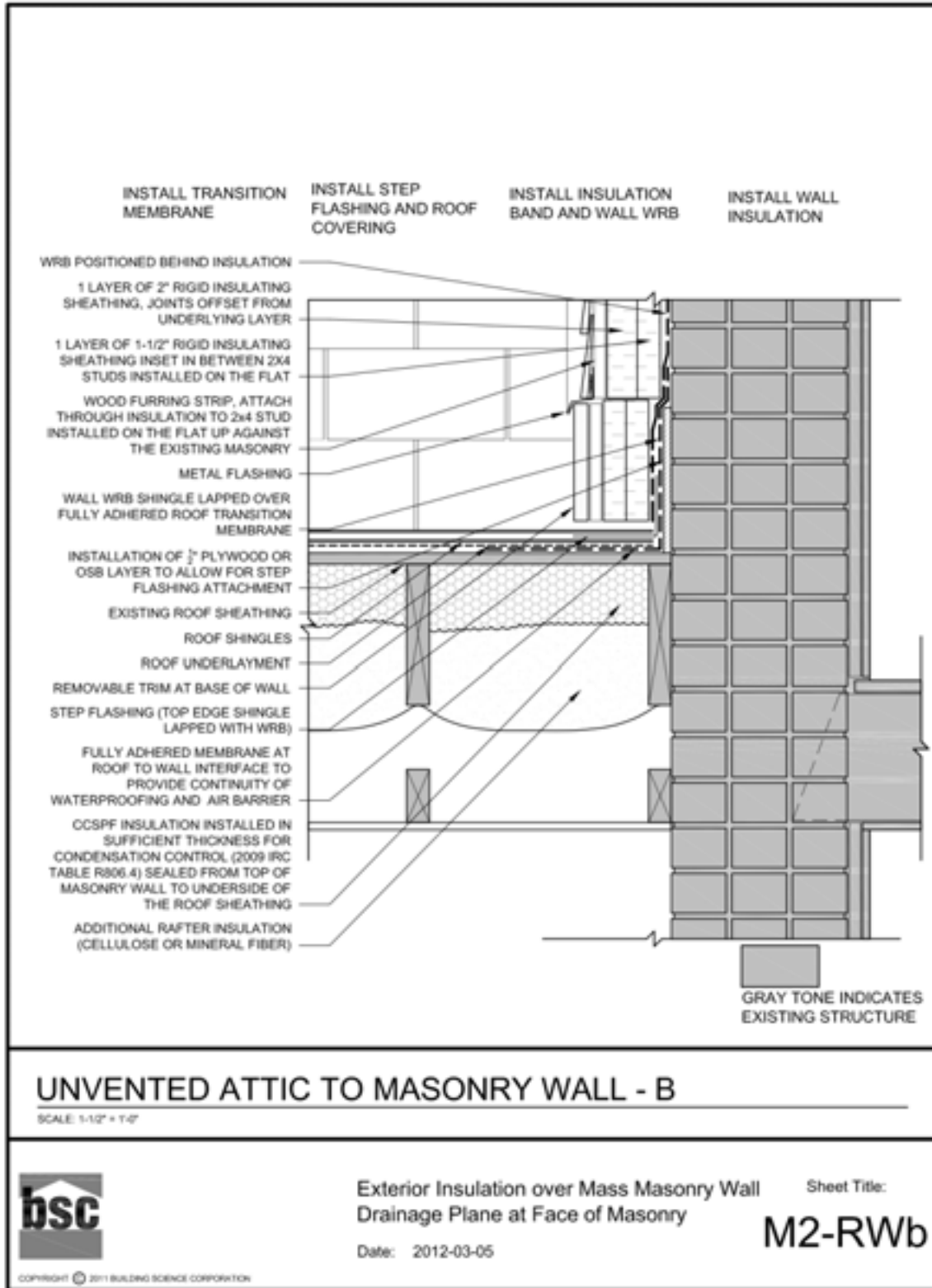

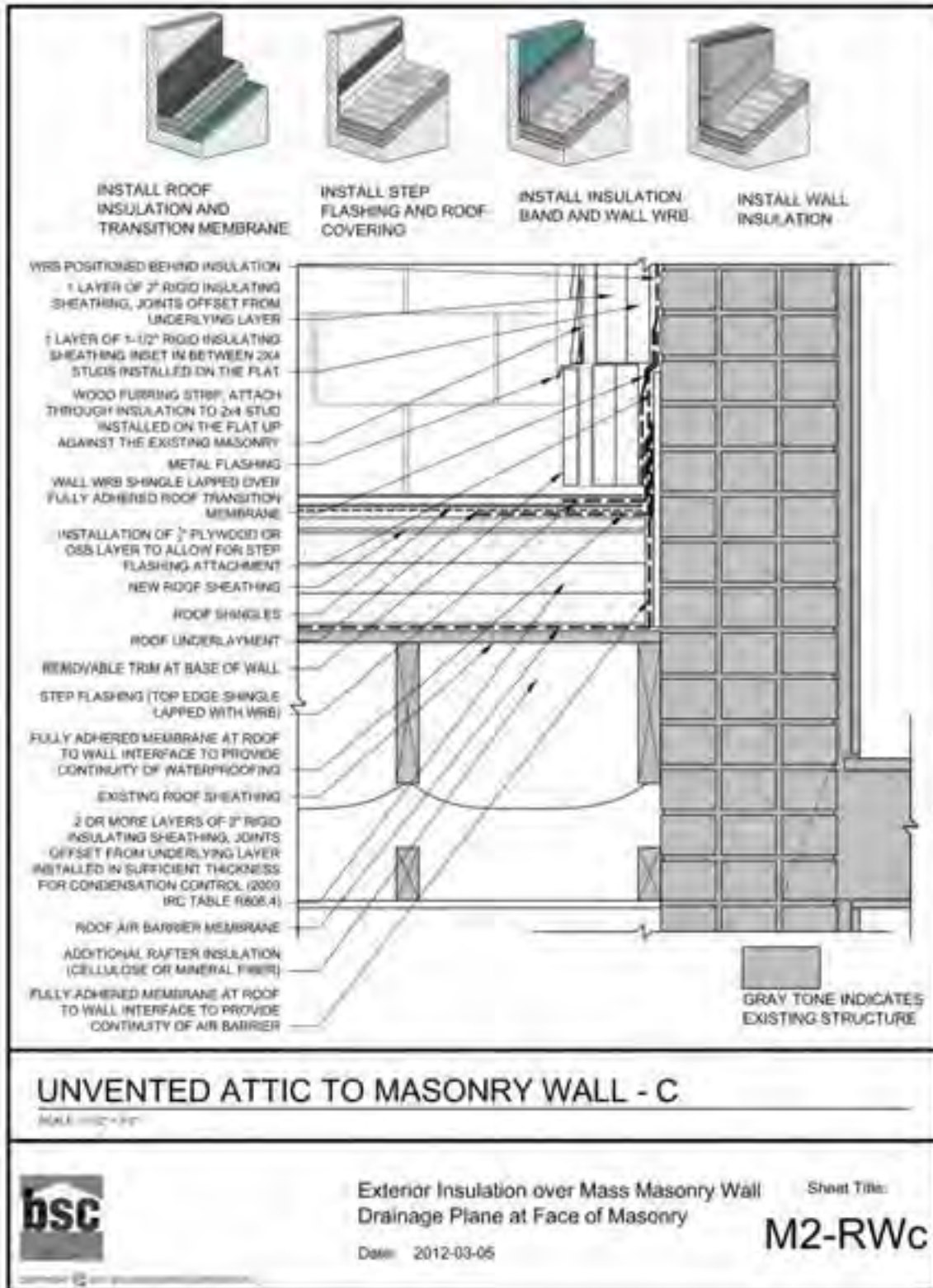

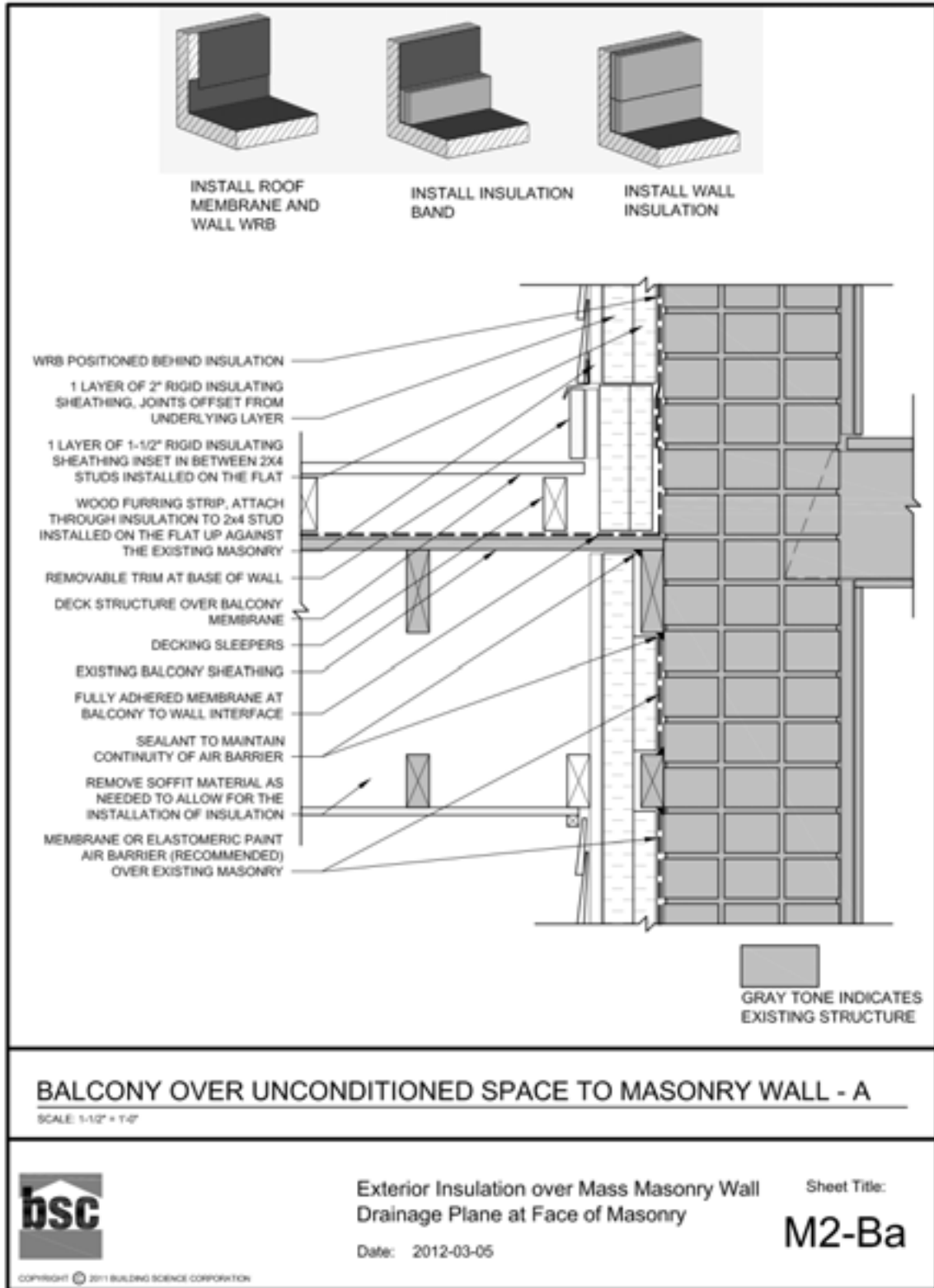

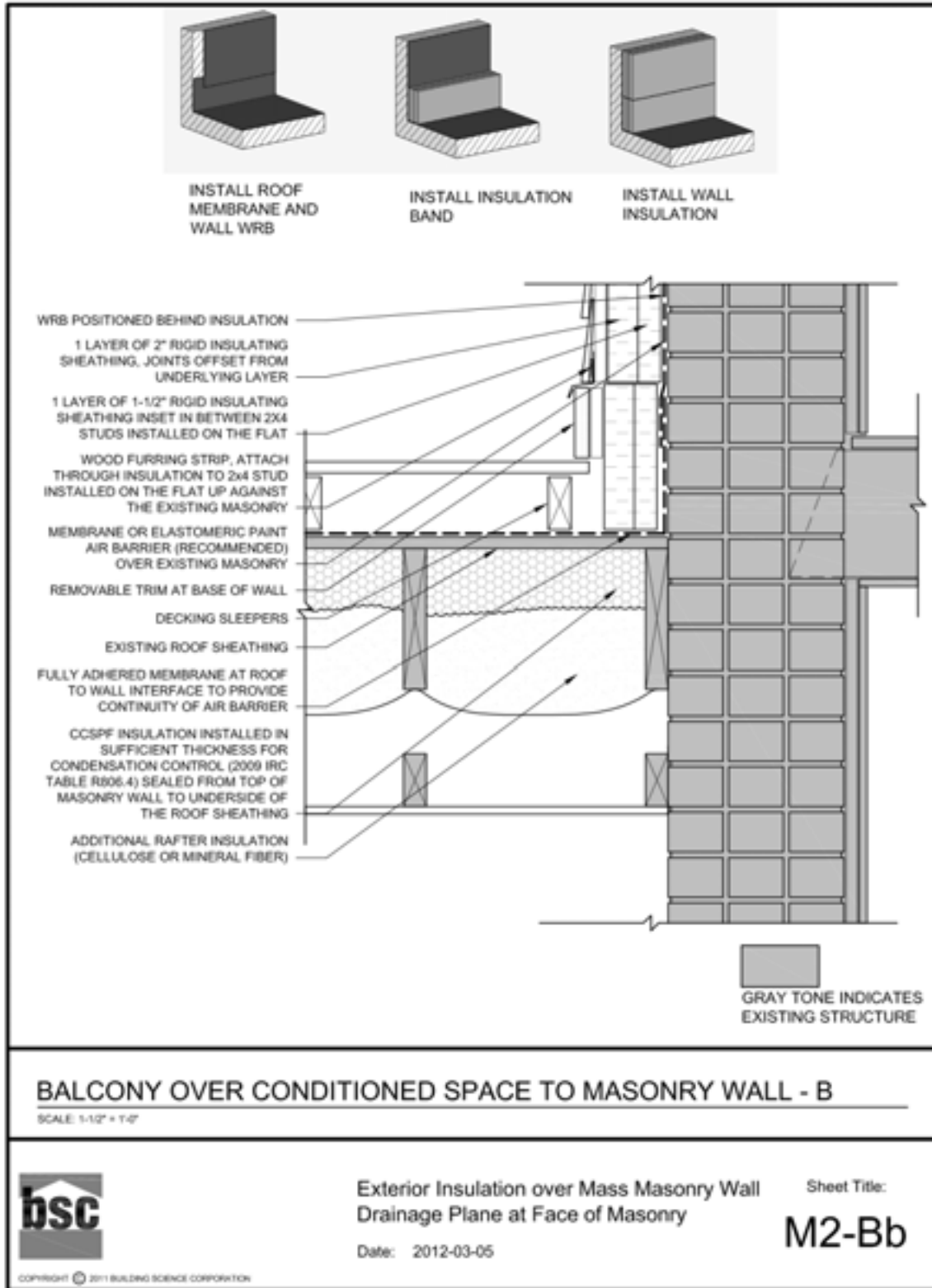

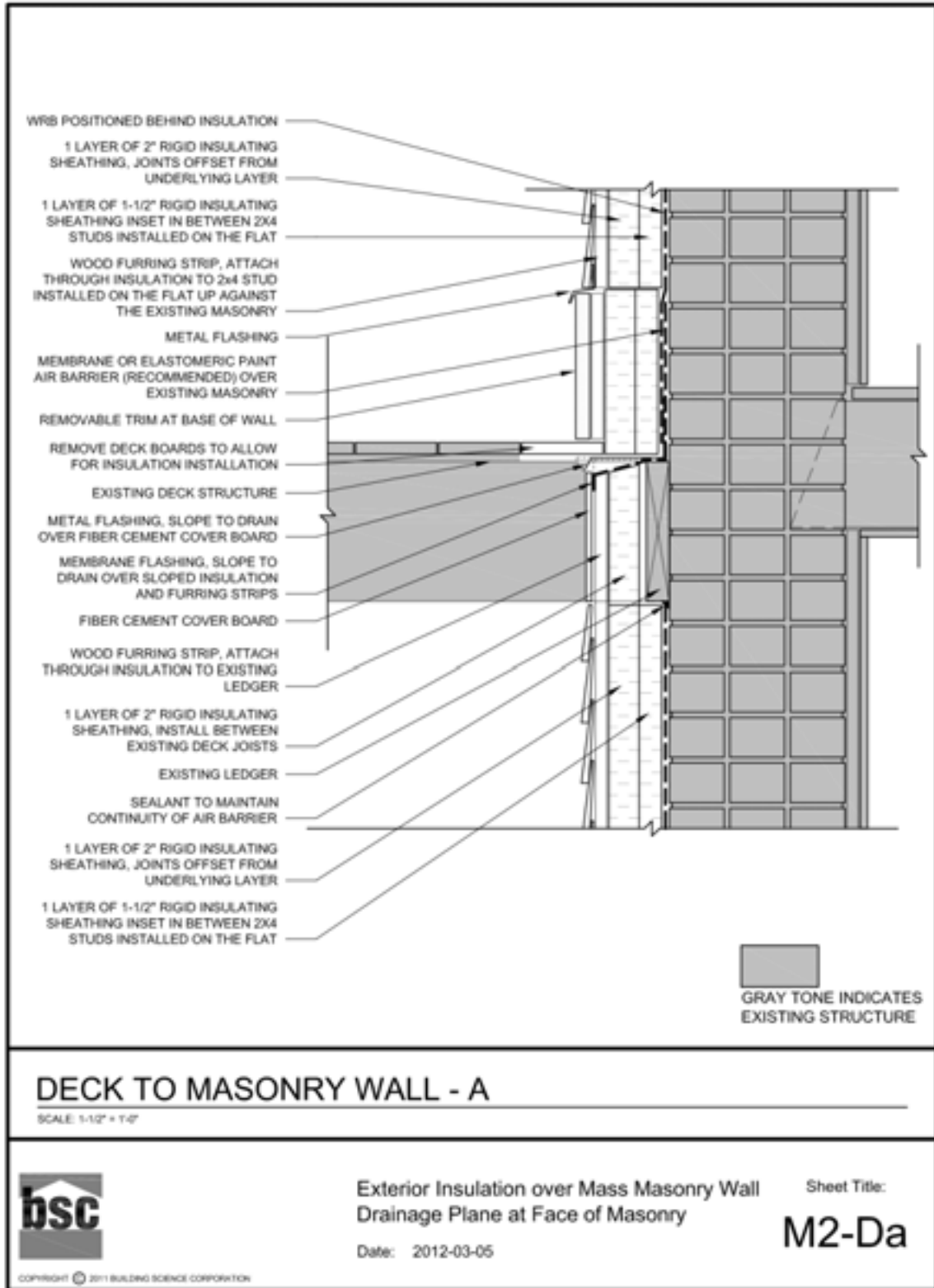

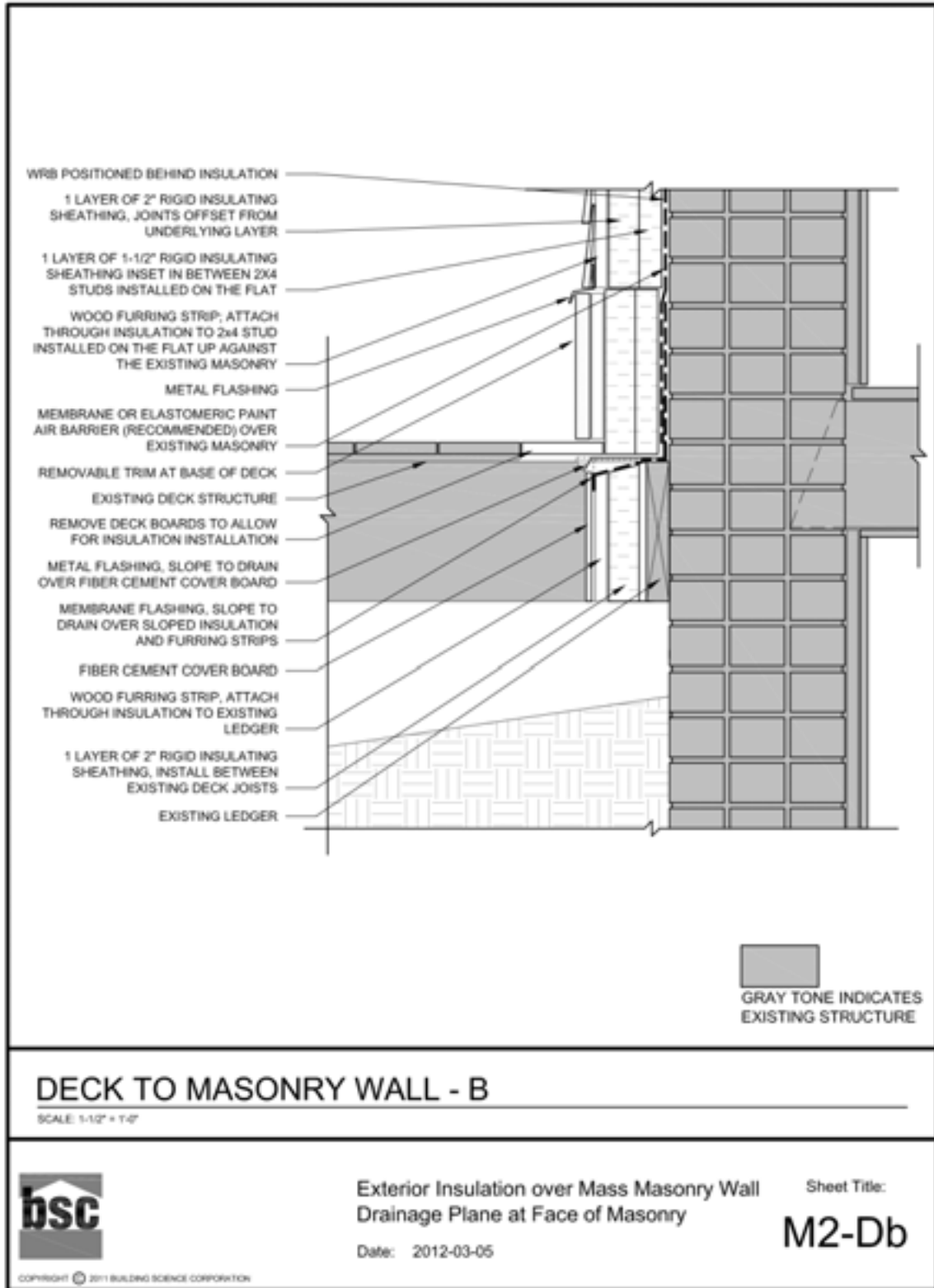

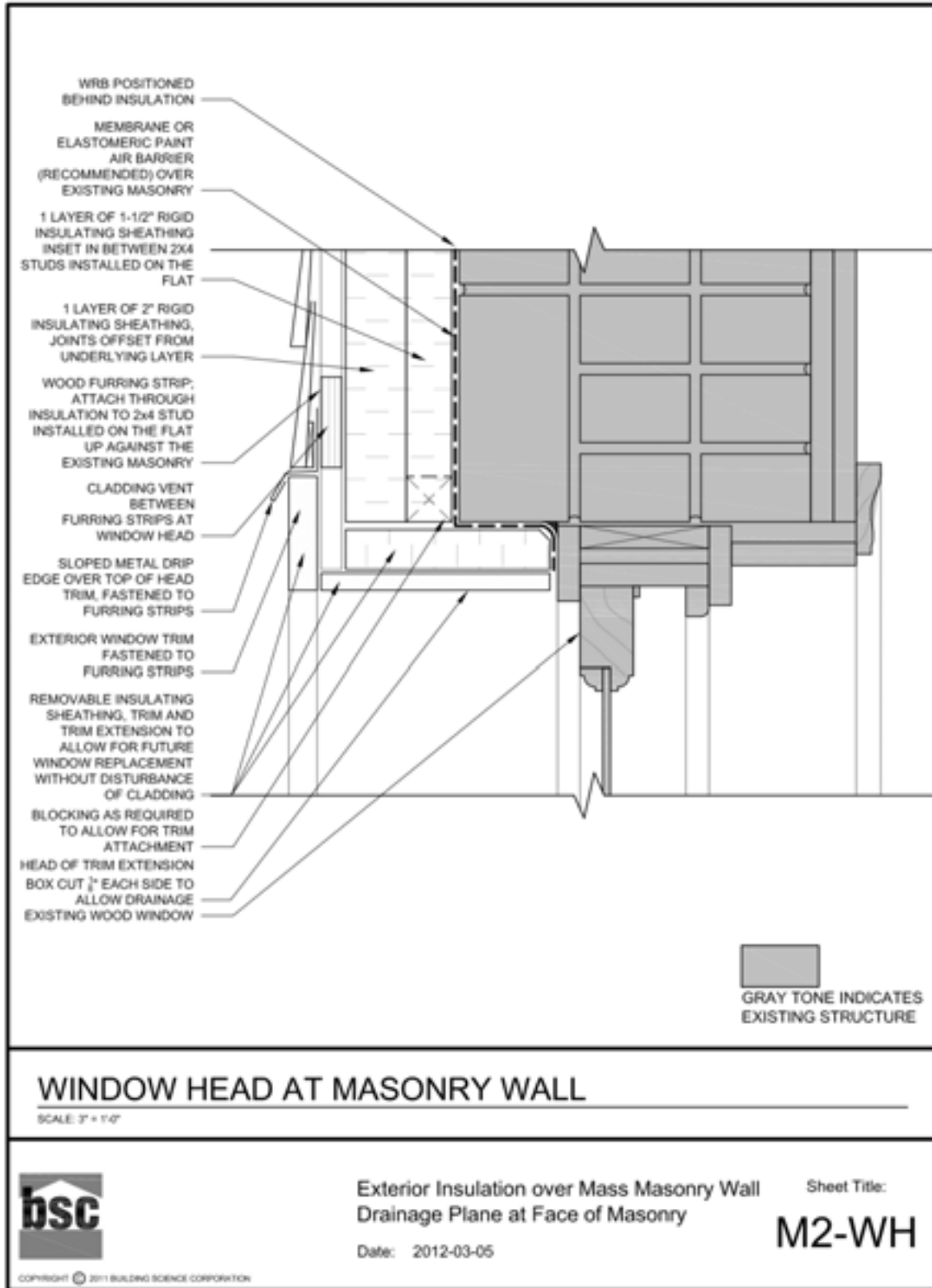

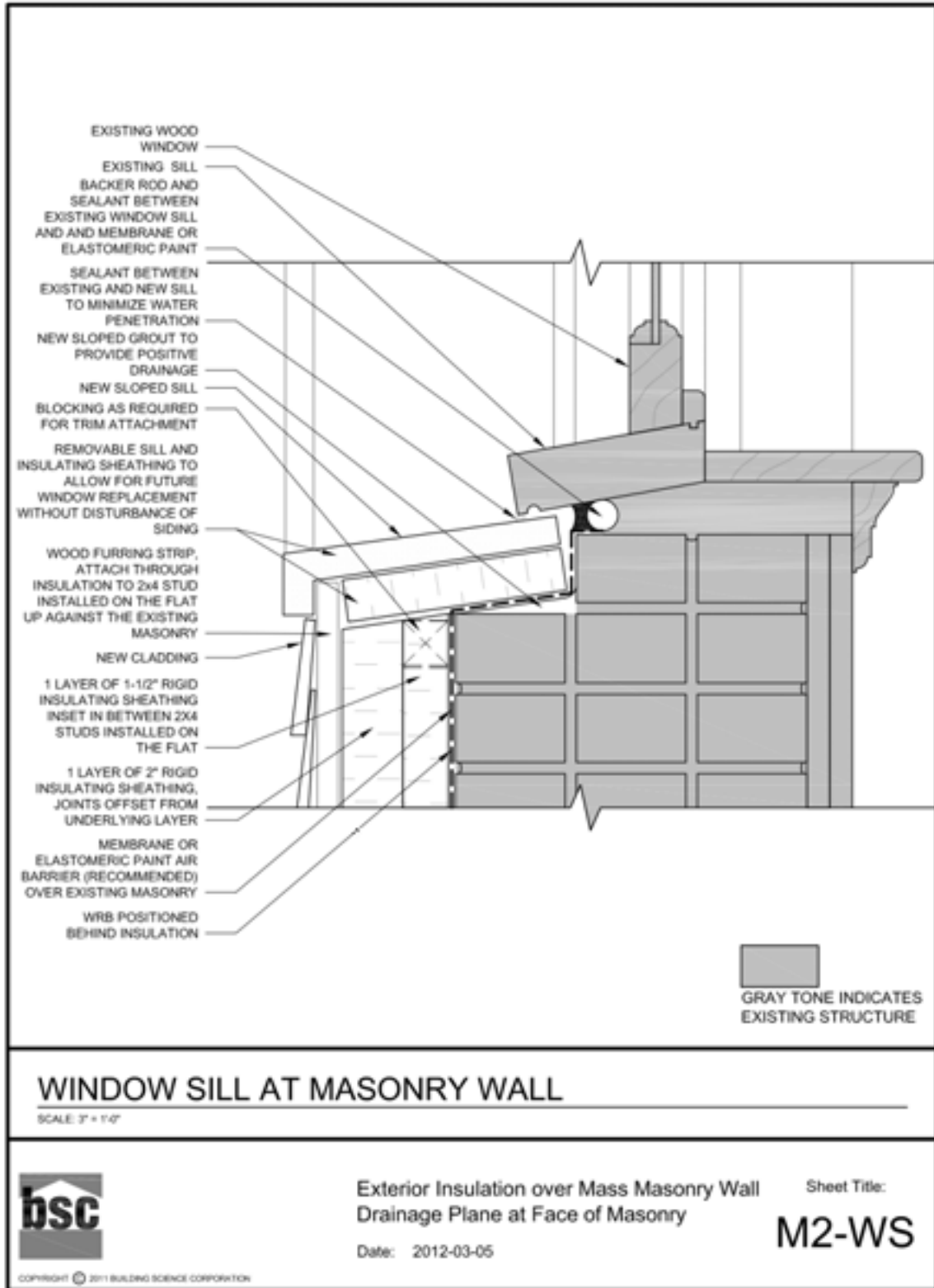

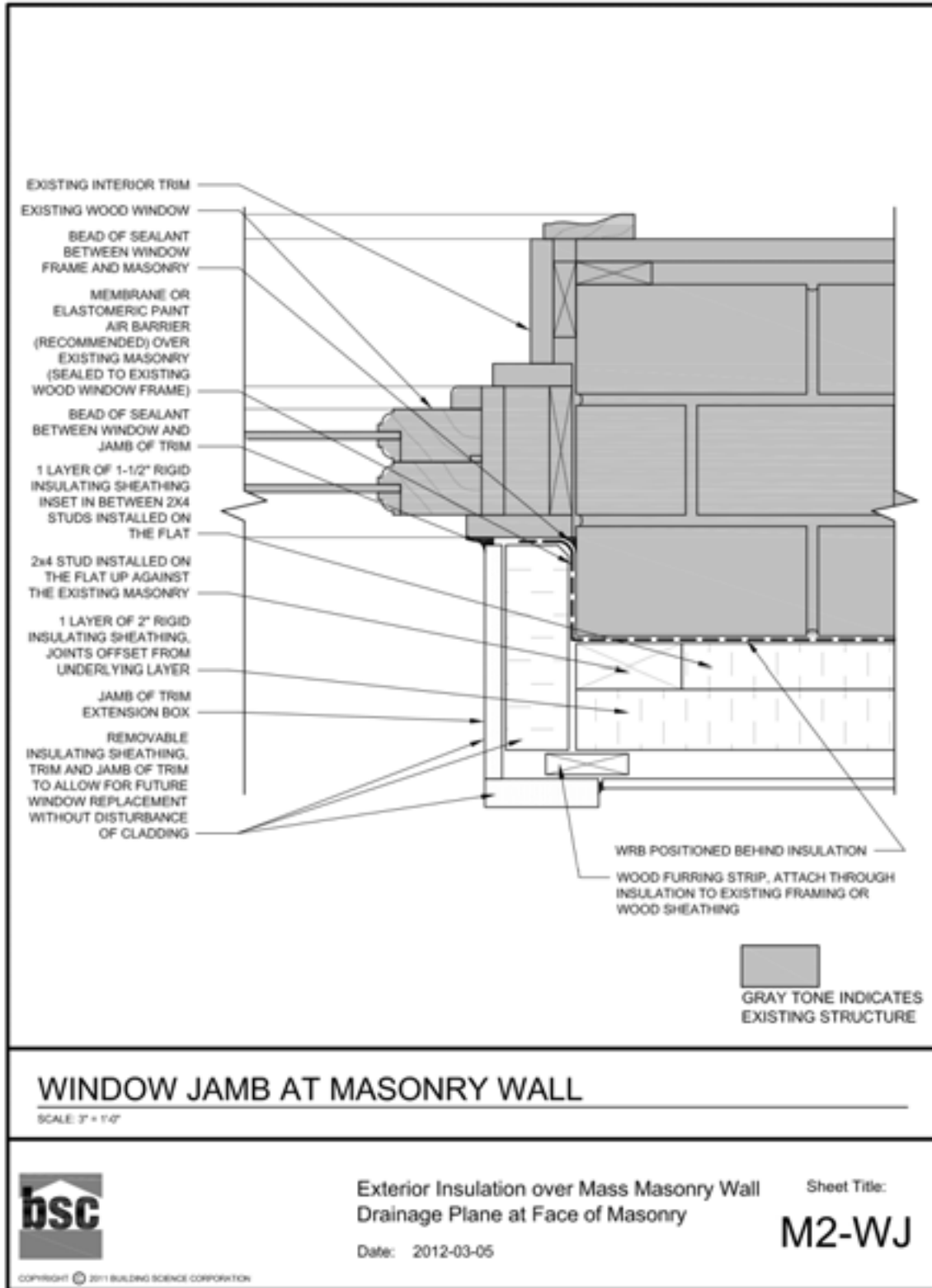

Appendix B: BEopt Simulation Graphs

B.1 Dallas, Texas

Utility Rates: \$0.13/kWh, \$1.09/therm

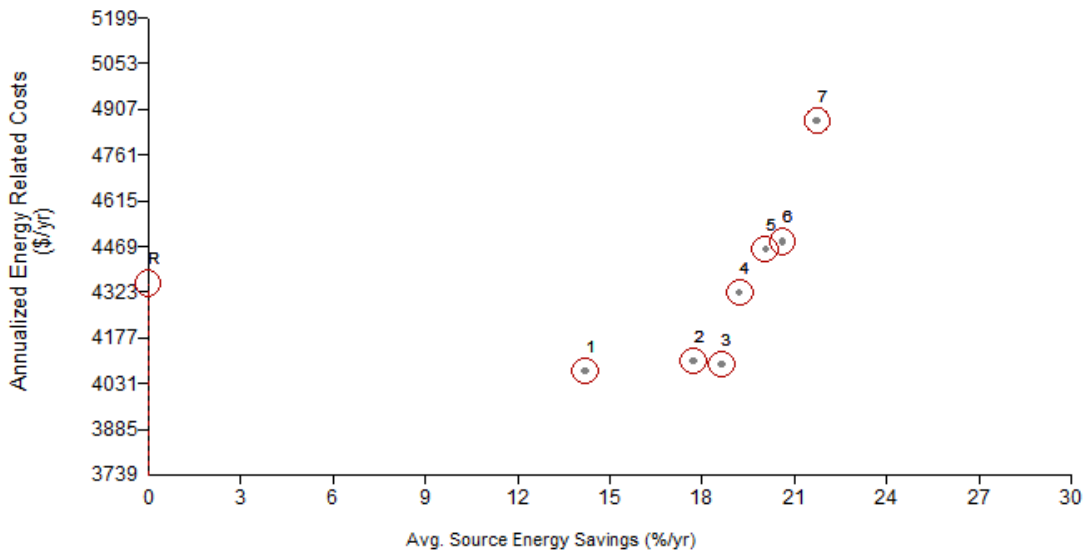

Figure 22. Annualized energy related costs versus average source energy savings for Dallas, Texas

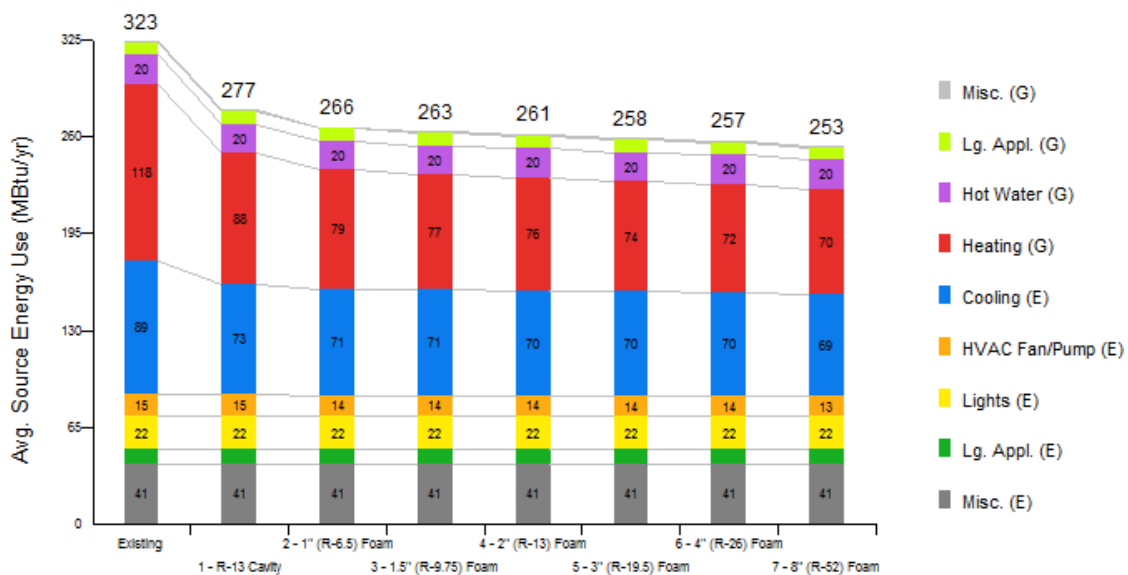

Figure 23. Average source energy savings reduction versus insulation level for Dallas, Texas

B.2 Kansas City, Missouri

Utility Rates: \$0.08/kWh, \$1.23/therm

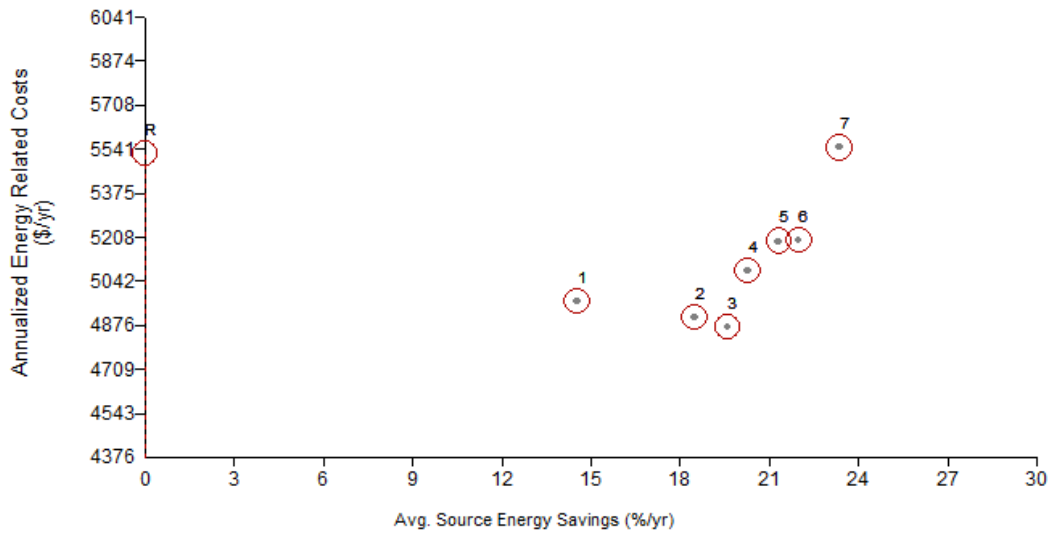

Figure 24. Annualized energy related costs versus average source energy savings for Kansas City, Missouri

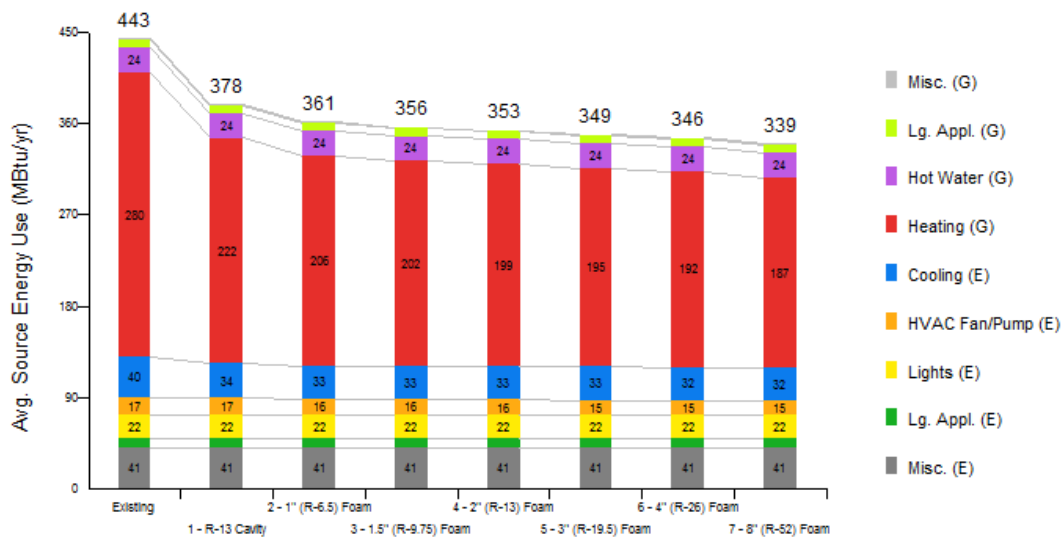

Figure 25. Average source energy savings reduction versus insulation level for Kansas City, Missouri

B.3 Boston, Massachusetts

Utility Rates: \$0.18/kWh, \$1.70/therm

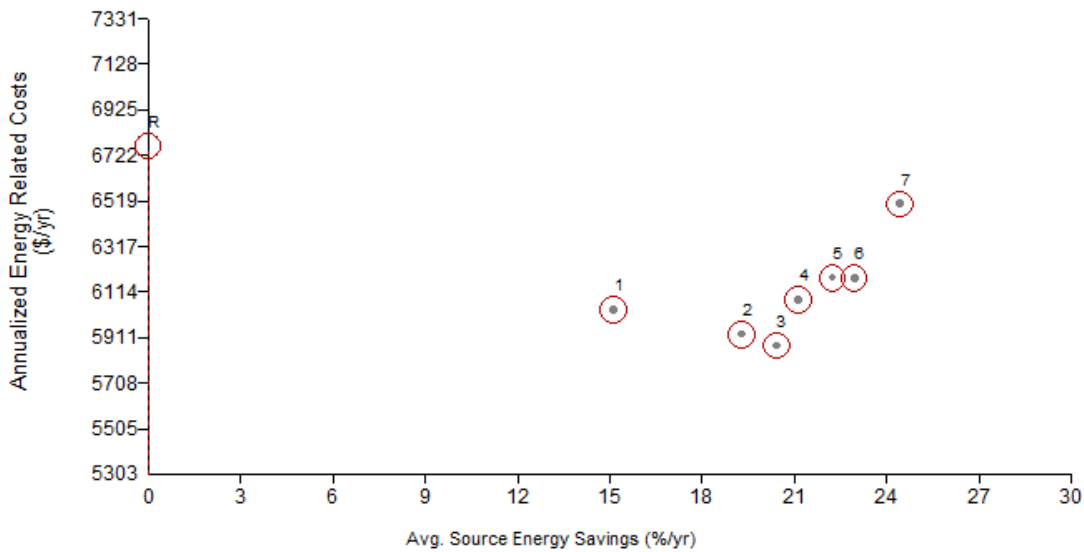

Figure 26. Annualized energy related costs versus average source energy savings for Boston, Massachusetts

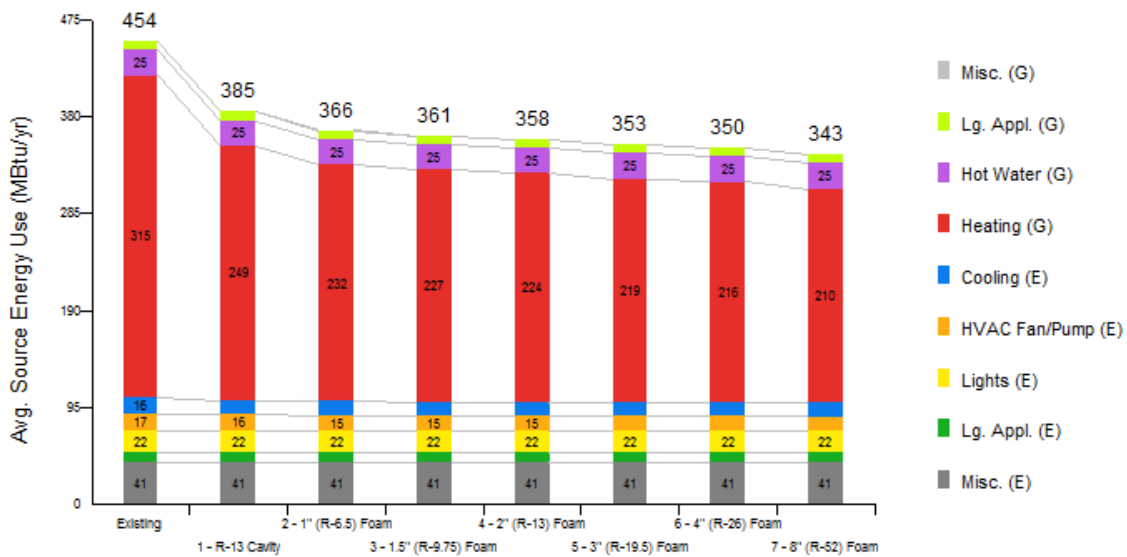

Figure 27. Average source energy savings reduction versus insulation level for Boston, Massachusetts

B.4 Duluth, Minnesota

Utility Rates: \$0.10/kWh, \$0.87/therm

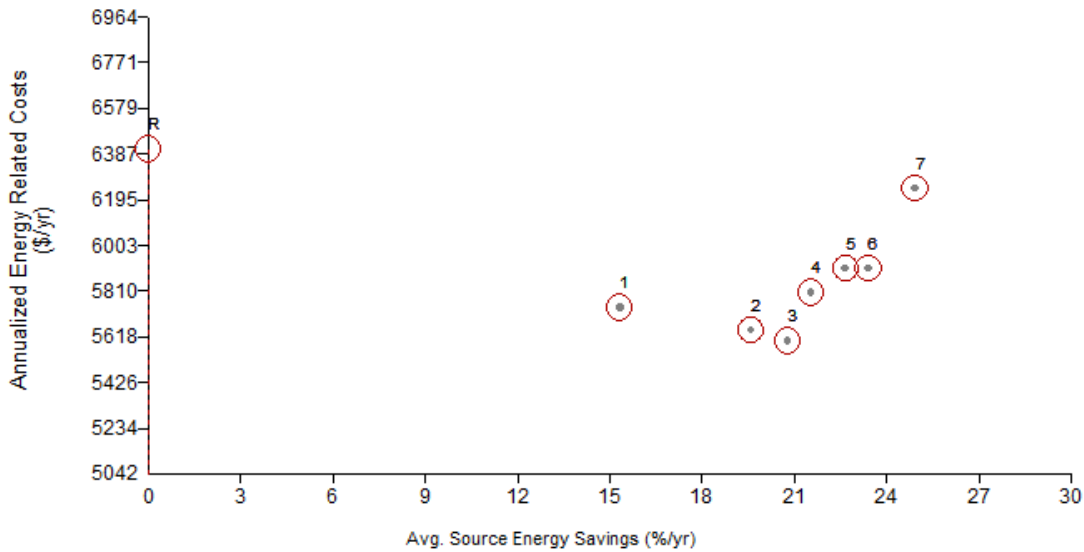

Figure 28. Annualized energy related costs versus average source energy savings for Duluth, Minnesota

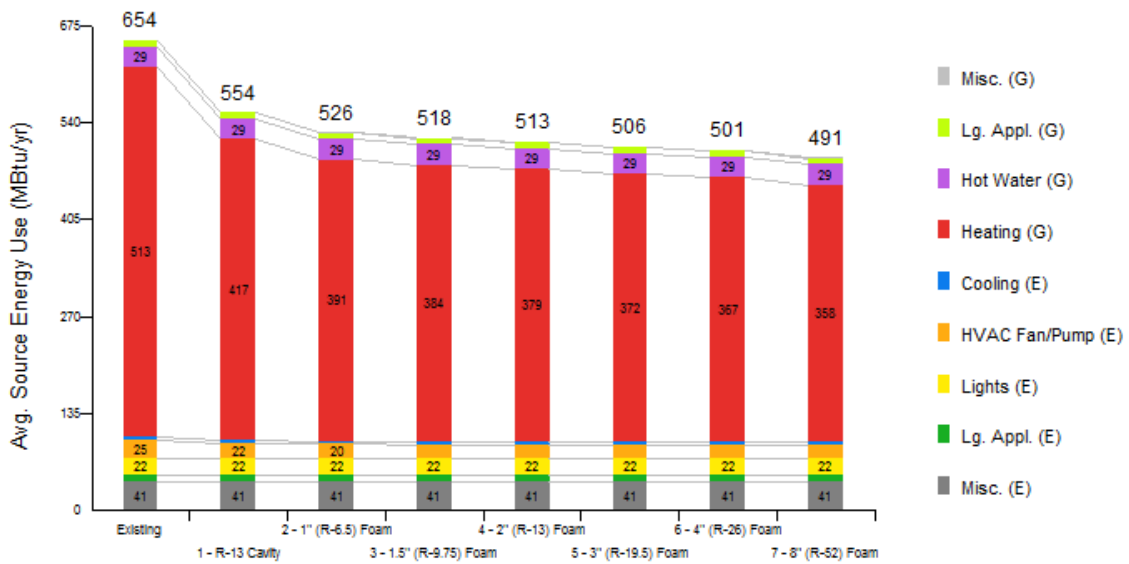

Figure 29. Average source energy savings reduction versus insulation level for Duluth, Minnesota

Appendix C: Short-Term Deflection Test Protocol

C.1 Support Structure

A wood framed wall was constructed and anchored to the concrete masonry unit (CMU) wall with metal brackets on the side and top to minimize movement of the framed wall relative to the CMU wall during testing. The wood framed wall is used to support the insulation and strapping for testing. The support frame consisted of 2 × 4 studs spaced at 24-in. o.c. and single top and bottom plates. Standard OSB sheathing was screwed into the frame. Plastic house wrap was installed to accurately represent the majority of enclosure wall systems in the field.

C.2 Insulation and Furring Strips

The insulation was installed in either two layers of 2-in. material or four layers of 2-in. material depending on which test was being conducted. The insulation was installed with horizontal joints offset between adjacent layers, and no vertical joints. The furring strips used for this testing were nominal 1 × 3 SPF. The screws were installed at 16-in. o.c. with dimension priority given to the bottom of the furring strip. The top screw was placed 1 in. below the top of the furring strip. A ratchet setting was used to ensure uniform compression forces along the furring strips, and the setting was noted in the test spreadsheet. The two furring strips were offset 9/16 in. below the insulation to avoid movement of the loading steel angle.

C.3 Measuring Devices

Using magnetic bases, 2¼-in. deflection gauges were installed on a steel bar attached to the concrete block wall. Two metal clips were installed near the bottom of each furring strip; these were installed for the gauge readings. Two gauges were used to measure the deflection of the left and right furring strips; the third measured the displacement of the OSB. Note that any rotational deflection of the furring strips may influence the dial gauge reading.

C.4 Loading Mechanism

The loading mechanism used was a hydraulic jack rated to 4,000 lb. A 1,000-lb load cell was connected to the top of the hydraulic jack; the load cell was connected to a digital reader to convert voltage into mass readings. A 2.5 × 2.5 steel angle was used to transfer the load to the two furring strips. To avoid the steel angle hitting the wall, the furring strips were installed 0.5 in. below the bottom of the supporting wall.

C.5 Testing Procedure

The following procedure assumes that the framing, sheathing, and sheathing membrane have already been installed:

Install the support shelf using the ½-in. plywood spacers. The plywood spacers ensure that the insulation is installed flush with the bottom of the framed test wall, and that the furring strips are installed ½ in. below the edge of the insulation. Align the furring strips with the framing and install one screw near the bottom. Align the top of the furring strip with the stud marking at the top of the test wall, and finish installing the screws into the furring strip from the bottom to the top, inserting the insulation between the sheathing membrane and furring strip as required.

Install the angle using two small wood screws to hold it in place temporarily. Ensure that the angle is spaced evenly between the two furring strips, so that the push point for the hydraulic ram is equidistant from each furring strip. Install the dial gauges and ensure that they are all vertical. Install the two angles used as measurement points for the dial gauges near the bottom of each furring strip, and ensure that they are level. Place the hydraulic jack in the center and ensure that it is vertical. There is a concave point on the metal angle in which the end of the hydraulic ram rests.

Apply a small load to the hydraulic ram (~40 lb) and remove the screws that were used to temporarily hold the metal angle in place. Previous testing showed that keeping this metal angle screwed in place did affect the readings.

The amount of load applied to the furring strips is dependent on the test method. For the first series of Building America short-term deflection tests, some hysteresis analysis was conducted by applying various loads, and then releasing the load. If hysteresis measurements are taken, the hydraulic ram should only be unloaded to approximately 20 lb ($<1 \text{ lb/ft}^2$) so that the metal angle does not fall off the ram.

For the original set of 4-in. Building America short-term deflection testing, the testing protocol was as follows:

1. Load wall to 120 lb (4 lb/ft^2)
2. Unload wall to ~20 lb
3. Load wall to 360 lb (11 lb/ft^2)
4. Unload wall to ~20 lb
5. Load wall to 500 lb (16 lb/ft^2)
6. Unload wall to ~20 lb
7. Load wall to 750 lb (23 lb/ft^2)
8. Unload wall to ~20 lb
9. Load wall to 1,000 lb (31 lb/ft^2)

To unload the wall, especially at high loads, unscrew the release valve very slowly because the load will drop very quickly. Make any notes as required in the Excel template for data collection and analysis.

Appendix D: Long-Term Deflection Test Protocol

D.1 Support Structure

A wood framed wall was constructed and anchored to the CMU wall with metal brackets on the side and top to minimize movement of the framed wall relative to the CMU wall during testing. The wood framed wall was used to support the insulation and strapping for testing. The support frame consisted of a single 2 × 6 stud with a single top and bottom plate. Sixteen-inch-wide standard OSB sheathing was screwed into the frame. Plastic house wrap was installed to accurately represent the majority of enclosure wall systems in the field.

D.2 Insulation and Furring Strips

The insulation was installed in two layers of 2 in. (16-in. wide). The insulation was installed with horizontal joints offset between adjacent layers, and no vertical joints. A single 1 × 3 furring strip was installed in the center of the insulation. The furring strips used for this testing were nominal 1 × 3 SPF. The screws were installed at 16-in. o.c. with dimension priority given to the bottom of the furring strip. The top screw was placed 1 in. below the top of the furring strip.

D.3 Measuring Devices

A reinforced metal angle was attached to the back of the OSB so that the horizontal leg of the angle extended past the front surface of the insulation. A deflection gauge was attached to a wood block securely fastened to the bottom of the strapping so that the needle on the deflection gauge rested on the metal horizontal leg of the metal angle. As the strapping deflected, the metal angle remained stationary relative to the OSB sheathing, and the deflection of the strapping relative to the OSB was measured.

D.4 Loading Mechanism

For the long-term testing, weight was hung from a bracket securely fastened to the outside surface of the strapping so that the load is carried in the same position as it would be if cladding were attached to the strapping. To simulate cladding weight, buckets were three-quarters filled with concrete. The remainder of each bucket was filled with gravel so that the total added weight was approximately 213 lb (20 lb/ft²). These buckets were attached to the bracket with chain, and then slowly lowered to a hanging position using a hydraulic automotive jack.

Four of the test walls were loaded to 20 psf, and a fifth comparison wall was loaded to 50 psf.

D.5 Testing Procedure

The first reading was taken at the 30-s mark, which captured the immediate initial deflection once the weight was added. Several more readings were recorded during the first day to capture any deflection curve, should one exist, and then daily readings were taken Monday through Friday until the testing was complete.

buildingamerica.gov

U.S. DEPARTMENT OF
ENERGY | Energy Efficiency &
Renewable Energy

DOE/GO-102013-3571 • January 2013

Printed with a renewable-source ink on paper containing at least 50% wastepaper, including 10% post-consumer waste.