

Measure Guideline: Combination Forced-Air Space and Tankless Domestic Hot Water Heating Systems

Building America Report - 1206

30 August 2012

Armin Rudd

Abstract:

This guideline pertains to design and application guidance for combination space and tankless domestic hot water (DHW) heating systems (combination systems) used in residential buildings, based on field evaluation, testing, and industry meetings. As residential building enclosure improvements continue to drive heating loads down, using the same water heating equipment for both space heating and domestic water heating becomes attractive from an initial cost and space-saving perspective. This topic is applicable to single- and multifamily residential buildings, both new and retrofitted. Before committing to wide-scale implementation of such combination space and domestic water heating systems for high performance buildings, whether new or retrofit, design decisions and site conditions affecting performance, maintenance, and occupant acceptability should be well understood. Current performance rating procedures for this type of hot water heating system and its many variants are inadequate to provide convincing prediction of estimated savings. In order to be assured of meeting the Building America savings goals, and the persistence of those savings after installation, continued sharing of lab and field testing results is needed.

Measure Guideline: Combination Forced-Air Space and Tankless Domestic Hot Water Heating Systems

Armin Rudd
Building Science Corporation (BSC)

August 2012

NOTICE

This report was prepared as an account of work sponsored by an agency of the United States government. Neither the United States government nor any agency thereof, nor any of their employees, subcontractors, or affiliated partners makes any warranty, express or implied, or assumes any legal liability or responsibility for the accuracy, completeness, or usefulness of any information, apparatus, product, or process disclosed, or represents that its use would not infringe privately owned rights. Reference herein to any specific commercial product, process, or service by trade name, trademark, manufacturer, or otherwise does not necessarily constitute or imply its endorsement, recommendation, or favoring by the United States government or any agency thereof. The views and opinions of authors expressed herein do not necessarily state or reflect those of the United States government or any agency thereof.

Available electronically at <http://www.osti.gov/bridge>

Available for a processing fee to U.S. Department of Energy
and its contractors, in paper, from:

U.S. Department of Energy
Office of Scientific and Technical Information
P.O. Box 62
Oak Ridge, TN 37831-0062
phone: 865.576.8401
fax: 865.576.5728
email: <mailto:reports@adonis.osti.gov>

Available for sale to the public, in paper, from:

U.S. Department of Commerce
National Technical Information Service
5285 Port Royal Road
Springfield, VA 22161
phone: 800.553.6847
fax: 703.605.6900
email: orders@ntis.fedworld.gov
online ordering: <http://www.ntis.gov/ordering.htm>



Printed on paper containing at least 50% wastepaper, including 20% postconsumer waste

Measure Guideline: Combination Forced-Air Space and Tankless Domestic Hot Water Heating Systems

Prepared for:

Building America

Building Technologies Program

Office of Energy Efficiency and Renewable Energy

U.S. Department of Energy

Prepared by:

Armin Rudd

Building Science Corporation Industry Team

30 Forest Street

Somerville, MA 02143

NREL Technical Monitor: Cheryn Engebrecht
Prepared under Subcontract No. KNDJ-0-40337-00

August 2012

[This page left blank]

Contents

List of Figures	vi
List of Tables	vii
Definitions.....	viii
Executive Summary	ix
1 Introduction.....	1
2 Home and/or Document Inspection.....	1
3 Tradeoffs	2
3.1 Measure Selection Criteria.....	2
3.2 System Interaction	4
3.3 Cost and Performance Tradeoffs.....	4
4 Measure Implementation Details.....	8
4.1 Field Inspection	8
4.2 Install Procedure	8
4.2.1 System Design Strategies.....	8
4.2.2 Maintenance Issues and Practical Plumbing Perspectives	16
4.3 Verification Procedures and Tests	21
4.3.1 Laboratory and Field Test Performance	22
4.3.2 Rating Standards	27
4.3.3 Gaps and Barriers to efficient wide scale implementation	27
References	30

List of Figures

Figure 1. Photo of two installed combination space and domestic water heating systems with a condensing TWH and small storage tank	3
Figure 2. Schematic of installed combination space and domestic water heating system with a small storage tank	9
Figure 3. Schematic of installed combination space and domestic water heating system without a small storage tank	10
Figure 4. Combination space and tankless domestic water heating system with small insulated storage tank; heating supply air temperatures are mostly in the expected range for comfort (100°F - 115°F).....	11
Figure 5. Combination space and tankless domestic water heating system without storage tank; heating supply air temperatures are often outside of expectations for comfort.....	12
Figure 6. DHW consumption for combination systems with and without a storage tank.....	13
Figure 7. For combination system without storage tank, the DHW supply temperatures were often outside of expectations (i.e. < 104 °F typical for shower)	14
Figure 8. For combination system with storage tank, the DHW supply temperatures met expectations (i.e. > 104 °F typical for shower).	15
Figure 9. Four-year old decaying aluminum anode rod produces strainer-clogging material	16
Figure 10(a). Mineral precipitate removed from clogged inlet strainer	17
Figure 10(b). Dried mineral precipitate from inlet strainer – mostly calcium carbonate.....	17
Figure 10(c). Strainer-clogging debris that broke loose within the existing water pipes; new water heater supply pipes should be used when possible	18
Figure 11. Large pre-strainer installed to extend the water heater inlet strainer service interval to annual cleaning at most.....	18
Figure 12(a). Scale forming in a galvanized dielectric union fitting; all galvanized fittings should be plastic lined to reduce scale buildup	20
Figure 12(b). Scale being removed from a galvanized dielectric union fitting weeks after installation of an electronic water conditioner; the electronic water conditioner apparently loosens calcium carbonate particles and makes them electro-chemically less “sticky” so that they flow through the system.....	21
Figure 13. One second measured data from a combination system without a storage tank, showing a ten minute period with frequent low-flow on-off DHW draws without the water heater ever firing.....	22
Figure 14. The combination system without storage had a cycle rate nearly 10 times that of the combination system with storage.....	23
Figure 15. The combination systems ran about the same total number of hours per day, with or without storage	23
Figure 16. Electrical consumption and runtime for the hydronic air handler unit.....	24
Figure 17. Combined electrical consumption and runtime for the Rinnai condensing TWH and the Taco 013 circulator	24
Figure 18. The combination system did not respond to a DHW demand as evidenced by no inflection of the water temperature leaving the mixing valve (the slow drift was due to conduction); note that the water heater return temperature (from the heating loop) remained in the condensing region (<120°F).....	25

Unless otherwise noted, all figures were created by BSC.

List of Tables

Table 1. Initial cost comparison of a condensing furnace heating system with combination systems using the condensing tankless water heater, both with and without a separate small storage/buffer tank 6

Unless otherwise noted, all tables were created by BSC.

Definitions

ACEEE	American Council for an Energy Efficient Economy
ASHRAE	American Society of Heating, Refrigeration, and Air Conditioning Engineers
BA	Building America
BEopt	Building Energy Optimization software
Building Science Consortium	A team made up of Building Science Corporation personnel and project participants from private industry
BSC	Building Science Corporation
CEE	Center for Energy and Environment
CSA	Canadian Standards Association
combination system	combination space and domestic hot water heating system
DHW	domestic hot water
EnergyGauge	Energy and Economic Analysis software
NRC	Natural Resources Canada
NYSERDA	New York State Energy Research and Development Authority
USDOE	United States Department of Energy
USEPA	United States Environmental Protection Agency
SWH	storage water heater
TWH	tankless water heater

Executive Summary

This guideline pertains to design and application guidance for combination space and tankless domestic hot water (DHW) heating systems (combination systems) used in residential buildings, based on field evaluation, testing, and industry meetings. As residential building enclosure improvements continue to drive heating loads down, using the same water heating equipment for both space heating and domestic water heating becomes attractive from an initial cost and space-saving perspective. This topic is applicable to single- and multifamily residential buildings, both new and retrofitted. Before committing to wide-scale implementation of such combination space and domestic water heating systems for high performance buildings, whether new or retrofit, design decisions and site conditions affecting performance, maintenance, and occupant acceptability should be well understood. Current performance rating procedures for this type of hot water heating system and its many variants are inadequate to provide convincing prediction of estimated savings. In order to be assured of meeting the Building America savings goals, and the persistence of those savings after installation, continued sharing of lab and field testing results is needed.

The primary intended audiences for this guideline are: plumbing and heating designers and contractors, weatherization and building efficiency retrofit program managers, new construction building efficiency program managers, water heating equipment manufacturers, building research program managers, and energy policy and advisory staff.

As Building America builder partners choose to employ gas-fired, tankless domestic water heaters (both non-condensing and condensing) in order to achieve higher overall building energy efficiency, the strategy of combination space and domestic water heating systems appears attractive. The advantages are the relatively high water heating efficiency, the high heating capacity of gas-fired tankless water heaters (TWH), the compact space-saving size, and the initial cost advantage of using an existing high efficiency water heater in combination with additional components to simultaneously provide domestic water heating and space heating.

However, these tankless water heating systems are not without important potential drawbacks, including not being able to provide consistent temperature hot water during low-flow draws and frequent intermittent (on/off) draws. Addition of a small storage tank overcomes these drawbacks compared to a reference system without a small tank, however, proper insulation of all system and distribution components is critical. There may also be efficiency shortcomings whereby tankless heaters rated for condensing may not operate as condensing units due to high return water temperature. Maintenance issues related to pipe and heat exchanger scaling, and water heater inlet strainer clogging are additional risks to evaluate. Different water heating technologies are used in gas-fired TWHs. Some manufacturers use what is called “flash heating,” which heats only some of the water very hot, which may tend to generate more strainer-clogging mineral precipitate than non-flash heating units.

From a performance point of view, combination systems utilizing TWHs are of particular interest because of the high heating capacity and low standby losses. However, consistency of supplied water temperature at low flow rates and during rapid on/off usage patterns is a concern. Storage-type water heaters reduce or eliminate those concerns, but have relatively high standby losses.

Adding a small, external, well insulated storage volume to TWH combination systems provides a high value solution. Tankless water heaters also have more complex designs and water heating strategies that can impact efficiency at different flow rates and temperature differences. Intricate flow measuring and flow controlling components need to be protected from potential damage by foreign particles that may be in the water, but those protection filters can require unacceptable cleaning intervals. In order to achieve supply air temperatures of 105°F or greater, combination systems with a hydronic air handler generally require heating water at a higher temperature than required for DHW only (radiant floor hydronic systems do not). The hotter water is heated, the more potential there is for mineral scale and galvanic corrosion. All of these factors need to be considered and firm design recommendations made before wide implementation of these systems.

Combination space and DHW heating systems work best in houses with high-performance building enclosures and ducts inside conditioned space. This allows for better comfort at lower heating supply air temperatures, and for less conflict between DHW and space heating demands. In retrofit applications of combination systems, it is especially important to make sure that the existing air duct system is well insulated and air-sealed.

Combination systems may make the most sense in new construction since proper design of the total system is possible, including properly sized and insulated plumbing to avoid extended delay time in delivering water, and properly sized and sealed air ducts. In retrofit cases, the existing gas service line (either the outside utility line or in building) may not have adequate capacity to serve the high demand of a TWH or high capacity storage type water heater. In addition, retrofit venting may be more difficult, and old scaled pipes may worsen water flow or inlet filter clogging problems.

The rating performance standards for combination systems need to be expanded and improved to encompass the new equipment and designs both on approaching the market. That is also needed to better predict actual performance by testing and modeling more realistic use patterns and a wider range of inlet and outlet water temperatures, including for solar preheat to combination systems.

New factory-supplied total systems are needed to overcome mixed supplier conflicts. Improved design and control methodologies are needed to maximize combination system benefits. This includes predicting and achieving better consumer comfort and energy savings, for example, by providing stable water temperature throughout the range of common flow rates and use patterns, assuring consistent condensing operation, fully understanding the pros and cons of adding small storage volumes to combination systems using TWHs, and adding solar preheat to combination systems.

Acknowledgment

The author acknowledges the valuable participation of NYSERDA in providing access to, and support for, two combination space and tankless DHW heating systems (combination systems) for evaluation and monitoring..

1 Introduction

This guideline pertains to design and application guidance for combination space and tankless DHW heating systems (combination systems) used in residential buildings, based on field evaluation, testing, and industry meetings. As residential building enclosure improvements continue to drive heating loads down, using the same water heating equipment for both space heating and domestic water heating becomes attractive from an initial cost and space-saving perspective. This topic is applicable to single- and multi-family residential buildings, both new and retrofitted. Before committing to wide-scale implementation of such combination space and domestic water heating systems for high performance buildings, whether new or retrofit, design decisions and site conditions affecting performance, maintenance, and occupant acceptability should be well understood. Current performance rating procedures for this type of hot water heating system and its many variants are inadequate to provide convincing prediction of estimated savings. In order to be assured of meeting the Building America savings goals and the persistence of those savings after installation, continued sharing of lab and field testing results is needed.

The primary intended audiences for this document are: plumbing and heating designers and contractors, weatherization and building efficiency retrofit program managers, new construction building efficiency program managers, water heating equipment manufacturers, building research program managers, and energy policy and advisory staff.

This guideline is important to the building industry because the successful application of gas-fired TWHs has the potential to significantly reduce hot water heating energy use compared to standard power-vented water heaters. Combining these tankless water heating units in systems that also provide space heating may free up building funds to invest in other improvements that further contribute to the overall success of high-performance housing.

Overall, the goal of the U.S. Department of Energy's (DOE) Building America program is to “reduce home energy use by 30%-50% (compared to 2009 energy codes for new homes and pre-retrofit energy use for existing homes).” To this end, Building America teams conduct research to “develop market-ready energy solutions that improve efficiency of new and existing homes in each U.S. climate zone, while increasing comfort, safety, and durability.”¹

2 Home and/or Document Inspection

As Building America builder partners choose to employ gas-fired, tankless domestic water heaters (both non-condensing and condensing) in order to achieve higher overall building energy efficiency, the strategy of combination space and domestic water heating systems appears attractive. The advantages are the relatively high water heating efficiency, high heating capacity of gas-fired TWHs, compact space-saving size, and the initial cost advantage of using an existing high efficiency water heater in combination with additional components to simultaneously provide domestic water heating and space heating.

¹ http://www1.eere.energy.gov/buildings/building_america/program_goals.html

However, these tankless water heating systems are not without important potential drawbacks, including being unable to provide consistent temperature hot water during low-flow draws and frequent intermittent (on/off) draws. Addition of a small storage tank overcomes these drawbacks compared to a reference system without a small tank, however, proper insulation of all system and distribution components is critical. There may also be efficiency shortcomings whereby tankless heaters rated for condensing may not operate as condensing units due to high return water temperature. Maintenance issues related to pipe and heat exchanger scaling, and water heater inlet strainer clogging are addition risks to evaluate. Different water heating technologies are used in gas-fired TWHs. Some use what is called “flash heating,” which heats only some of the water very hot, which may tend to generate more strainer-clogging mineral precipitate than non-flash heating units.

3 Tradeoffs

3.1 Measure Selection Criteria

The implementation of hundreds of combination space and DHW heating systems during the mid-1990s to early 2000s led to some lessons learned. These systems were primarily installed by production builder partners in the markets of Las Vegas, Albuquerque, and Houston. They employed ducted hydronic air handlers and storage-type, natural draft, natural gas-fired water heaters, where water heater input capacity was about 75 kBtu/h and the water storage capacity was in the range of 50 to 75 gallons. In isolated cases these were high output (100 kBtu/h), high efficiency (95% condensing combustion efficiency) units, but in most cases, these were standard to slightly higher input capacity and standard efficiency (EF=0.56 to 0.62) units. Those combination space and DHW heating systems worked well when the space heating load was less than about 35 kBtu/h, which is normal for most Building America projects.

Design issues were studied related to DHW priority control, control of intermittent flushing of the heating loop to avoid water stagnation in the off season, and design optimization of the storage capacity, the storage temperature and the heating output capacity. Few problems were experienced with these systems with one exception. In a small percentage of cases, a serious energy waste problem occurred whereby collection of debris under the integral check valve in the circulator caused a natural thermo-siphon flow that would send hot water through the space heating coil when space cooling was active. A stronger spring-loaded, more positive shut-off check valve or a powered solenoid valve could have eliminated that problem; however, other market forces were already at work to cause a move away from those systems. The price of high efficiency furnaces (93% to 95% AFUE) was falling and the furnaces were more readily available from a number of manufacturers.

From a performance point of view, combination systems using TWHs are of particular interest because of the high heating capacity and low standby losses. However, consistency of supplied water temperature at low flow rates and during rapid on/off usage patterns is a concern. Storage-type water heaters reduce or eliminate those concerns, but have relatively high standby losses. Adding a small, external, well insulated storage volume to TWH combination systems provides a high-value solution. Tankless water heaters also have more complex designs and water heating strategies that can impact efficiency at different flow rates and temperature differences. Intricate flow measuring and controlling components need to be protected from damage by foreign

particles in the water, but those protection filters can require unacceptable cleaning intervals. In order to achieve supply air temperatures of 105°F or greater, combination systems with a hydronic air handler generally require heating water at a higher temperature than required for DHW only (radiant floor hydronic systems do not). The hotter water is heated, the more potential there is for mineral scale and galvanic corrosion. All of these factors need to be considered and firm design recommendations made before wide implementation of these systems.

Two combination systems were evaluated as part of a NYSERDA deep energy retrofit project in Utica, New York. A photo of these systems is shown in Figure 1. The contractor for the two combination systems was selected by sealed bid. The bid for these installed systems was about \$3,500 per system, which was less than half of what the cost would have been for a boiler system replacement. The cost of the condensing water heater unit alone (EF=0.93) was about \$1,000, which is about twice as much as a power vented water heater with EF=0.62. Using the EnergyGauge USA program (FSEC 2010), domestic water heating savings were estimated to be about \$150/yr, for a 3- to 4-year simple payback. However, the total combination system equipment cost savings provides an immediate payback. Investing those equipment cost savings into enclosure improvements is estimated to save another \$200/year in space conditioning energy.



Figure 1. Photo of two installed combination space and domestic water heating systems with a condensing TWH and small storage tank

The space-saving compactness of the combination system with TWH is an attractive benefit where the mechanical equipment is preferably installed inside conditioned space. A potential drawback compared to a typical furnace and domestic water heater is the risk of being without both space heating and DHW at the same time if the combination system water heater fails and repair service is delayed.

Probably the most important trade-off on the risk side is the potential for greatly increased maintenance requirements due to clogging of the TWH inlet strainer and accumulation of calcium or lime scale in the heat exchanger and piping. The inlet strainer is designed to protect the modulating water valve and flow meter in the tankless heater. However, due to the constant source of new minerals when the system is open, and the circulation of hot water and mineral precipitate when the combination system is closed, additional pre-straining of the water just before it enters the TWH is important to avoid intolerable maintenance intervals.

3.2 System Interaction

Combination space and DHW heating systems work best in houses with high-performance building enclosures and ducts inside conditioned space. This allows for better comfort at lower heating supply air temperatures, and for less conflict between DHW and space heating demands. In retrofit applications of combination systems, it is especially important to make sure that the existing air duct system is well insulated and air-sealed.

3.3 Cost and Performance Tradeoffs

Although energy savings are expected, it is possible that overall hot water usage may increase due to the application of gas-fired TWH with “unlimited” supply of hot water. In addition, a natural reaction to insufficient or unstable hot water supply temperature may be to use a higher flow rate of hot water and/or to leave the hot water on for longer continuous periods. If these things occur, there may be some savings “take-back” tradeoffs to evaluate.

Data indicates that condensing TWH efficiency increases from about 87% at 130°F return water temperature to about 94% at 80°F return water temperature (Magande 2011). In order to maximize condensing operation, pump flow controls can be employed to control on return water temperature. In other words, if the return water temperature is too high to achieve efficient condensing operation, the pump flow could be automatically reduced. But that forces a trade-off with heating supply air temperature, since as the pump flow and the return water temperature drops, so does the supply air temperature and the hydronic air handler efficiency (meaning the ratio of heat output divided by the electrical energy input). Air source heat pumps often operate at supply air temperatures below 100°F, and geothermal heat pumps often operate at supply air temperatures around 105°F, and whole-house air circulation strategies effectively move room temperature air, so the supply air temperature problem can be managed. But, proper duct design, and appropriate supply grille design and placement is critical to avoid cool air complaints.

Larger hydronic coils can also be used to lower return water temperature without reducing pump flow or air handler efficiency, but that has an economic trade-off of higher equipment cost.

Testing from the Center for Energy and Environment (CEE) indicates that hydronic air handler coil sizes need to be much larger to achieve low enough return water temperature to provide consistently high condensing efficiency. The CEE data, averaged for a group of combination

systems with condensing water heaters, showed that total heating plant efficiency (gas and electric) was about 82% with 120°F return water temperature and about 91% with 80°F return water temperature.

The contractor installed cost for a NYSERDA combination system retrofit project was \$3,500 per system for two identical systems in a two-family house. Installed combination systems using a condensing TWH, with or without a small external insulated storage volume, can cost less than half the installed cost of traditional boiler and indirect water heater designs.

Contractor bids for a CEE project for a group of four different installed combination systems by two different contractors showed that costs varied from about \$6,000 to \$10,000 per system (Schoenbauer 2011).

Assuming an existing condensing TWH, Table 1 further illustrates an initial cost comparison of a traditional condensing gas furnace space heating system with combination systems using the condensing tankless water heater, both with and without a separate small storage/buffer tank (according to Figures 2 and 3, respectively). These costs were derived from trade price quotes. If there will already be a condensing TWH then:

- A TWH combination heating system with a buffer tank, as described here, costs about \$350 more than a condensing furnace heating system
- A TWH combination heating system without a buffer tank costs about \$400 less than a condensing furnace heating system

Table 1. Initial Cost Comparison of a Condensing Furnace System with Combination Systems Using the Condensing Tankless Water Heater

Condensing furnace system	Cost (\$)
95% furnace (Goodman)	1441
extra venting supplies+labor	250
extra gas hookup	200
	1891
Combination system with buffer tank	
Hydronic furnace (Rinnai AHB45)	1073
6-12 gal insulated tank	210
009-SF5, stainless steel circulator	330
thermostatic mixing valve	75
pre-strainer	150
extra plumbing supplies+labor	400
	2238
Combination system without buffer tank	
Hydronic furnace (Rinnai AHB45)	1073
pre-strainer	150
thermostatic mixing valve	75
extra plumbing supplies+labor	200
	1498

Based on studies done by Natural Resources Canada (NRC), using a *condensing* water heater for a combination system is necessary to achieve the same or better overall efficiency compared to a condensing furnace and a 0.62 EF water heater in cold climates (Thomas 2011).

Estimates of system initial cost comparisons show:

Lowest cost category:

- Hydronic air handler + condensing TWH combination system without small storage/buffer tank
- Hydronic air handler + condensing storage water heater combination system
- Condensing furnace and condensing tankless or storage water heater.

Middle cost category:

- Hydronic air handler + condensing TWH combination system with small storage/buffer tank.

Highest cost category:

- Hydronic air handler + condensing boiler combination system
- Hydronic air handler + condensing tankless or storage water heater combination system + solar preheat.

Some have postulated that it is difficult to justify investment on a cost basis for condensing water heating. However, the lower cost for venting a condensing unit (less expensive plastic) can cancel the higher cost of the condensing heater (Frizalone 2011).

Combination systems may make the most sense in new construction since proper design of the total system is possible, including properly sized and insulated plumbing to avoid extended delay time in delivering water, and properly sized and sealed air ducts. In retrofit cases, the existing gas service line (either the outside utility line or in building) may not have adequate capacity to serve the high demand of a TWH or high capacity storage type water heater. In addition, retrofit venting may be more difficult, and old scaled pipes may worsen water flow or inlet filter clogging problems.

Critical Takeaways

Tankless water heaters are high input units requiring gas service lines that are often larger than what is normally there for existing housing.

Adequate space and acceptable location needs to be available for short through-wall or through-roof direct venting.

As much as possible, insulate all hot water lines and air seal all air ducts.

Contractor education is important to stabilizing fair installation cost.

For combination system operating cost performance in cold climates to compare favorably against a condensing furnace and standard hot water heater, a condensing hot water heater must be used.

Contractor/Homeowner Safety

OSHA or other guidelines on lead paint and asbestos

[OSHA] U.S. Department of Labor, Occupational Safety & Health Administration (1999). OSHA Technical Manual, TED 01-00-015 [TED 1-0.15A]. Washington, DC: S. Department of Labor, Occupational Safety & Health Administration.

4 Measure Implementation Details

4.1 Field Inspection

Before retrofit application of TWH combination systems, a site evaluation should be made to determine whether the gas service supply line has sufficient capacity to serve the high-capacity heater, and to determine acceptable direct venting accessibility. Refer to the National Fuel Gas Code (NFPA 2012). Although not absolutely necessary, the ability to install a new water supply line to the water heater location should be evaluated because it may help avoid potential low-water-flow and strainer-clogging-debris problems (Figure 10(c)).

4.2 Installation Considerations

This section covers design strategies studied and installation considerations in view of field experience with installation and maintenance of combination systems.

4.2.1 System Design Strategies

Condensing combination heating systems are ideal for radiant floor heating applications because of the lower temperature water required (98°F – 120°F), the long cycle times, and simple controls. Domestic hot water priority control is not needed in combination systems used for radiant floor heating because it is inherent in the system, considering that the large pressure drop from mains pressure to open tap will take most of the flow compared to the pressure developed by a 2 gpm circulator typically used for this application.

The schematics of Figures 2 and 3 show the system design for the combination systems with and without a small storage tank, respectively.

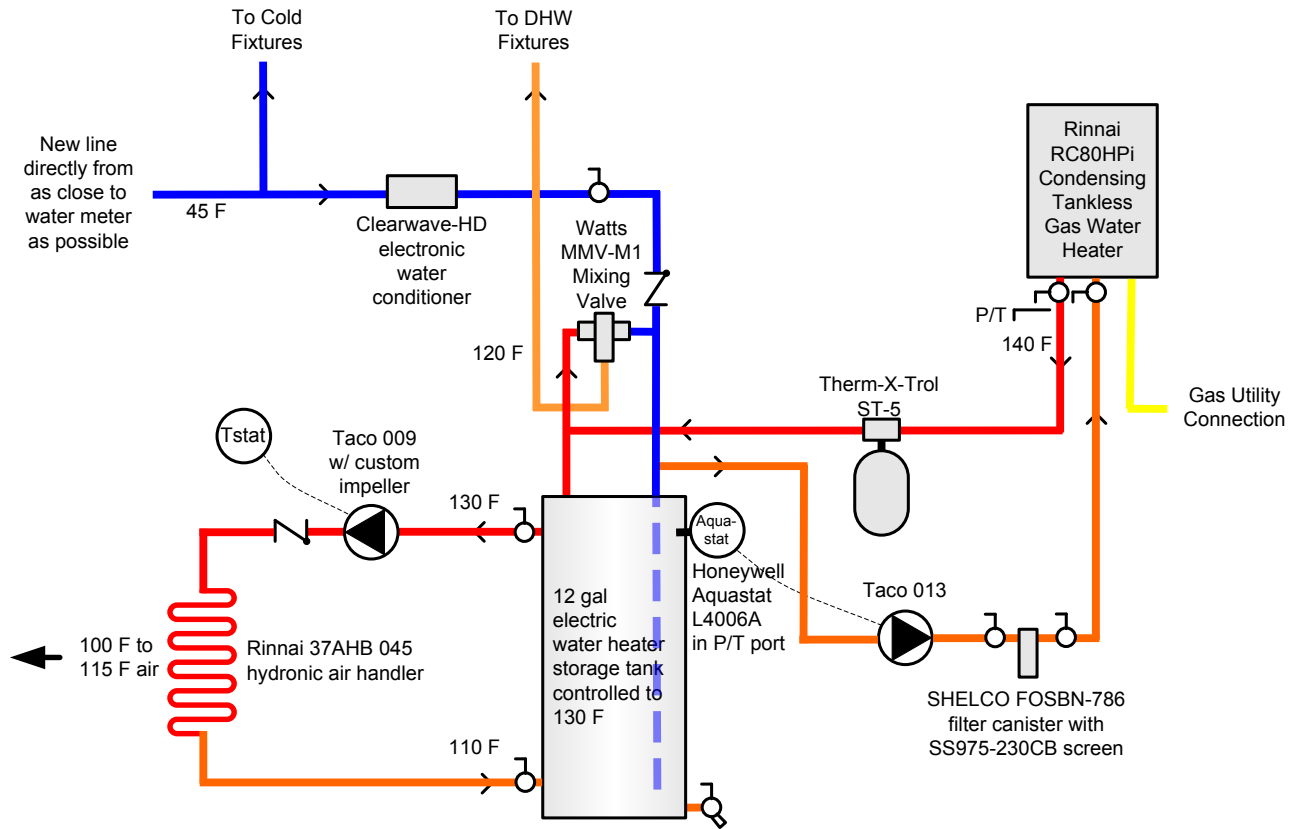

Figure 2. Schematic of installed combination space and domestic water heating system with a small storage tank

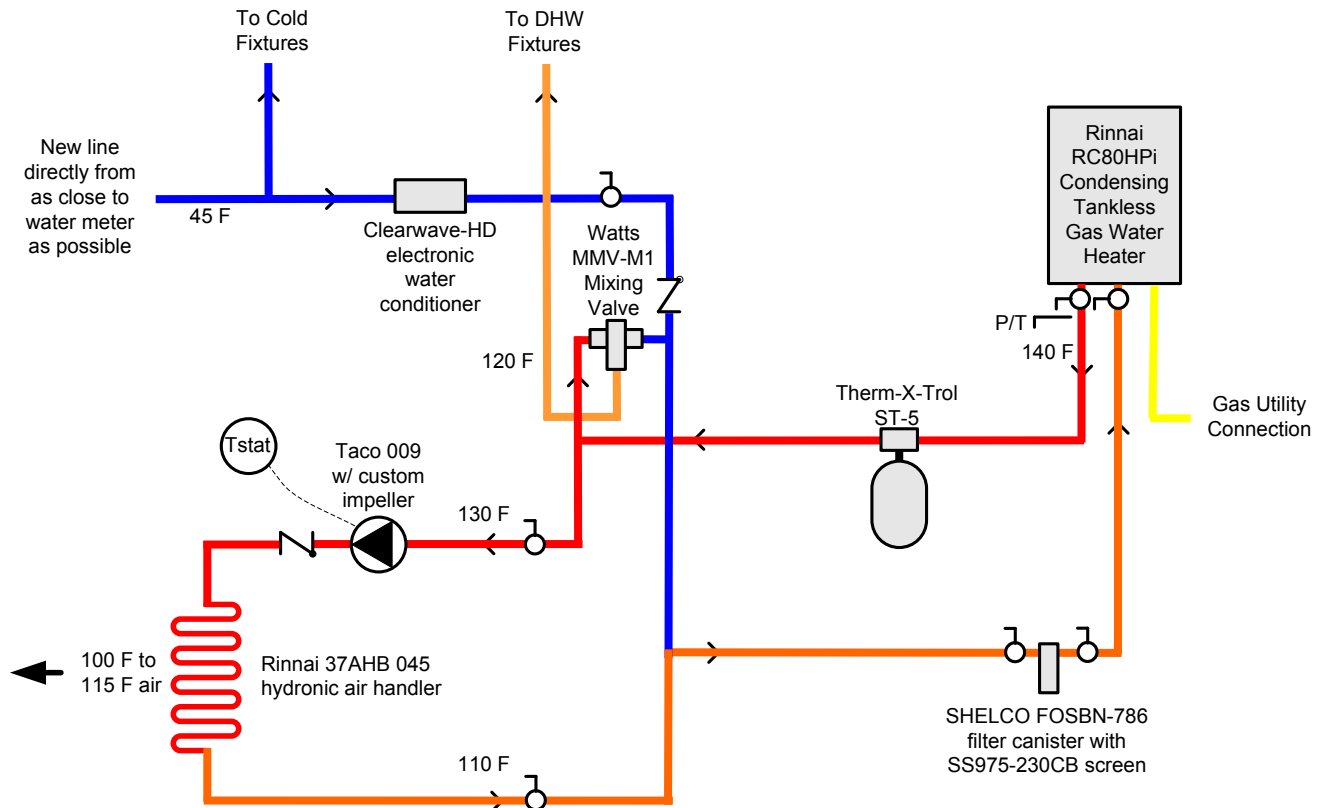

Figure 3. Schematic of installed combination space and domestic water heating system without a small storage tank

Circulator protection, also providing a form of DHW priority, may be necessary for hydronic air handler combination systems where the circulator in the hydronic space heating loop is above domestic water taps. These must have sufficient volume flow to at least partially drain the hydronic loop such that the circulator may not remain fully wetted.

Domestic hot water priority is necessary for TWH/hydronic air handler combination systems without storage to avoid delivery of heating supply air below 100°F. The objective is for heating supply air to be 100°F - 115°F. Figures 4 and 5 show measured examples of the heating supply air temperatures provided by TWH/hydronic air handler combination systems with and without storage, respectively. With storage, the supply air temperature is generally in the expected range; without storage it is not.

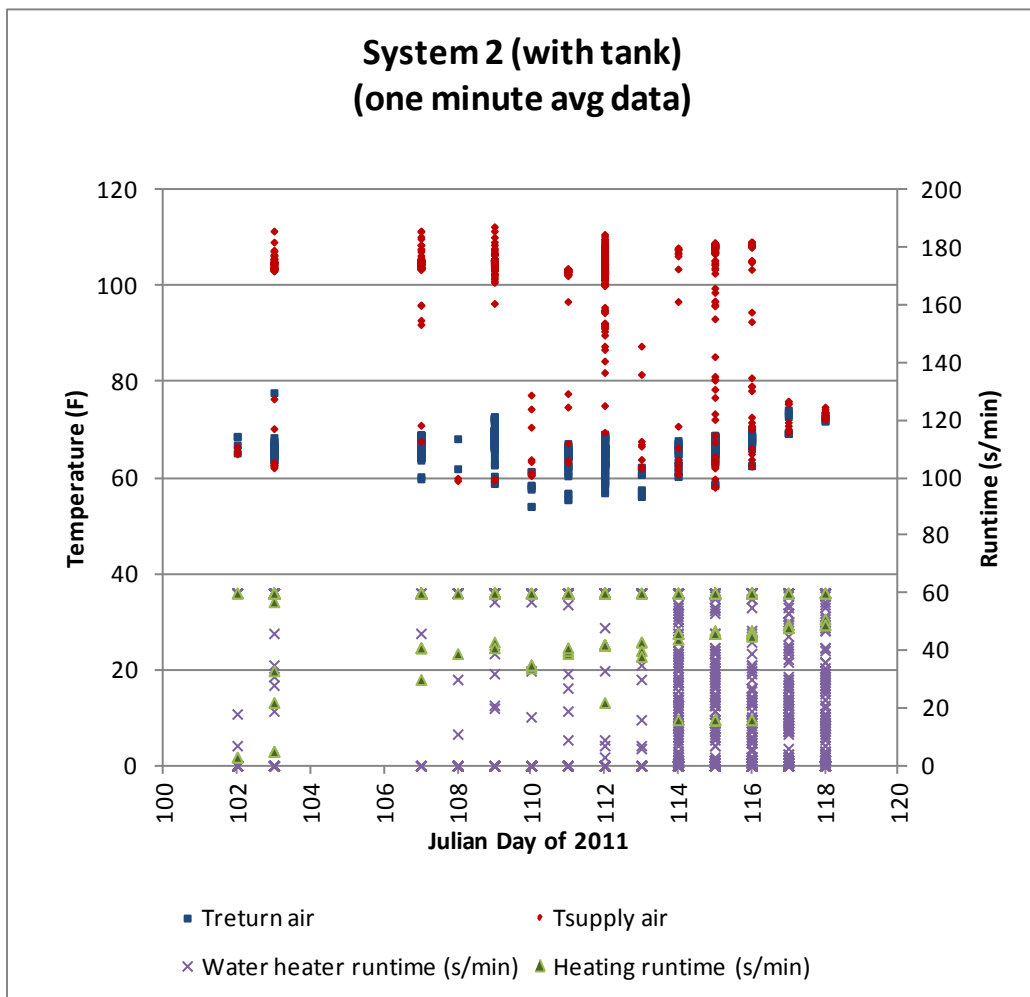

Figure 4. Combination space and tankless domestic water heating system with small insulated storage tank; heating supply air temperatures are mostly in the expected range for comfort (100°F - 115°F)

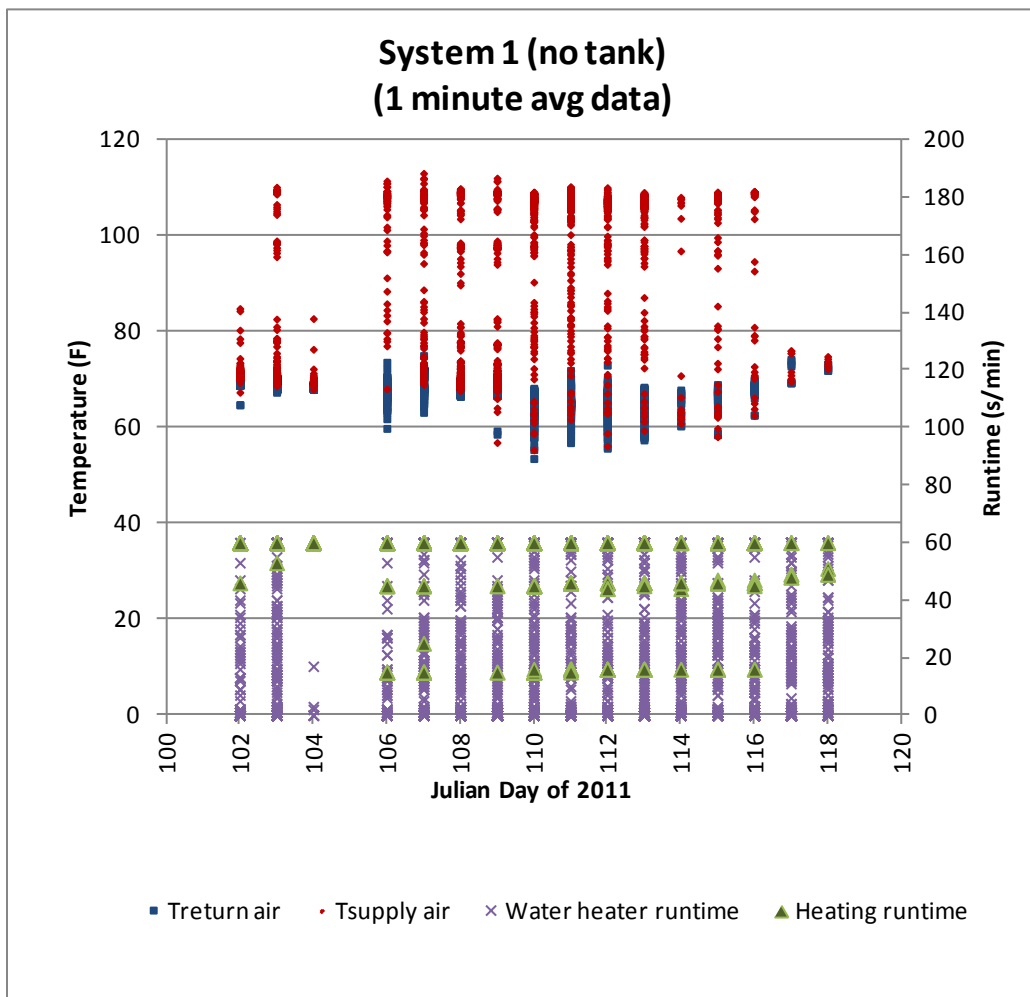

Figure 5. Combination space and tankless domestic water heating system without storage tank; heating supply air temperatures are often outside of expectations for comfort

In cases where the circulator will not always be flooded—such as when the circulator is above the domestic water taps and there is no storage tank to circulate water to and from—DHW priority is also needed to avoid problems with the heating circulator running without a full pipe of water. Some units shut off the heating circulator when an inline flow sensor senses less than 1 gpm in that loop.

Figure 6 shows a snapshot of measured DHW usage for two dwellings with combination systems using TWH. System 1 serves the first floor of the two-family building and does not have a storage tank, while System 2 serves the second floor and does have a small storage tank. The number of occupants generally averages four in both cases. Occupants in the unit without the storage tank complain of having to wait a long time for the water to get hot, while the occupants with System 2 say they are satisfied with the hot water supply performance. From a cold start, the System 1 hot water wait time (just over 1 minute) is twice that of System 2.

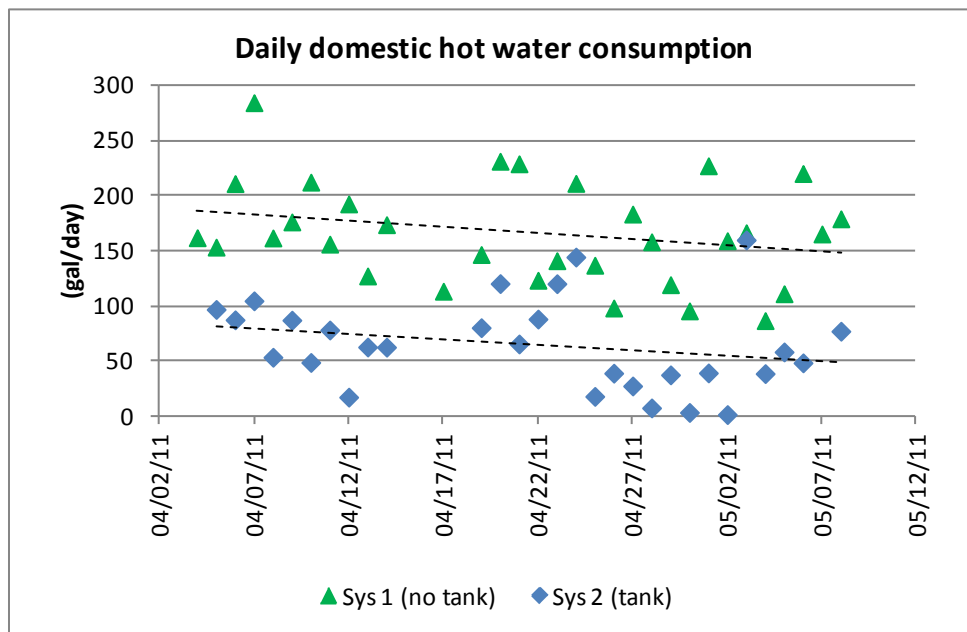

Figure 6. DHW consumption for combination systems with and without a storage tank

Some designers/installers want to avoid installing a mixing valve by keeping the TWH set-point temperature at 120°F. Testing showed that heating the water hotter than needed for DHW, then using a mixing valve to reduce the supplied water temperature, gives the best performance. That avoids large upswings and drops in water temperature at a shower when heating is activated and deactivated (Magande 2011). In a system without a mixing valve, with the TWH set-point at 120°F, and the shower adjusted to 105°F, there was a 4°F upswing at the shower when heating was activated, and a 6°F droop when heating was deactivated. With a pressure balancing mixing valve set at 120°F, the water heater set-point temperature at 140°F, and the addition of a small inline buffer volume (1.5 inch diameter by 12 inch long pipe, or 1.5 cup) there is no significant change in delivered water temperature at a 105°F shower at the beginning or end of a heating call. Assuming 50 ft of 3/4" pipe (about 1 gallon) in the piping from the hot water heater to the shower, the 1.5 cup buffer volume doesn't change the roughly 1-minute wait time to get hot water to the shower from a cold start. The buffer device needs to be well insulated to avoid efficiency loss (Rubatex or Armaflex type insulation wall thickness at least half the pipe diameter). Supplying 140°F water to the hydronic air handler yielded a 118°F supply air temperature and about 105°F return water temperature. Ongoing testing may allow further optimization for condensing efficiency, i.e., moving the TWH set-point temperature down with the goal of 100° F return water temperature.

A resonant-frequency-type humming noise may be noticed with some tankless hot water heater installations. This can be a symptom of TWH exhaust air recirculating back to the unit with the incoming combustion air. In this case, a cold climate kit (long-nose snout) may be needed to obtain more separation between the two air streams.

When TWHs were first introduced in the United States, the water flow rate threshold for heater activation was about 0.7 gpm or higher. The industry quickly raised concerns about the unavailability of hot water at commonly lower flow rates. Figure 7 shows that DHW draws are often in the range of 0.7 gpm, and that without a small storage tank, there is a significant problem with hot water supply. Figure 8 shows that with a small storage tank, DHW supply is generally good. Manufacturers have been responding to low-flow concerns by lowering the activation threshold, which is now as low as 0.4 gpm, and some units can continue to operate as low as 0.26 gpm after it has already been activated at the higher threshold.

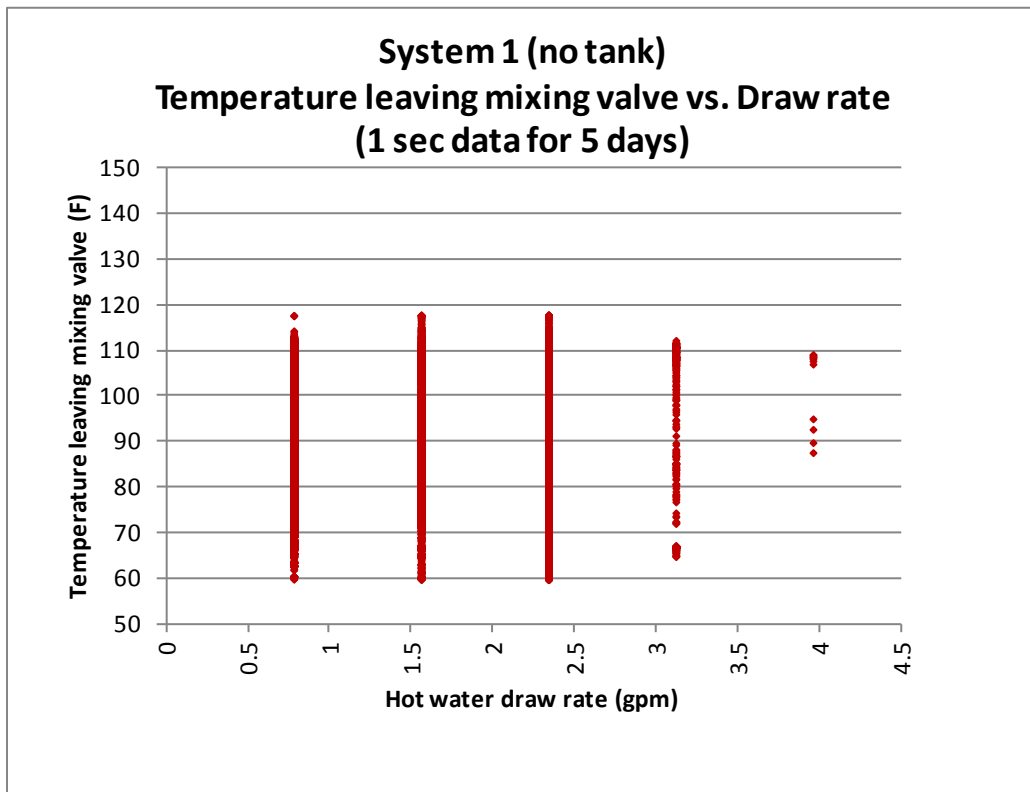

Figure 7. For combination system without storage tank, the DHW supply temperatures were often outside of expectations (i.e. < 104 °F typical for shower)

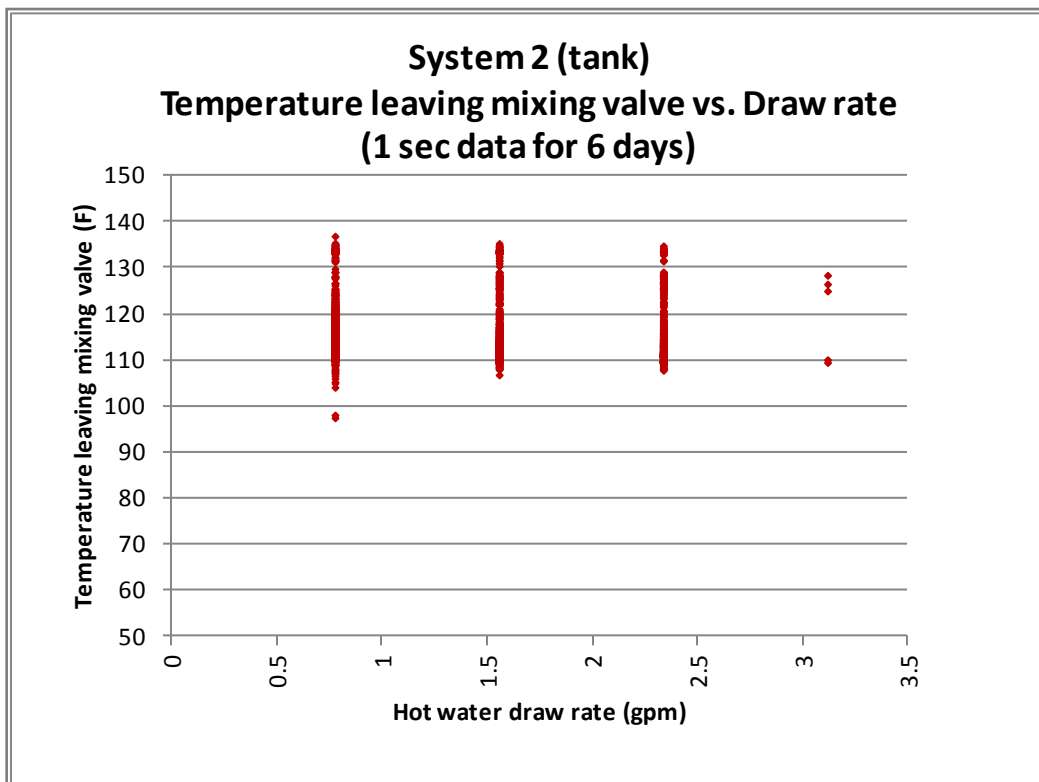

Figure 8. For combination system with storage tank, the DHW supply temperatures met expectations (i.e. > 104 °F typical for shower).

Manufacturers acknowledge problems associated with maintaining consistent hot water supply temperature with TWHs due to hot/cold plug flow and trickle flow (less than activation flow). Designs are recommended that include additional stored water volume to overcome that issue. Some of those designs are described as unpowered (passive tank) and powered (active tank) options. The powered tank option is the most robust in solving the problem but requires more electrical energy to offset tank heat losses. The unpowered option increases hot water delivery time due to the larger volume of cooled-off water when there has not been DHW or heating demand for some time.

High capacity storage type water heaters used in combination systems eliminate the cold water sandwich and trickle flow problems associated with TWHs, but high jacket heat loss and long runtimes to reach condensing operation reduce efficiency. A condensing storage type water heater starts condensing after about 10 to 15 minutes of operation, while a condensing TWH starts condensing operation almost immediately due to cool incoming water cooling the combustion exhaust (Shoenbauer 2011). Condensing operation for both heaters is dependent upon: (a) incoming water temperature, (b) thermal 'state' of stored water/heat exchanger, (c) draw rate, (d) excess combustion air (or alternatively flue gas dew point), and (e) heat exchanger design. Under the right circumstances, for example, during a high volume draw with cold incoming temperature and operating with low excess combustion air, condensing storage water heaters can condense within 60 seconds, even less if the stored water is cold. Conversely, under the right circumstances, for example, having a low flow draw on a TWH with high excess air and a high incoming water temperature, condensing may not even occur at steady state.

4.2.2 Maintenance Issues and Practical Plumbing Perspectives

Traditionally, TWHs have been mostly used in open systems for DHW heating only. Any time you cause any type of closed system recirculation, such as when water is circulated to keep hot water more quickly available at the taps, or such as when water is circulated for space heating, anything generated inside the system (e.g., anode rod decay, shown in Figure 9 or mineral precipitate, as shown in Figures 10(a) and 10(b)), will end up clogging the inlet strainer designed to protect flow measuring and flow controlling components. Field experience has shown that the inlet strainer cleaning interval can be anywhere from days to months without a large pre-strainer, and extended to annual service with a large pre-strainer. The pre-strainer used in BSC projects has a 200-micron stainless steel screen (Figure 11), compared to the 238-micron screen in the Rinnai tankless heater's inlet strainer. Bosch uses a 300-micron inlet strainer.

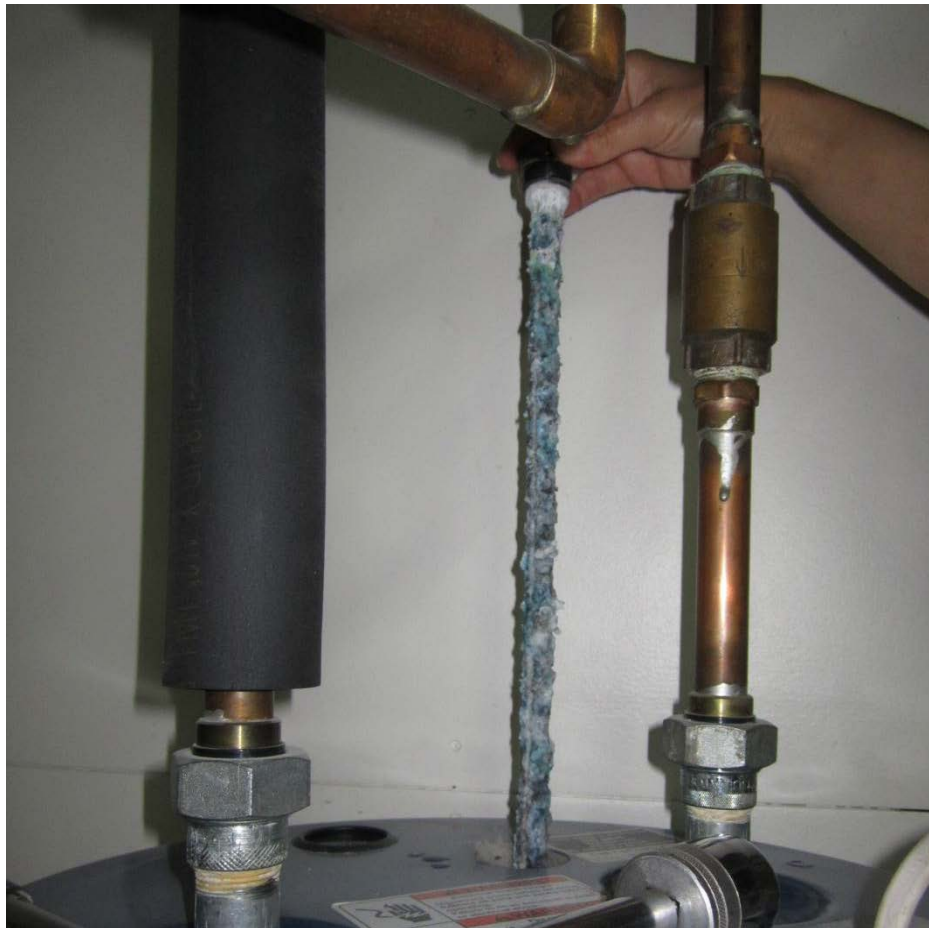

Figure 9. Four-year old decaying aluminum anode rod produces strainer-clogging material



Figure 10(a). Mineral precipitate removed from clogged inlet strainer



Figure 10(b). Dried mineral precipitate from inlet strainer – mostly calcium carbonate



Figure 10(c). Strainer-clogging debris that broke loose within the existing water pipes; new water heater supply pipes should be used when possible



Figure 11. Large pre-strainer installed to extend the water heater inlet strainer service interval to annual cleaning at most

Some TWHs use a heating method sometimes referred to as “flash” heating. That control strategy sends only a portion of the total water flowing through the unit through the heat exchanger, the rest is bypassed and re-mixed at the unit outlet. The portion going through the heat exchanger is heated to an elevated temperature 150°F to 185°F. This is done to prevent condensation and corrosion in a non-condensing heat exchanger when heating water to less than 120°F. Generally, the heat exchanger temperature should be kept above at least 125°F to avoid condensation, so, using the flash heating strategy, the lower the requested set-point temperature, the more the overheating. It is known that the hotter water is heated, the more mineral precipitate (mainly calcium carbonate) will drop out of solution. This will contribute to scale formation, and contributes to clogging of the water heater’s inlet strainer screen whenever recirculation is active.

Navien’s TWHs do not use the flash heating method. All of the water flowing through their units flows through a stainless steel heat exchanger, which better resists corrosion and water abrasion, and the water is heated only as much as needed to reach the output set-point without post-mixing. This may be an important factor in extending inlet strainer cleaning intervals.

Bosch believes that the inlet strainer on their equipment can be removed after the first week or so of operation after installation or after any new plumbing is done. The basis for this is that, in their experience, the potentially damaging foreign material in the system is generally bits of copper, thread tape, and thread sealant from the piping installation, and after that material is captured and removed, the strainer is no longer needed. It may be that other manufacturers are being too conservative with either the micron size of the inlet strainer, or in requiring the continued use of the strainer at all. If that is so, then perhaps the only problem that BSC has experienced with these combination systems to date—that of clogged inlet strainers—could be easily resolved. Although a smaller Y strainer may be adequate in some cases, BSC has resorted to adding a large-capacity, stainless steel strainer ahead of the TWH filter screen. However, this adds about \$150 material cost, another 1/3 gallon storage to the system, and another fixture to insulate.

It is unlikely that a combination system would increase the risk of pipe scaling over that of a TWH system alone; however, because of the recirculation involved, BSC has found inlet filter clogging to be a serious problem that must be addressed upfront in the design.

BSC found that an electronic water conditioner can remove existing calcium carbonate scale in piping and prevent new scale from forming (Figures 12(a) and 12(b)). Rinnai TWHs sense when scale is affecting efficiency by more than 5% and display a fault condition if this occurs. The Rinnai non-condensing TWH combination system where BSC applied the electronic water conditioner has gone through four years without a scale fault condition. Excess scale can cause a condensing TWH to be non-condensing.



Figure 12(a). Scale forming in a galvanized dielectric union fitting; all galvanized fittings should be plastic lined to reduce scale buildup



Figure 12(b). Scale being removed from a galvanized dielectric union fitting weeks after installation of an electronic water conditioner; the electronic water conditioner apparently loosens calcium carbonate particles and makes them electro-chemically less “sticky” so that they flow through the system

According to Rinnai, a set-point temperature of 140°F is a “sweet spot” for the Rinnai system efficiency and delivered temperature consistency. Especially with the hotter water temperature common with combination systems, it is important to use plastic-lined galvanized nipples for connecting to a steel tank. Unlined nipples will scale quickly, reducing and sometimes blocking off water flow. Scale can also break loose and contribute to clogging the TWH inlet strainer. In an attempt to deal with problematic hard water issues, some people over-soften the water which removes a useful thin protective layer of scale formation in copper pipes, and hastens thinning of the relatively soft metal by water erosion. Hot water recirculation systems also wear out copper pipes and TWHs. It is far better to use good piping design and pipe insulation to reduce hot water delivery wait times.

4.3 Testing Rating, and Implementation

This section covers a limited set of performance testing as it relates to effective operation of combination space and domestic water heating using a TWH, an overview of rating standards used to assess or predict the performance of combination systems, and remaining gaps and barriers to wide-scale implementation of combination systems.

4.3.1 Field Test Performance

Frequent brief demands for DHW when using TWHs can lead to customer dissatisfaction issues due to lack of hot water. The water heater may not fire at all, or short-cycle such that it may not run long enough to produce hot water. Short cycling may be defined as runtimes less than 10 seconds. Many DHW draws are for less than 10 seconds and it is questionable whether any useable energy is delivered in that case. Figure 13 shows a 10-minute occupied period with frequent on-off DHW demand cycles, but the hot water heater never fired as evidenced by the unchanging water temperature leaving the mixing valve. Equipment rating standards do not require testing for that.

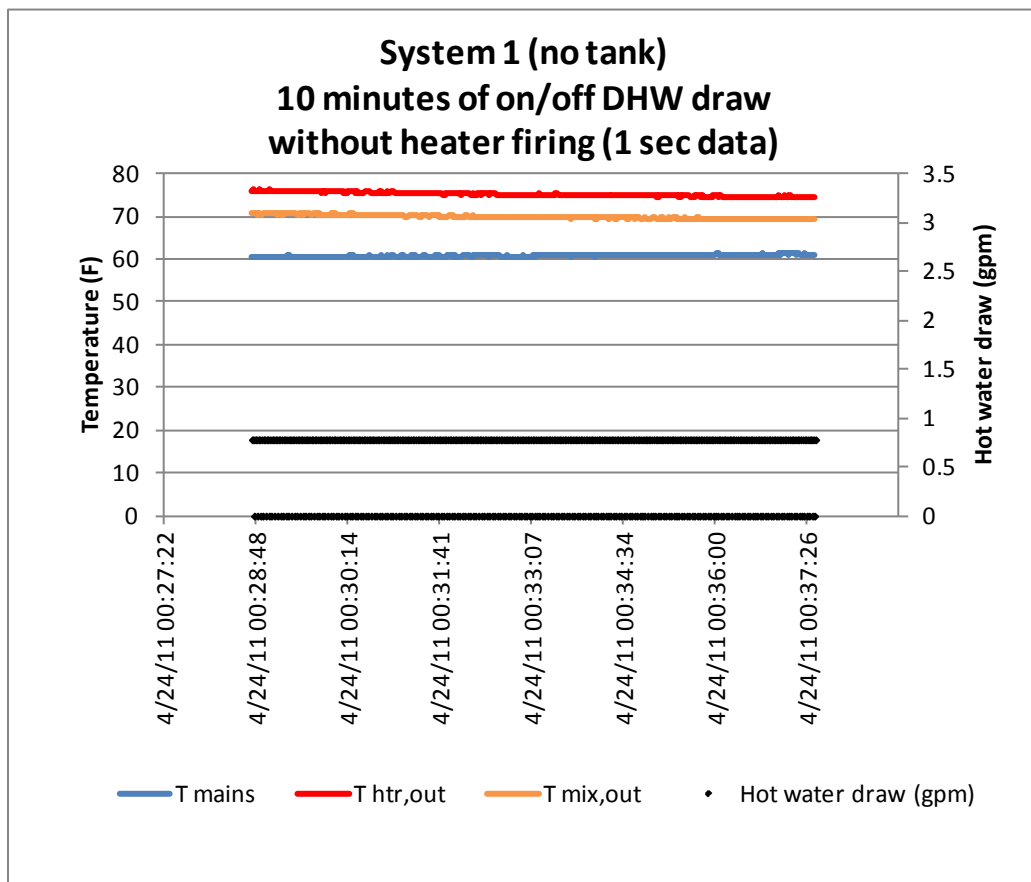

Figure 13. One second measured data from a combination system without a storage tank, showing a ten minute period with frequent low-flow on-off DHW draws without the water heater ever firing

For combination systems with TWHs, Figure 14 shows a 10 times greater cycling rate for a system without storage compared to a system with a 12 gallon storage tank, yet they both ran about the same total number of hours per day (Figure 15). Equipment life would be significantly impacted by that large of a difference in on/off cycling of moving parts, but quantification of that is not known. With many short DHW draws, much of the electrical energy consumption for the tankless combination system without storage would be for pre- and post-purge operation.

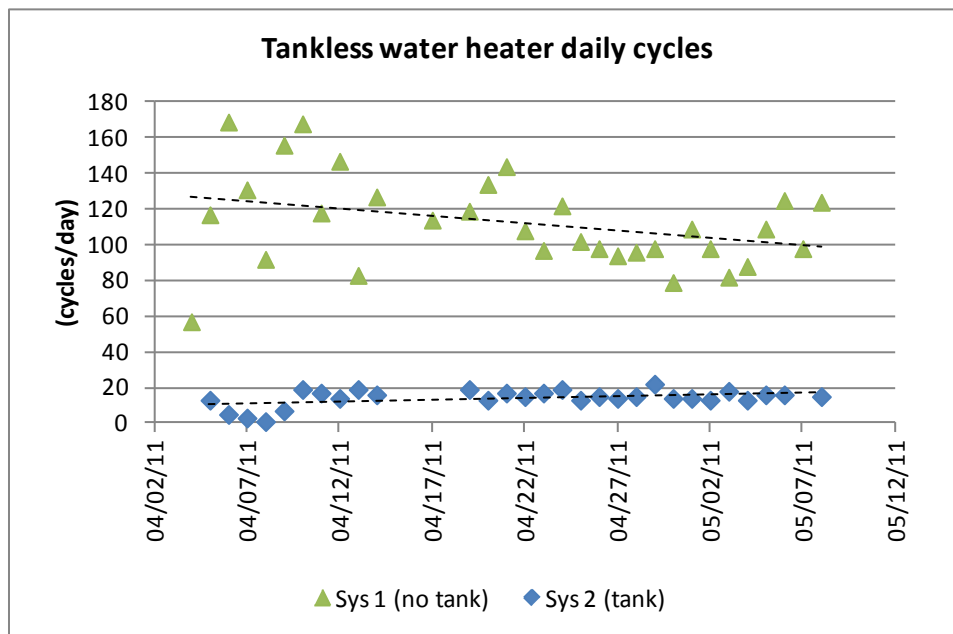

Figure 14. The combination system without storage had a cycle rate nearly 10 times that of the combination system with storage

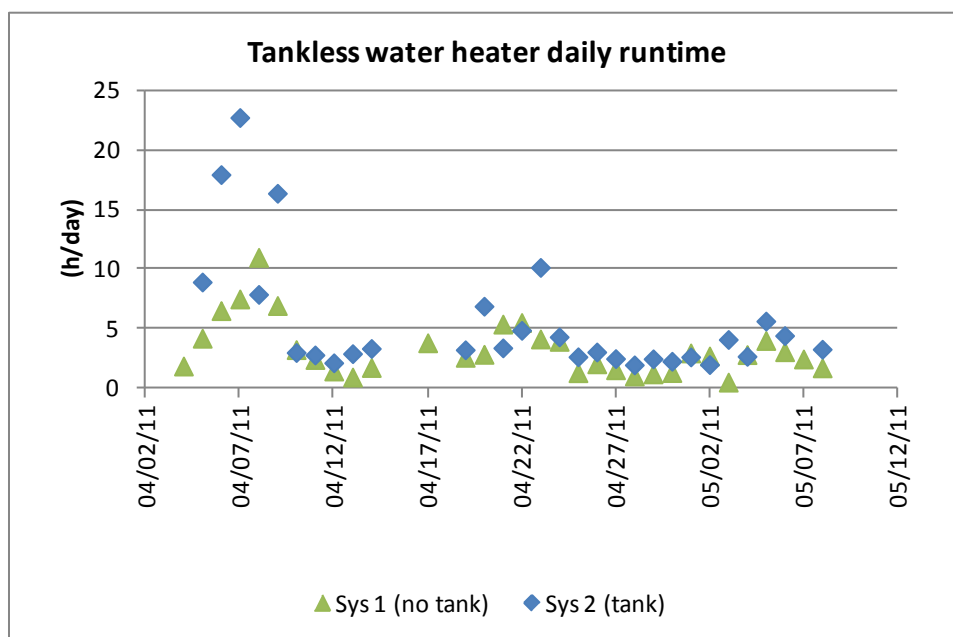

Figure 15. The combination systems ran about the same total number of hours per day, with or without storage

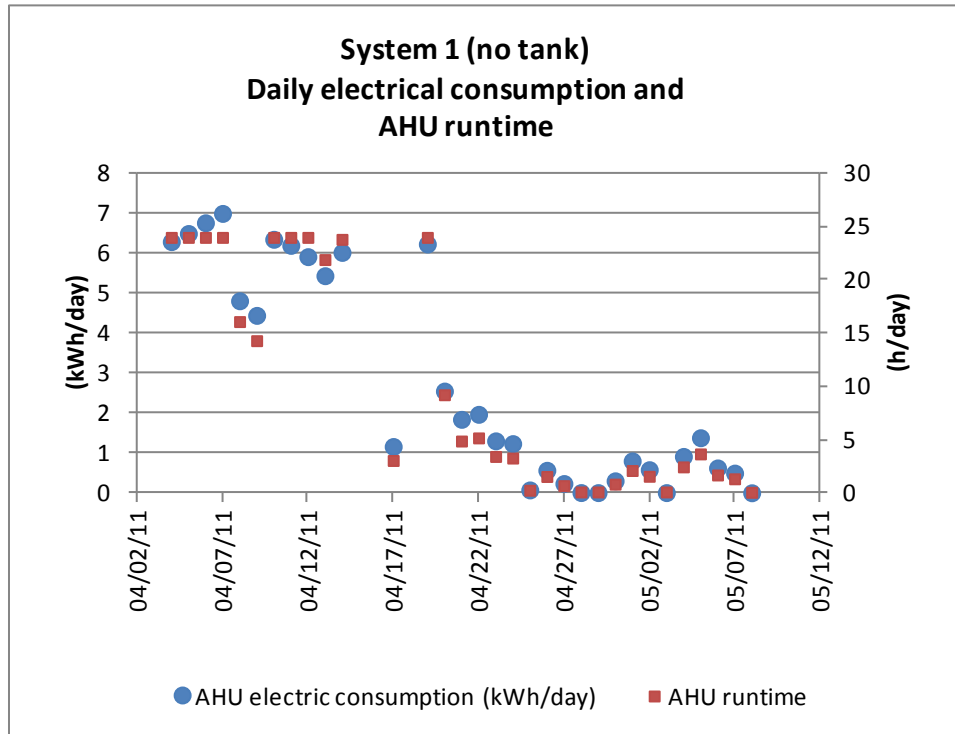

Figure 16. Electrical consumption and runtime for the hydronic air handler unit

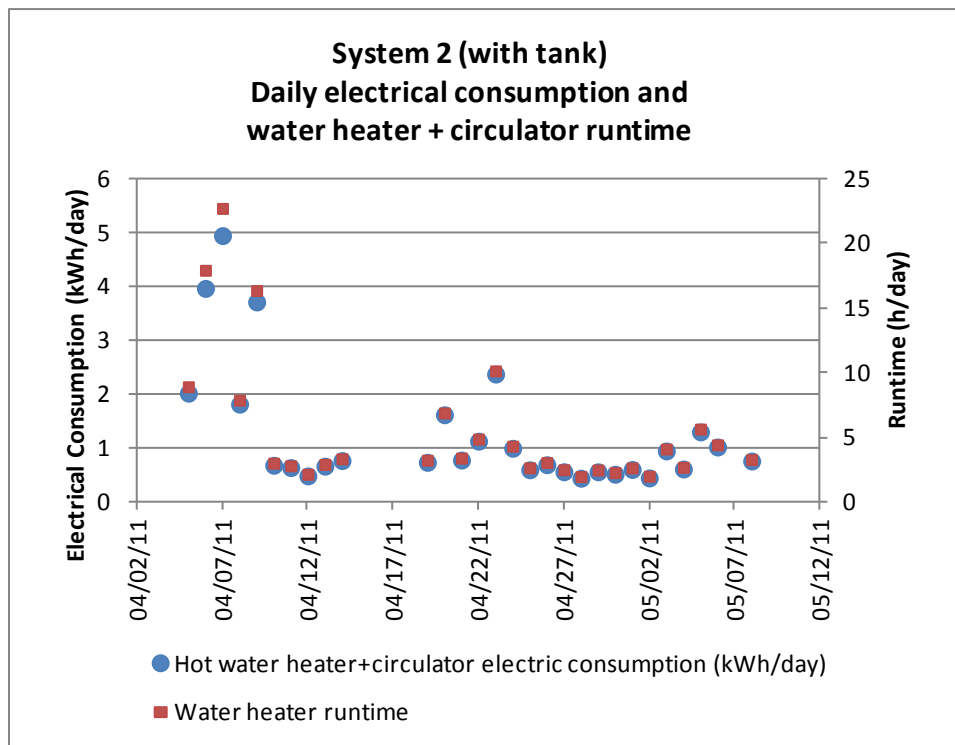

Figure 17. Combined electrical consumption and runtime for the Rinnai condensing TWH and the Taco 013 circulator

Figure 18 is an example of a short DHW demand in the middle of a heating demand where the temperature measured at the outlet of the mixing valve did not quickly respond to the DHW demand. This was typical for the combination system without the small storage tank, and could be related to pressure imbalance around the mixing valve caused by the pumped heating loop. The gradual upswing in mixing valve outlet water temperature started well before the DHW demand and was a delayed response due to heat conduction in the pipe rather than water flow through the mixing valve. Also, notice that water returning from the space heating loop remained in the condensing region of below 120°F.

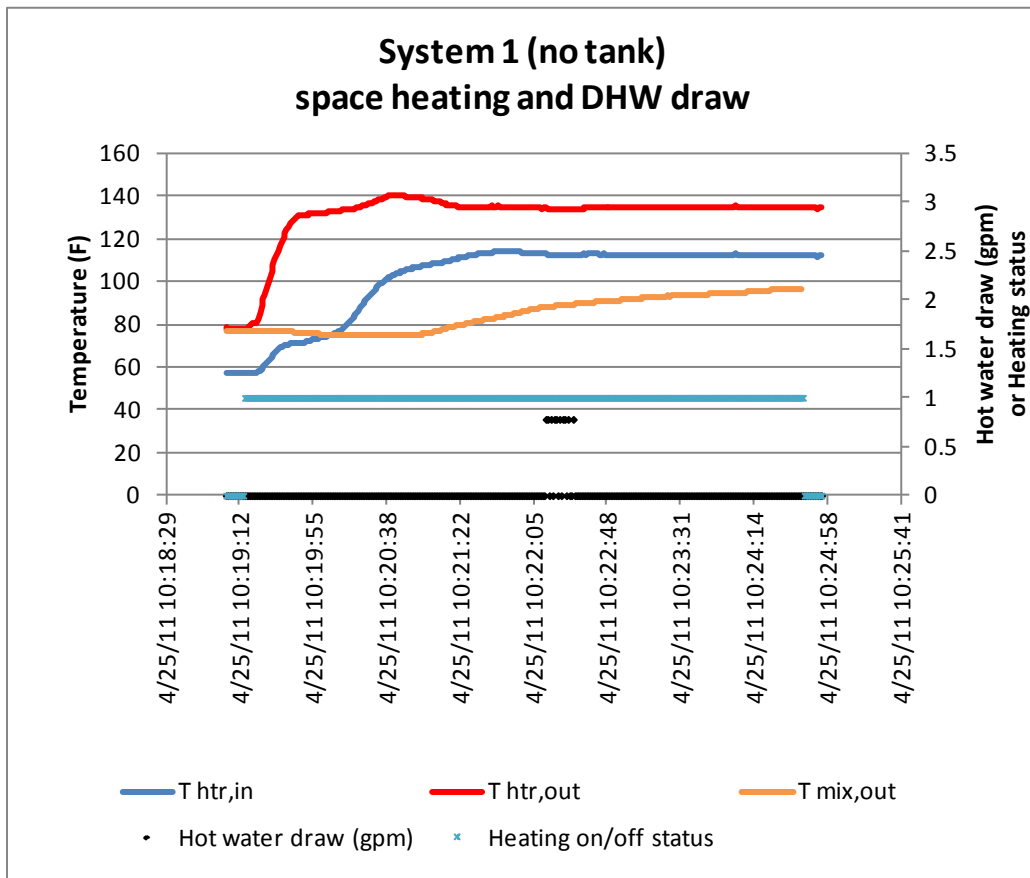

Figure 18. The combination system did not respond to a DHW demand as evidenced by no inflection of the water temperature leaving the mixing valve (the slow drift was due to conduction); note that the water heater return temperature (from the heating loop) remained in the condensing region (<120°F)

Testing has indicated that TWH efficiency changes with firing rate and water temperatures. For some systems, low firing rates result in lower efficiency. This can be attributed to a common TWH approach of feeding a single segmented burner with several gas valves to modulate capacity. To keep efficiency high at low firing rates, at least one manufacturer modulates capacity by using a full-on or full-off approach for multiple burners. In this way, when any burner is operating, it is always operating at full efficiency with the proper air fuel mix across the entire burner. This approach, however, may force a higher minimum firing rate (19 kBtu/h) than

other units (15 kBtu/h) that use the segmented burn approach, which means that the heater requires a higher flow rate and lower entering temperature before it will turn on (<70°F). This is especially problematic when trying to use solar preheated water, but it can also be a problem in southern climates where the entering water main temperature may be 75°F or higher. Some field experience in hot climates has shown that one may have to increase the hot water demand beyond what is possible with a low flow shower head to get the TWH to turn on. In a solar preheat application, this problem can be solved by using a TWH to keep a small (6 gal) insulated storage tank heated to a controlled set-point temperature rather than bringing the preheated water through the TWH.

There is a real health concern about water stagnation in combination systems where the heating circulator does not run for long periods in the off-season. Any water system with operating temperatures between 69°F and 122°F is a potential source for Legionella bacteria. Legionnaires' disease is an acute respiratory infection caused by the bacterium Legionella pneumophila, which can cause a broad spectrum of disease from mild cough and fever to serious pneumonia. Water stagnation allowing the Legionella bacteria to develop can be avoided by periodically circulating the water through the system (WHO 2011). A pump cycling timer is available with some circulators or with independent controls. In most applications, running the circulator for 1 minute will provide about one complete turnover of the water in the hydronic loop; this should be done at least once a week.

A scald prevention mixing valve is a necessary safety component in any DHW system controlled to above 120°F.

BSC is currently collecting field data to better understand the question of operating efficiency for a system with a 12-gallon insulated electric water tank as the storage volume. The additional cost of an off-the-shelf 6 to 12-gallon insulated electric water heater storage tank is about \$200. A bronze or stainless steel circulator—used to circulate water from the tank through the TWH and back—adds \$300 to \$400 to equipment cost.

Lab testing has shown that the efficiency deficit is large for at least one TWH product with a small, not-well-insulated integral storage/buffer tank (CEE 2011).

Rinnai has recently worked out a design recommendation for adding a small, field-installed storage volume, but its effect on efficiency has not been evaluated and would depend largely on how well the storage volume was insulated.

The A.O. Smith 100 kBtu/h Vertex product with condensing heat exchanger, direct-vent (2-pipe sealed combustion), and 50 gallon glass-lined tank is probably the best known overall competitor (based on capability and cost) to a combination system with a TWH and a small storage volume.

Insulating all piping and storage components of any water heating system is vitally important in order to prevent large inefficiency due to heat loss. One TWH combination system that CEE tested had a 2-gallon internal storage tank, but it and other piping components were so poorly insulated that the system lost as much heat (400 Btu/h, costing about \$40/yr) as other 50 gallon storage type (tank) water heaters tested.

4.3.2 Rating Standards

In North America, there are two test methods available for evaluating the performance of combination systems. ASHRAE Standard 124 – 2007, “Methods of Testing for Rating Combination Space-Heating and Water-Heating Appliances,” covers gas, oil and electric, for forced air and hydronic systems, yielding a Combined Annual Efficiency (CAE). CSA Standard P.9–2011 is under development and covers gas and oil, for forced air only, yielding a Thermal Performance Factor (TPF), a Composite Space Heating Efficiency (CSHE), a Water Heating Performance Factor (WHPF), and a 1-hour Water Delivery Rating (OHR) also known as a First Hour Delivery Rating.

The ASHRAE Standard 124 is deficient in a number of ways. For example, it allows for testing the components individually, but not as a complete operating system, so assessing the real combined performance is not possible. Because the testing is run only at maximum and minimum heat input, manufacturer controls (such as modulating controls) that may enhance the equipment performance have to be disabled for testing. The test method also requires prescribed temperatures and factors that may not provide a realistic rating for actual use conditions (Thomas 2011).

The CSA Standard P.9-2011 is being developed to improve on those deficiencies by allowing for customized temperature set-points and controls to test the system at the conditions in which it operates. It also calls for testing at two weighted part-load conditions (15% and 40%) as well as at the maximum input rate in heating mode.

The rating performance standards for combination systems need to be expanded and improved to encompass the new equipment and designs. That is also needed to better predict actual performance by testing and modeling more realistic use patterns and a wider range of inlet and outlet water temperatures, including for solar preheat to combination systems.

4.3.3 Gaps and Barriers to Efficient Wide Scale Implementation

There are no widely accepted standards or peer-reviewed guides for efficient combination system design. Most systems are designed and installed by trial-and-error “experts” from smaller independent heating system companies.

To optimize and monitor efficiency and comfort of combination systems, development and testing of a comprehensive control strategy is needed to coordinate the control of the heating circulator flow, air handler flow, and TWH heating output. Control parameters would be the heating water return temperature (to optimize water heating condensing efficiency), heating supply air temperature (to optimize space heating efficiency and comfort), and DHW supply temperature after the mixing valve (to optimize comfort and safety). This would require a variable speed space heating circulator and fan, modulating or staged gas valve components, and multiple temperature and flow sensors.

New factory supplied total systems are needed to overcome equipment conflicts from multiple suppliers. Improved design and control methodologies are needed to maximize benefits of combination systems. This includes predicting and achieving better consumer comfort and energy savings, for example: providing stable water temperature throughout the range of common flow rates and use patterns; assuring consistent condensing operation; fully

understanding the pros and cons of adding small storage volumes to combination systems using TWHs; and adding solar preheat to combination systems.

Critical Takeaways

For comfort, keep any DHW supply excursions above 104°F (typical shower temperature), and keep heating supply air temperature above 105°F. This will likely require heating the hot water to about 140 F and using a thermostatic mixing valve for the DHW supply. Very large hydronic coils (water to air) will allow reduction in heater output temperature but at higher equipment cost.

For condensing efficiency, keep space heating return water temperature below 120°F.

A small storage tank, actively reheated, is necessary to provide consistently warm DHW and space heating. The storage tank and piping must be very well insulated to reduce system heat losses.

A storage tank reduces water heating cycling by an order of magnitude, reducing wear and tear on moving parts, and eliminating long wait times due to pre-purge requirements or lack of burner firing.

A relatively large pre-strainer is required to extend the water heater inlet strainer service interval to annual cleaning at most.

A magnesium anode rod in the storage tank is superior in performance to an aluminum anode rod, and it will produce less strainer-clogging material. (Magnesium rods can be identified by a metal bump on top of the rod.)

All galvanized fittings should be lined with plastic to avoid scale buildup.

In retrofit applications, where possible, a new water supply line to the TWH should be installed to avoid problems with strainer-clogging material breaking loose.

Since the space heating system shares water with the potable water system, a pump cycling strategy should be employed to eliminate water stagnation in the space heating loop in the off-season.

Contractor/Homeowner Safety

DOE (August 2010). “Workforce Guidelines for Home Energy Upgrades.” Washington, DC: U.S. Department of Energy, 632 pp. (see section 7, page 331 is entitled “Crawl Spaces and Basements” and refers to safety procedures for workers who have to deal with those spaces)

References to other Guidelines, Codes and Standards

ASHRAE. (2010). ANSI/ASHRAE Standard 124. Atlanta, GA: American Society of Heating, Refrigerating and Air Conditioning Engineers, Inc.

ICC (2009). 2009 International Residential Code for One- and Two-Family Dwellings, Country Club Hills, IL: International Code Council, Inc.

References

ASHRAE. (2007). Standard 124 Methods of Testing for Rating Combination Space-Heating and Water-Heating Appliances (ANSI Approved).

ACEEE. (2011). Hot Water Forum, Combination system sessions on May, 11, 2011.
<http://www.aceee.org/conferences/2011/hwf/program#thursday>

Chandler, Michael. (2007). “Why Add a Tank to a Tankless Water Heater?” *Fine Homebuilding*, December 2007/January 2008.

Tankless Water Heaters –They’re efficient but not necessarily economical. (October 2008).
Consumer Reports. http://www.accessmylibrary.com/coms2/summary_0286-35256175_ITM

Corbin, Dave. (2011). Bosch Thermotechnology, Londonderry, NH. Presentation at U.S.DOE Building America Expert Meeting. <http://www.buildingscienceconsulting.com/services/building-america-expert-meetings.aspx>

Frizalone, Barbara. (2011). Contractor training course at Johnstone Supply, Allentown, PA, as manufacturers’ representative for Rinnai Corp. June 14, 2011.

FSEC. (2010). Energy Gauge, Energy and Economic Analysis Software,
<http://energygauge.com/>, Florida Solar Energy Center, Cocoa, FL.

Koeller, John, Klein, Gary. (2010). “A Report on Potential Best Management Practices -Tankless Water Heaters.” Prepared for The California Urban Water Conservation Council, Sacramento, CA 95814. May 2010.

LBNL. (2006). “Field and Laboratory Testing of Tankless Gas Water Heater Performance” prepared for Lawrence Berkeley National Laboratory by Davis Energy Group, April 14, 2006.

Magande, Hugh. (2011). Rinnai America Corporation, Peachtree City, GA. Presentation at U.S. DOE Building America Expert Meeting.
<http://www.buildingscienceconsulting.com/services/building-america-expert-meetings.aspx>

NFPA 2012. NFPA 54/ANSI Z223.1 - National Fuel Gas Code, 2012 Edition. National Fire Protection Association, Quincy, MA

Rinnai. (2010). Data sheet for RC80HPi condensing, tankless, temperature controlled, continuous flow, gas hot water system. Rinnai America Corporation, Peachtree City, GA.

Rinnai. (2010). Manual for 37AHB Series Hydronic Air-Handler, Rinnai America Corporation, Peachtree City, GA.

Rudd, Armin. (2011). Building Science Corporation, Somerville, MA. Presentation at U.S.DOE Building America Expert Meeting. <http://www.buildingscienceconsulting.com/services/building-america-expert-meetings.aspx>

Shoenbauer, Ben. (2011). Center for Energy and Environment, Minneapolis, MN. Presentation at U.S.DOE Building America Expert Meeting.

<http://www.buildingscienceconsulting.com/services/building-america-expert-meetings.aspx>

Thomas, Martin. (2011). Natural Resources Canada, Ottawa, Ontario, Canada. Presentation at U.S. DOE Building America Expert Meeting.

<http://www.buildingscienceconsulting.com/services/building-america-expert-meetings.aspx>

WHO. (2011). "Water safety in buildings." World Health Organization. ISBN 978 92 4 154810 6

Weingarten, Larry. (2011). Presentation at U.S. DOE Building America Expert Meeting.

<http://www.buildingscienceconsulting.com/services/building-america-expert-meetings.aspx>

buildingamerica.gov

U.S. DEPARTMENT OF
ENERGY | Energy Efficiency &
Renewable Energy

DOE/GO-102012-3576 • August 2012

Printed with a renewable-source ink on paper containing at least 50% wastepaper, including 10% post-consumer waste.

BA-1206: Measure Guidelin: Combination Forced-Air Space and Tankless Domestic Hot Water Heating Systems

About this Report

This report was prepared with the cooperation of the U.S. Department of Energy's Building America Program.

About the Author

Armin Rudd is a principal engineer at Building Science Corporation in Somerville, Massachusetts. More information about Armin Rudd can be found at www.buildingscienceconsulting.com.

Direct all correspondence to: Building Science Corporation, 30 Forest Street, Somerville, MA 02143.

Limits of Liability and Disclaimer of Warranty:

Building Science documents are intended for professionals. The author and the publisher of this article have used their best efforts to provide accurate and authoritative information in regard to the subject matter covered. The author and publisher make no warranty of any kind, expressed or implied, with regard to the information contained in this article.

The information presented in this article must be used with care by professionals who understand the implications of what they are doing. If professional advice or other expert assistance is required, the services of a competent professional shall be sought. The author and publisher shall not be liable in the event of incidental or consequential damages in connection with, or arising from, the use of the information contained within this Building Science document.