

Joseph Lstiburek, Ph.D., P.Eng, ASHRAE Fellow

# Building Science

---

## Towering Inferno

[www.buildingscience.com](http://www.buildingscience.com)

# Setting The Stage

Grenfell Tower

North Kensington, United Kingdom

June, 2017

















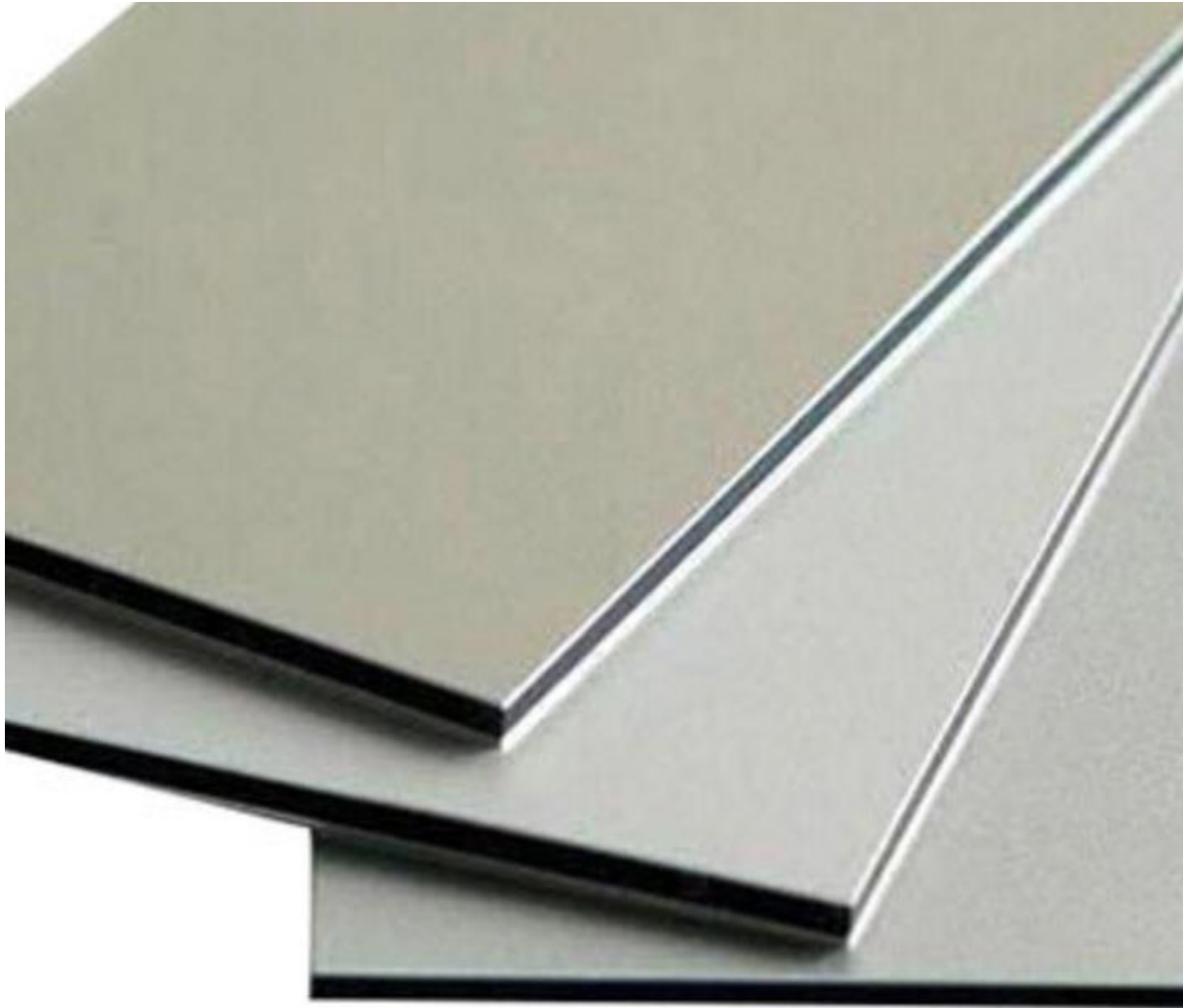



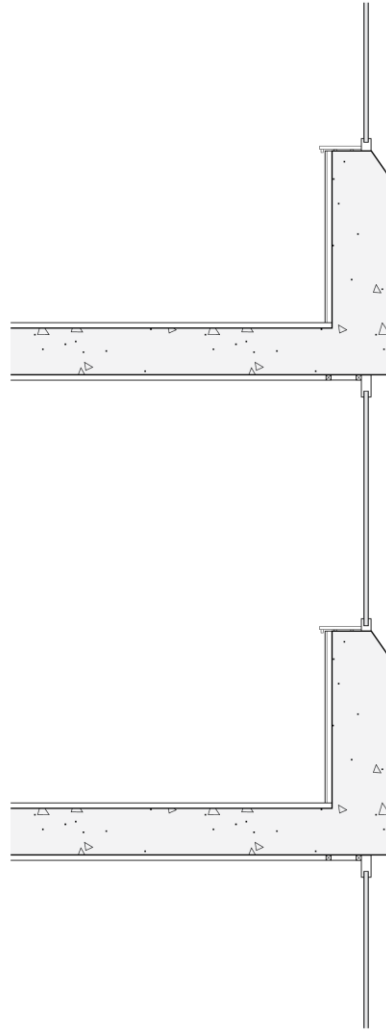

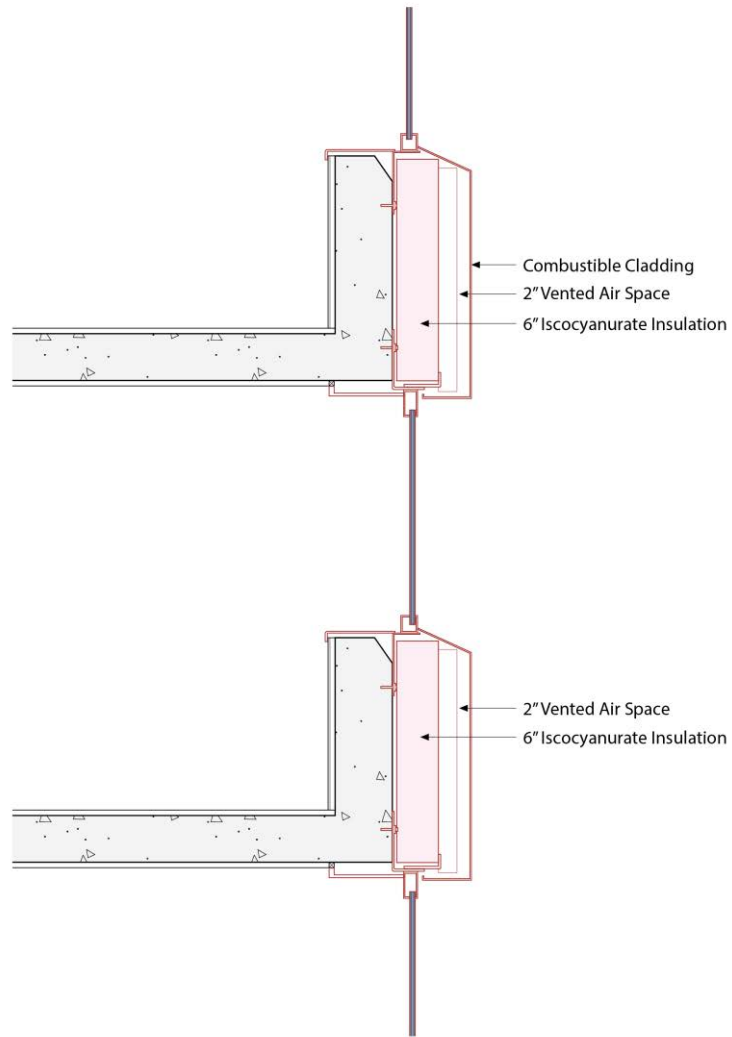



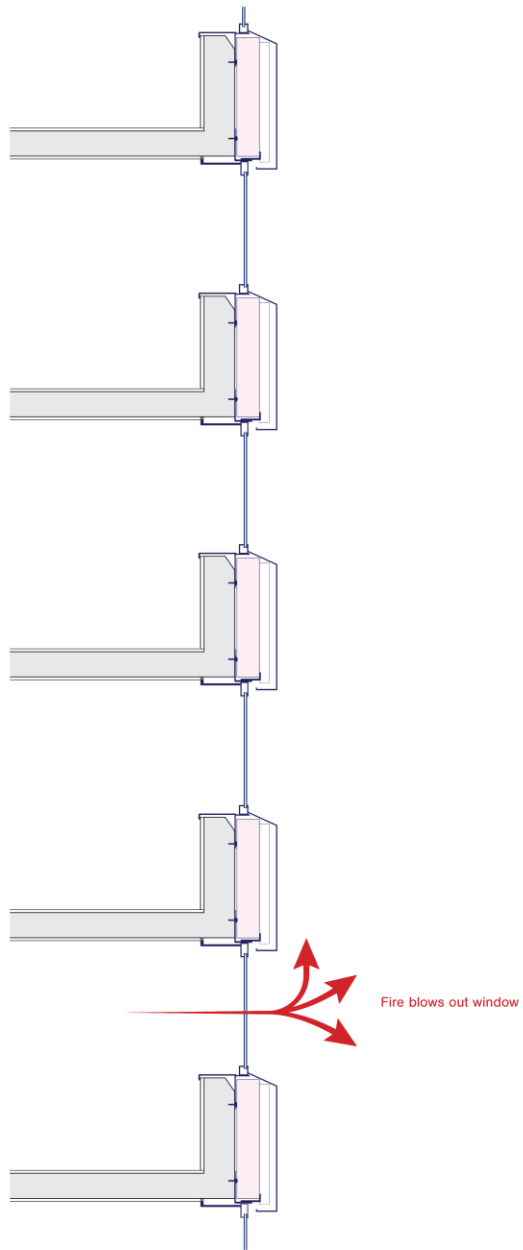

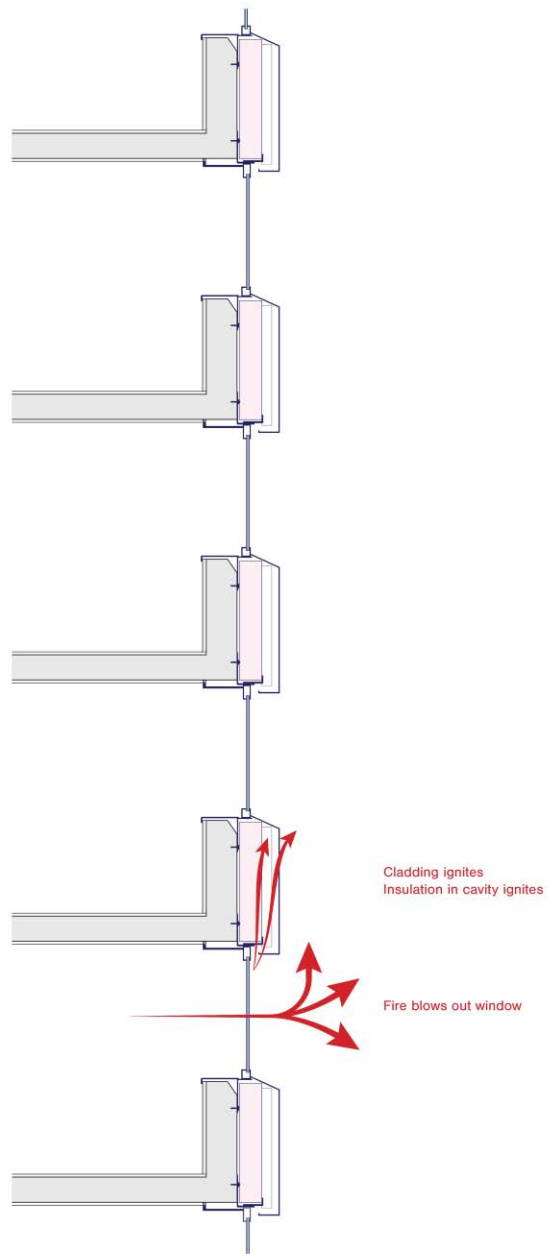

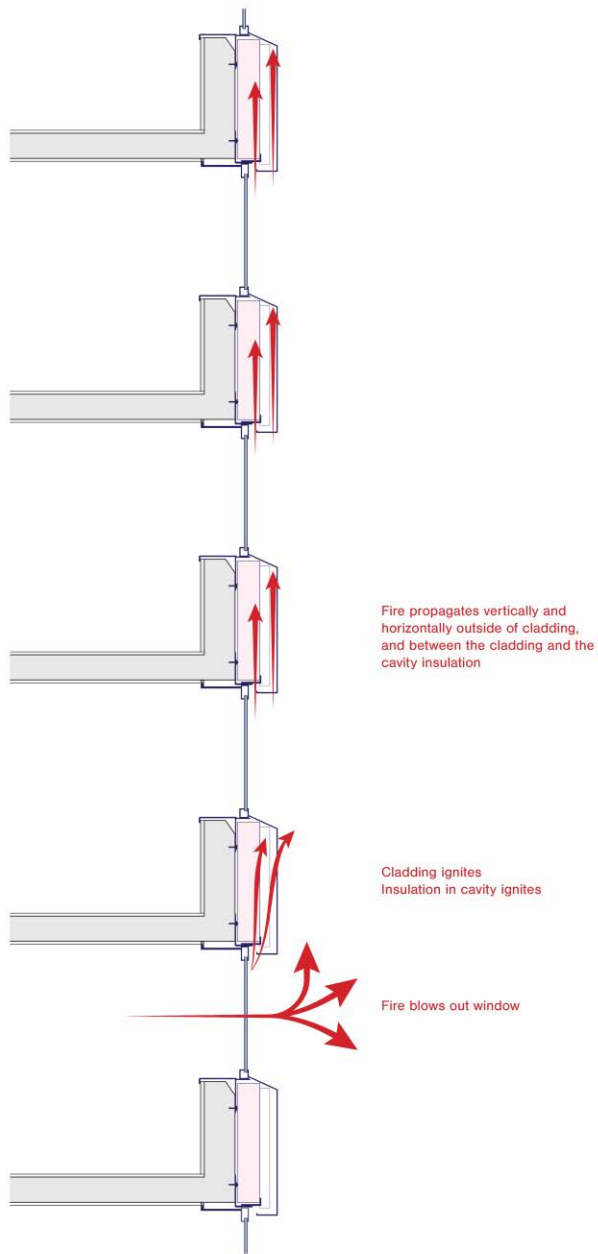

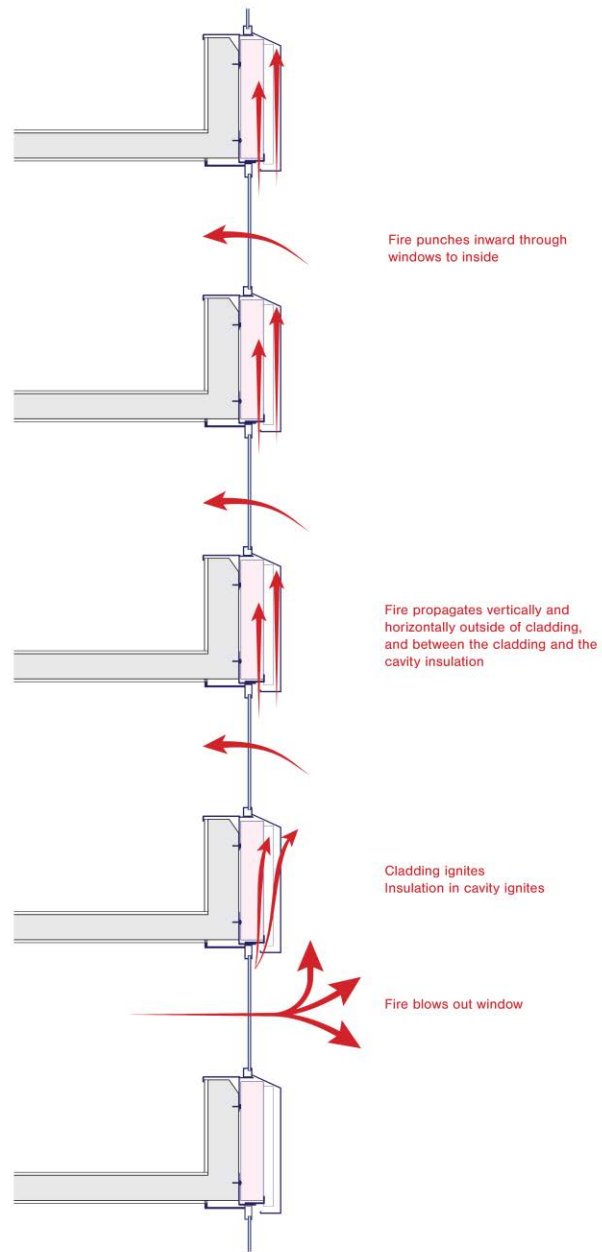



Dubai Address Hotel  
Dubai, United Arab Emirates  
January, 2015





Mermoz Roubaix, France  
May 2012





Tamweel Tower

Dubai, United Arab Emirates

November, 2012







Al Nahda Tower  
Sharjah, United Arab Emirates  
April, 2012





Polat Tower  
Istanbul, Turkey  
July, 2012







Dubai Torch Tower  
Dubai, United Arab Emirates  
August, 2017

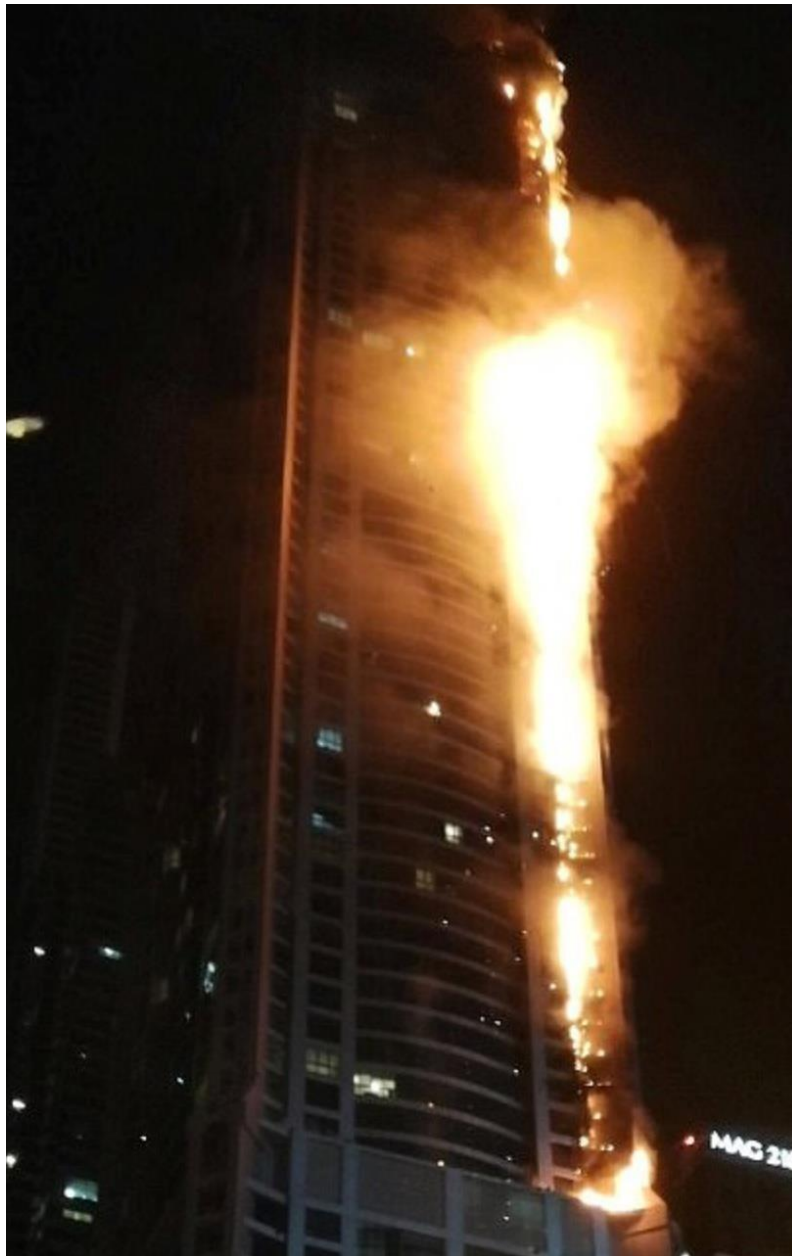



Thorn House Hotel  
Rostov-on-Don, Grozny, Chechnya  
September, 2017







Marco Polo Apartments  
Honolulu, Hawaii  
July, 2017









# Cladding Attachment





# Hooker Chemical Building Niagara Falls, New York







John E. Jaqua Academic Center  
University of Oregon,  
Eugene, Oregon







# Stattdor Building Dusseldorf, Germany







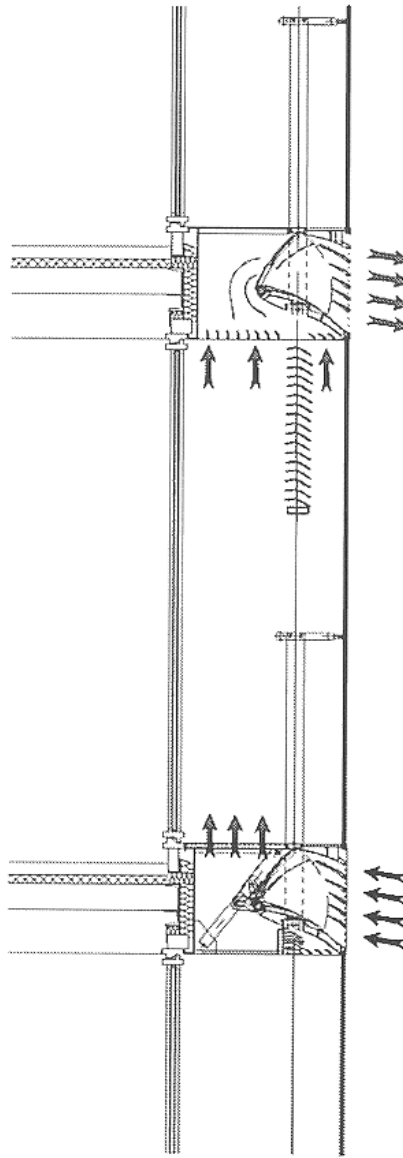

# Where I Grew Up



























