

Joseph Lstiburek, Ph.D., P.Eng, ASHRAE Fellow

Building Science

Rain Control

www.buildingscience.com



Building Science Corporation

Joseph Lstiburek – Rain Control 2



Building Science Corporation

Joseph Lstiburek – Rain Control 3



Building Science Corporation

Joseph Lstiburek – Rain Control 4

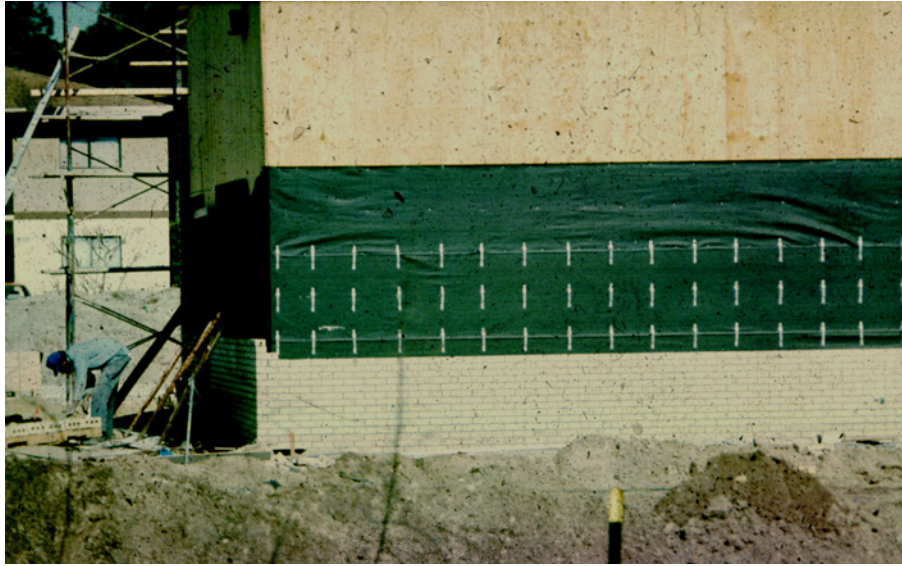

Building Science Corporation

Joseph Lstiburek – Rain Control 5

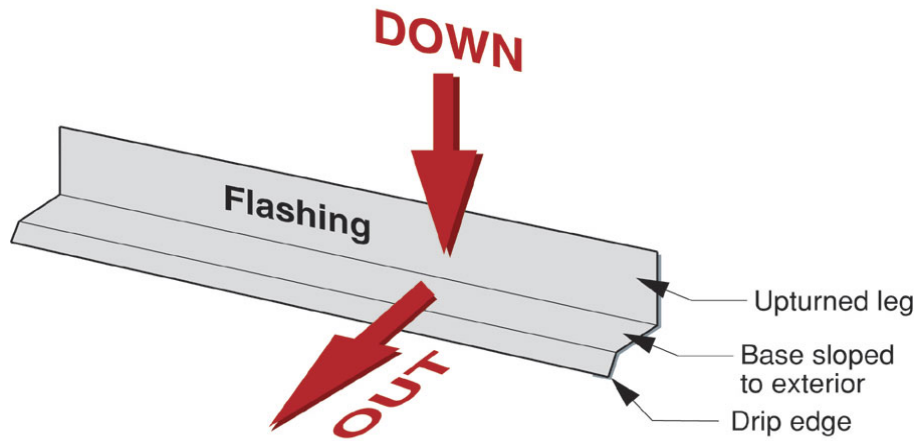

Building Science Corporation

Joseph Lstiburek – Rain Control 6

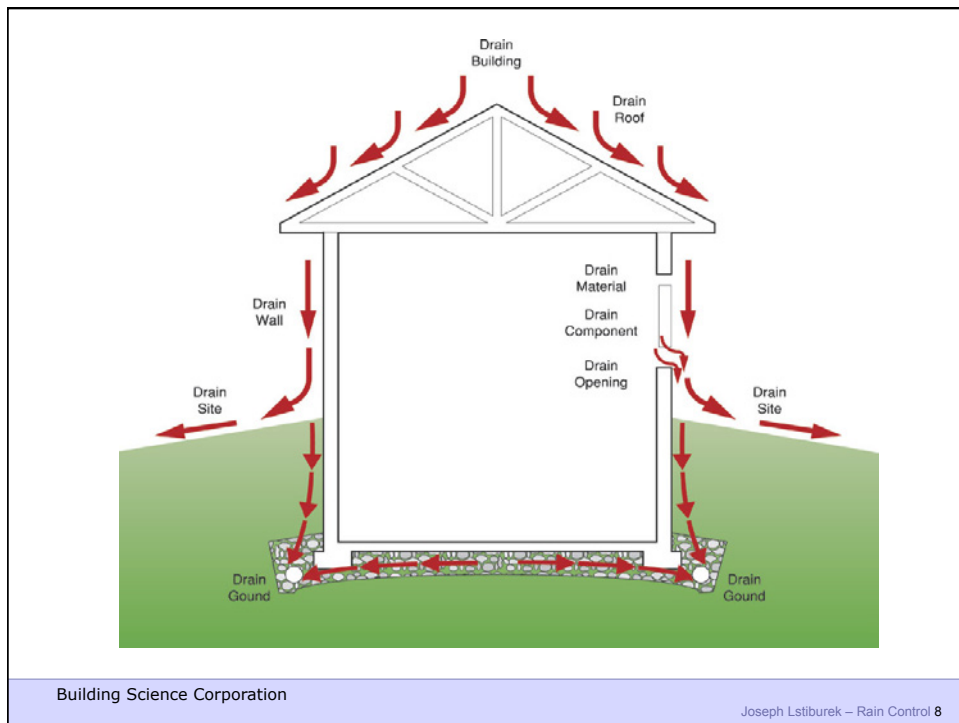
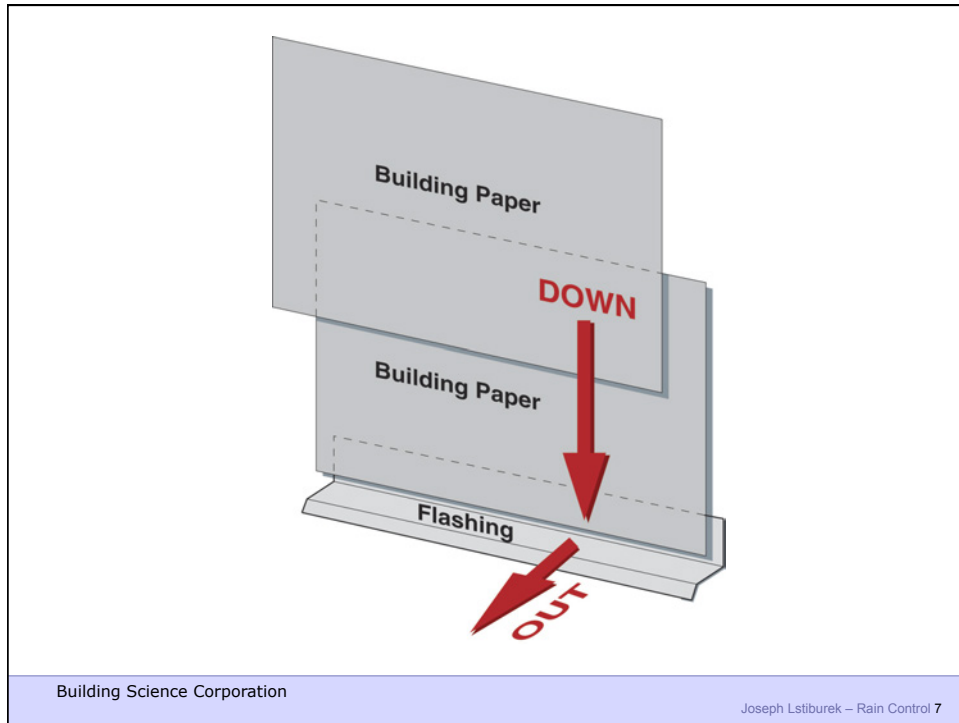

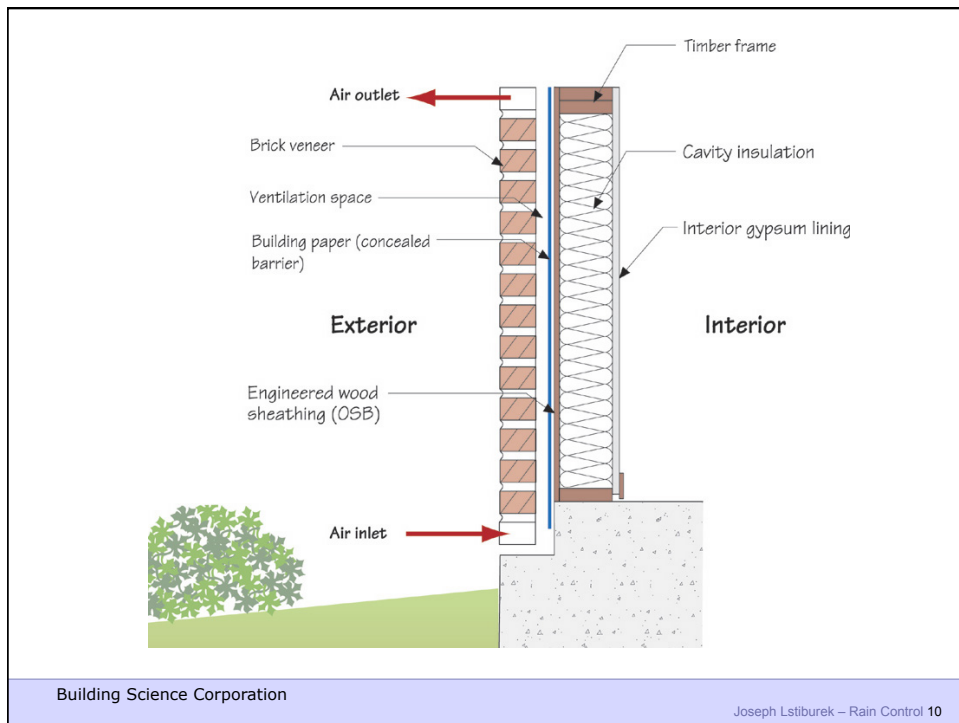
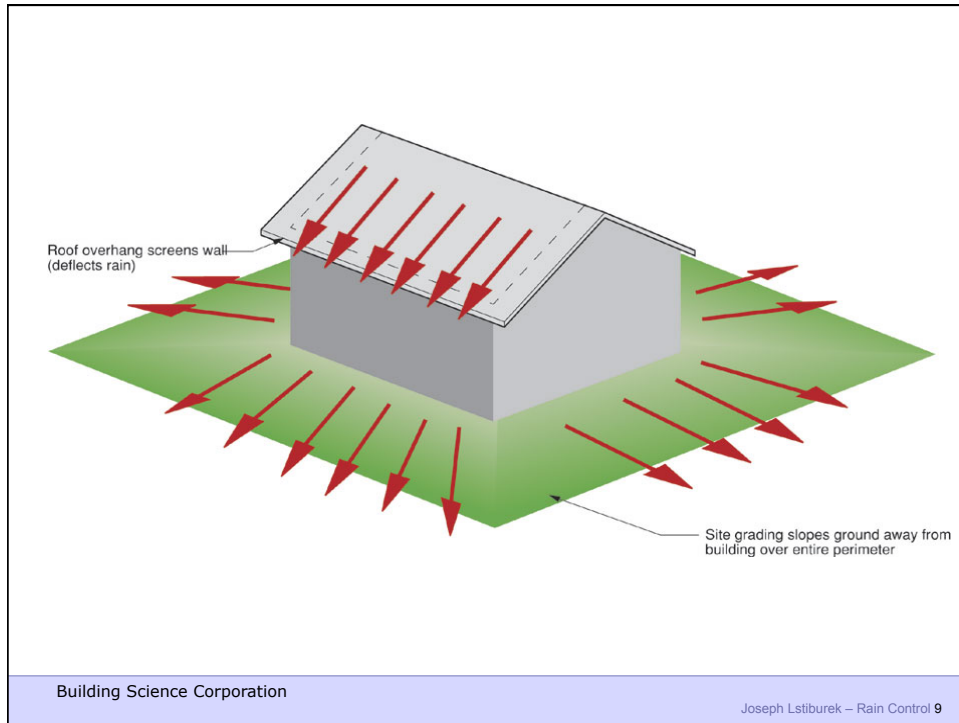



Building Science Corporation

Joseph Lstiburek – Rain Control 11



Building Science Corporation

Joseph Lstiburek – Rain Control 12



Building Science Corporation



Building Science Corporation



Building Science Corporation

Joseph Lstiburek – Rain Control 15



Building Science Corporation

Joseph Lstiburek – Rain Control 16



Building Science Corporation

Joseph Lstiburek – Rain Control 17



Building Science Corporation

Joseph Lstiburek 18

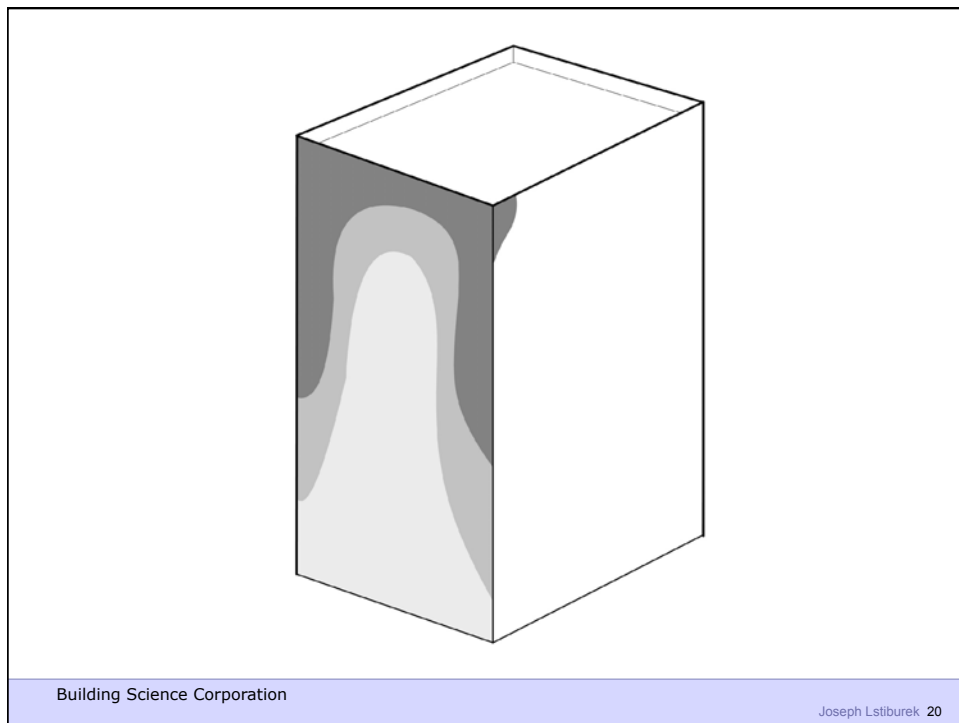
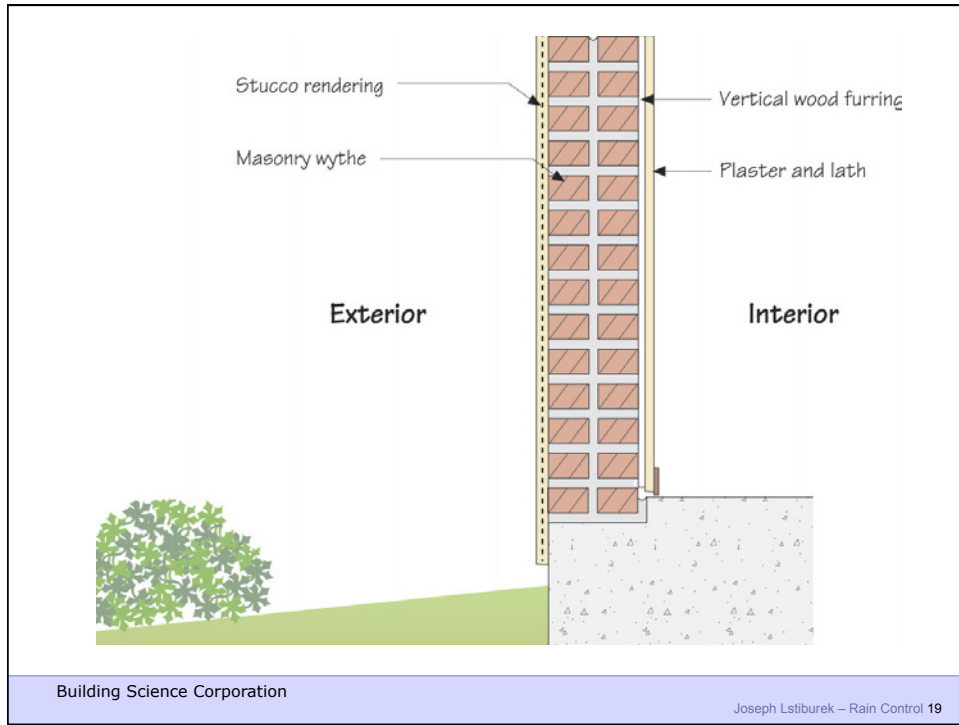



Building Science Corporation

Joseph Lstiburek 21



Building Science Corporation

Joseph Lstiburek 22

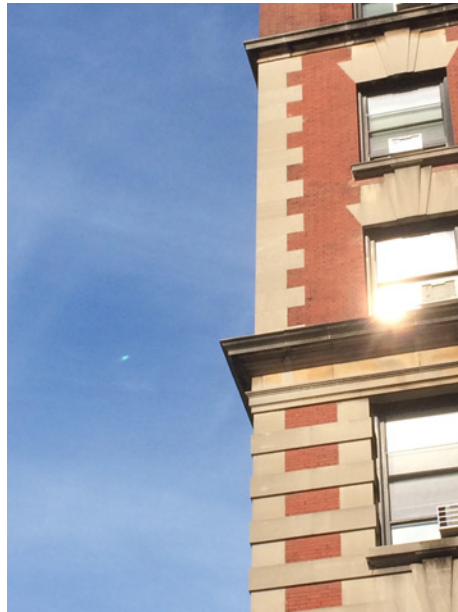

Building Science Corporation

Joseph Lstiburek 23



Building Science Corporation

Joseph Lstiburek 24

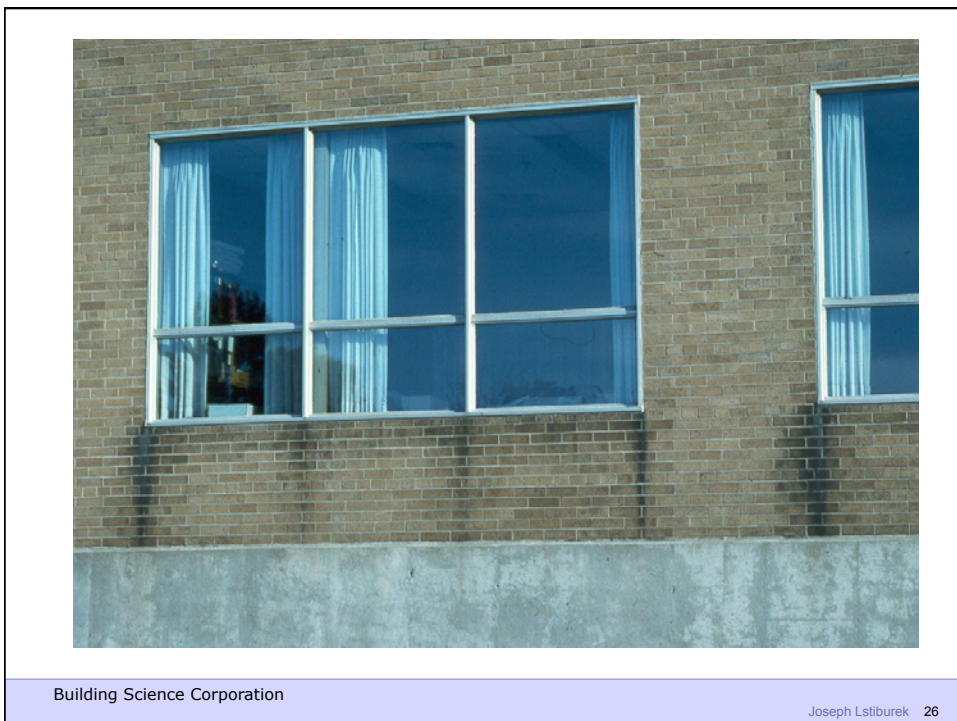

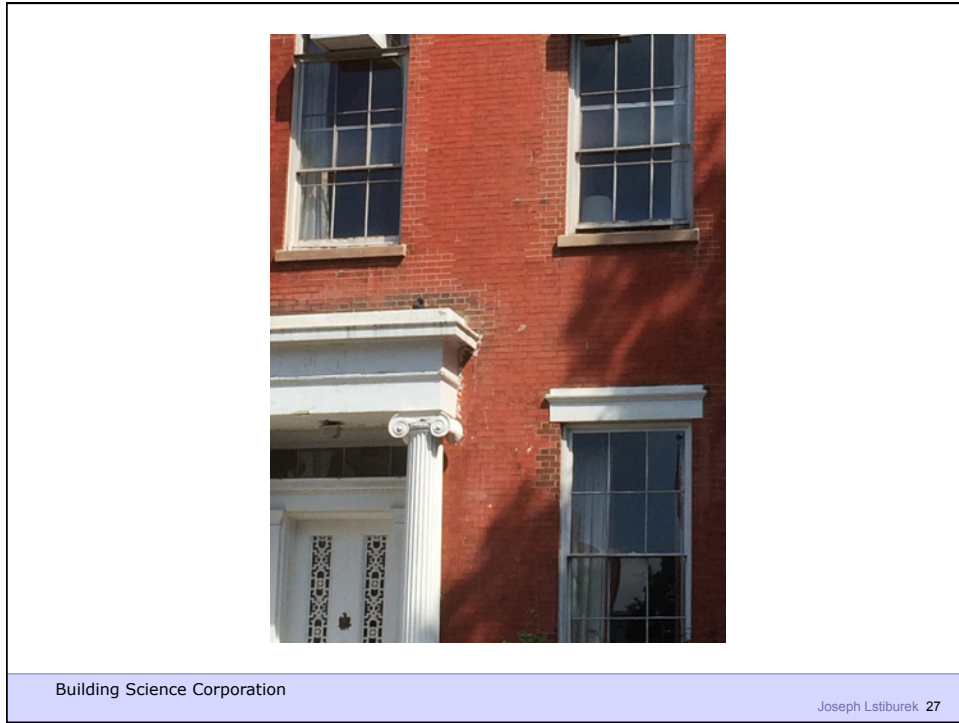





Building Science Corporation



Building Science Corporation





Building Science Corporation

Joseph Lstiburek – Rain Control 35

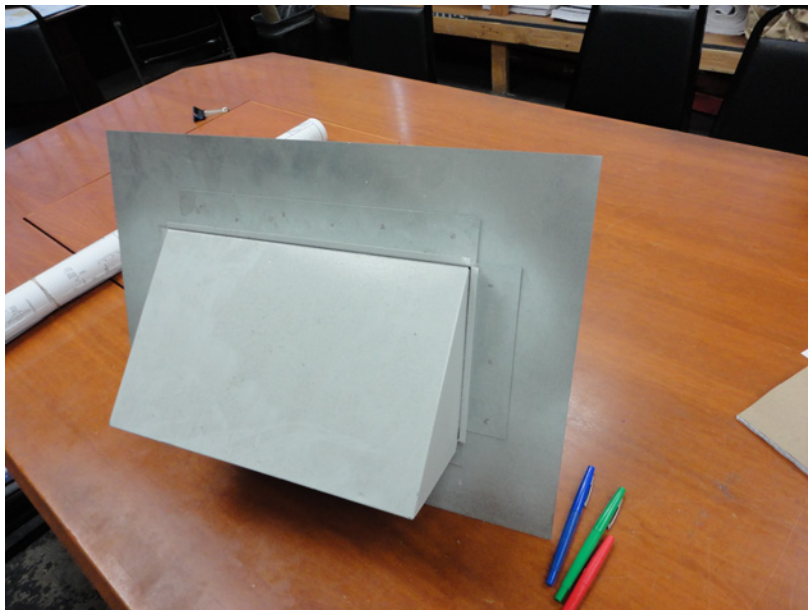

Building Science Corporation

Joseph Lstiburek 36



Building Science Corporation

Joseph Lstiburek – Rain Control 37



Building Science Corporation

Joseph Lstiburek 38



Building Science Corporation

Joseph Lstiburek 39



Building Science Corporation

Joseph Lstiburek 40



Building Science Corporation

Joseph Lstiburek 41

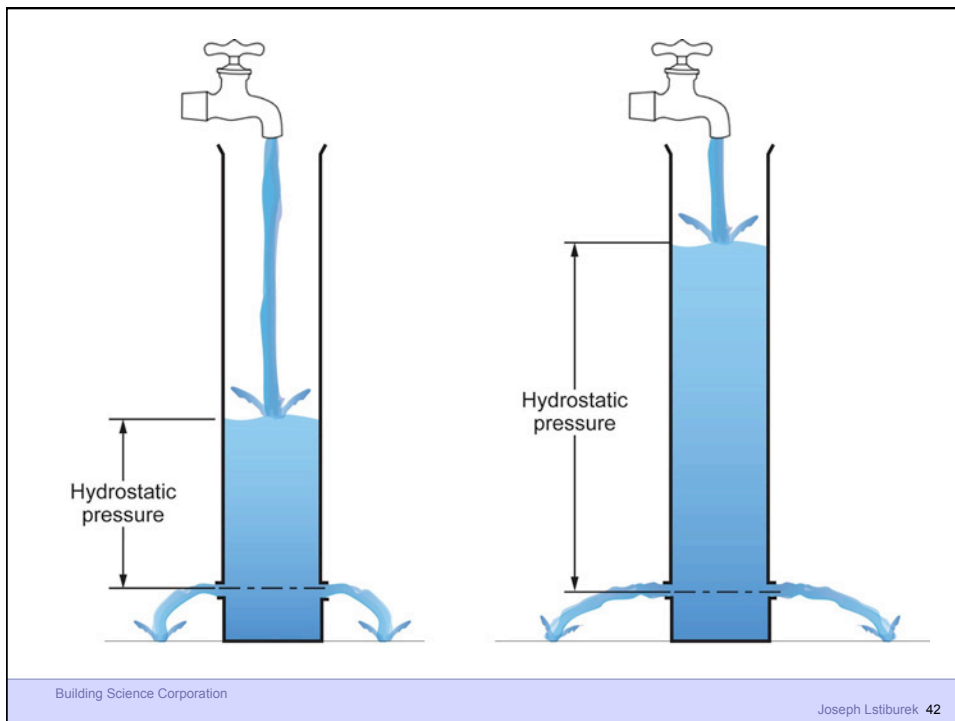

Building Science Corporation

Joseph Lstiburek 42



Building Science Corporation

Joseph Lstiburek 43

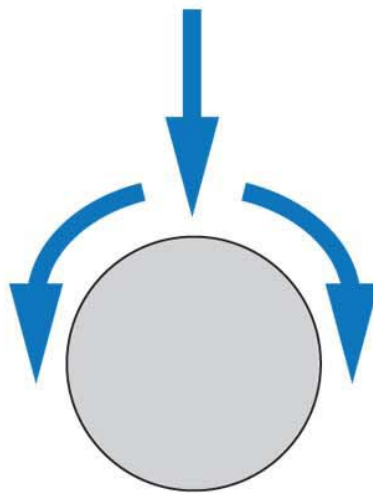

Building Science Corporation

Joseph Lstiburek 44

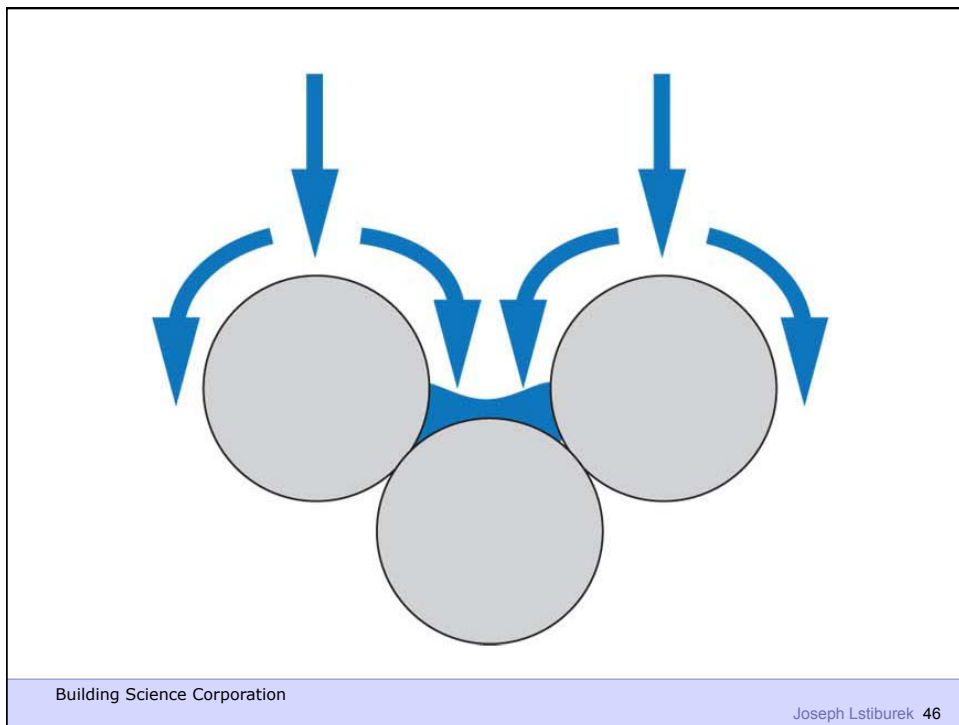
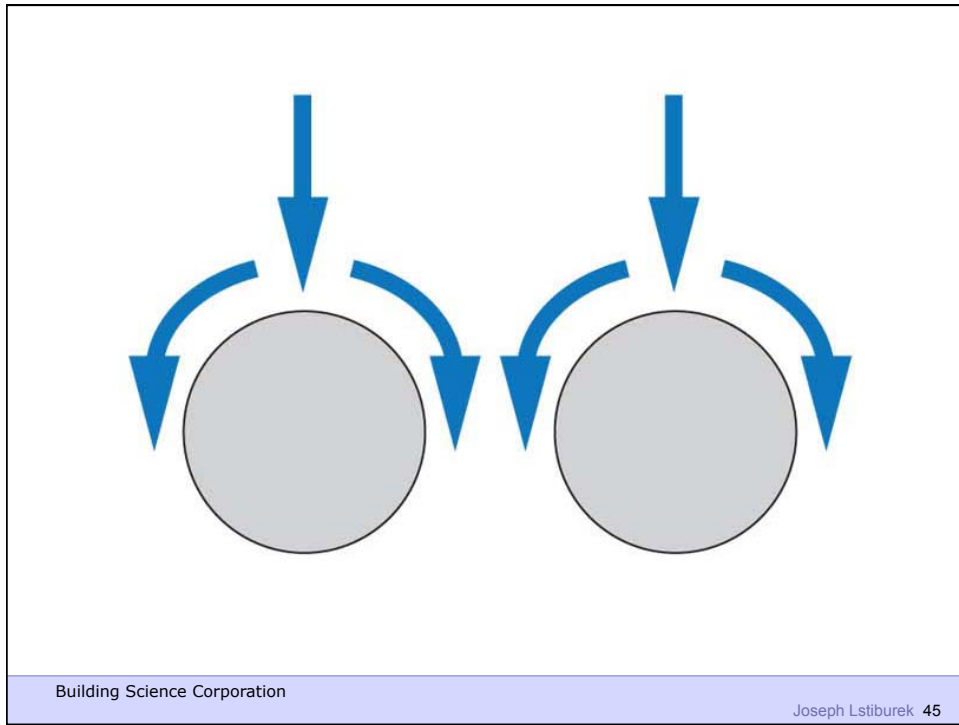



Building Science Corporation

Joseph Lstiburek 47

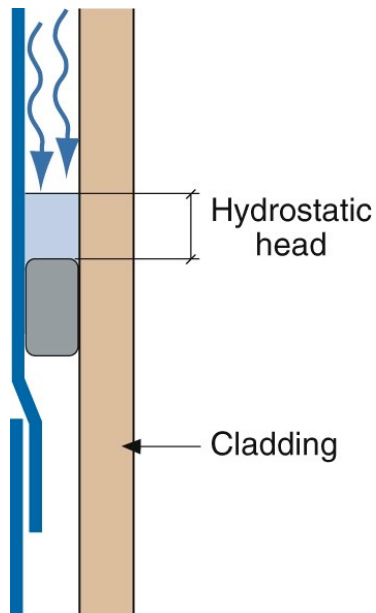

Building Science Corporation

Joseph Lstiburek 48

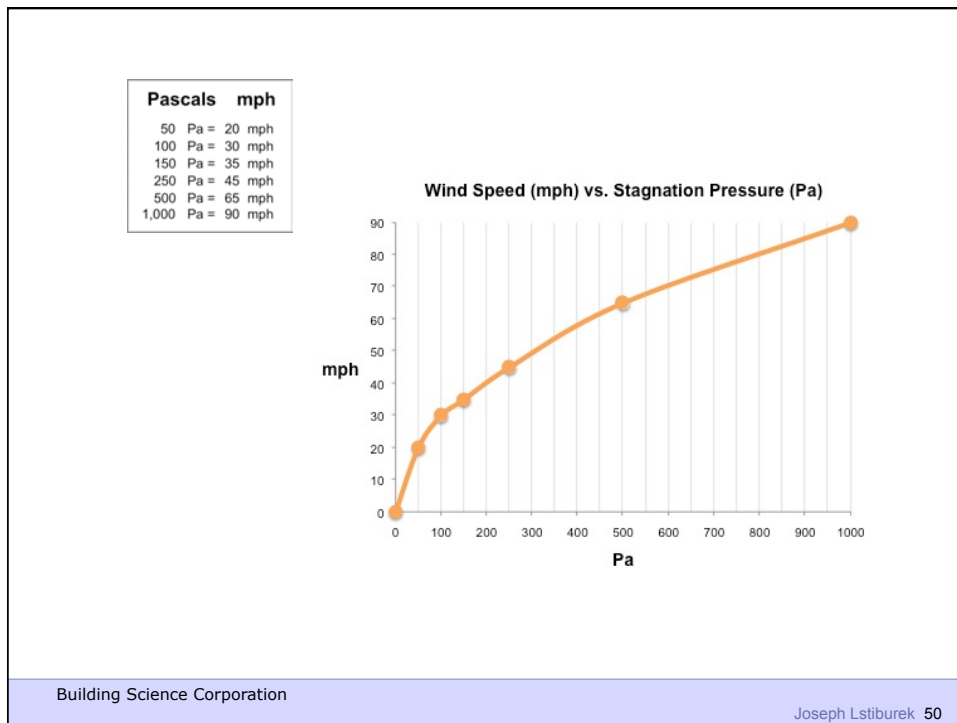
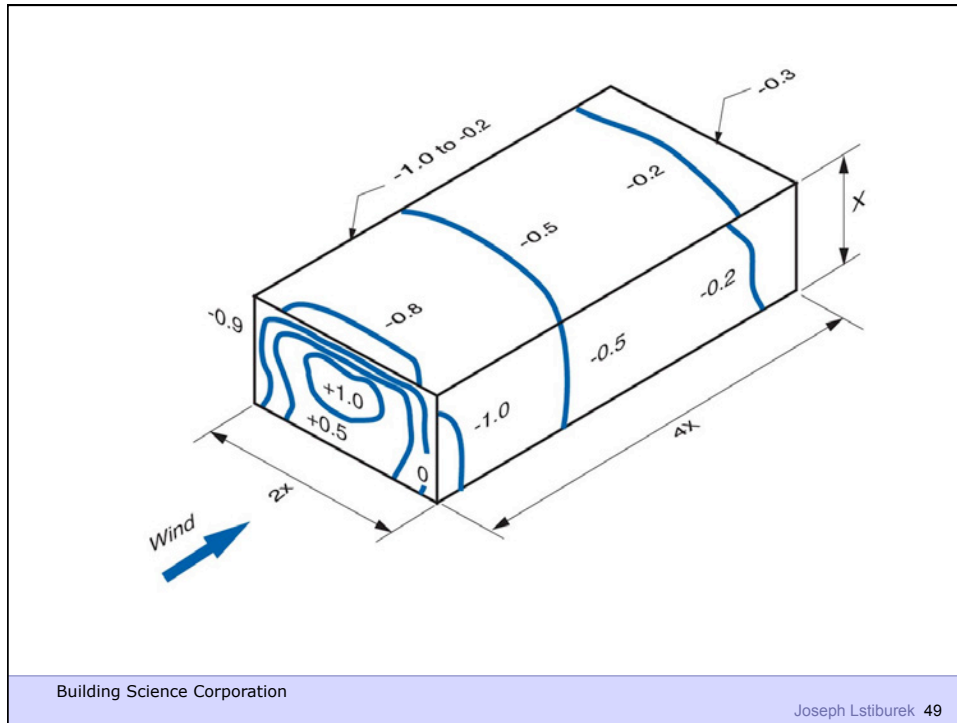



Building Science Corporation

Joseph Lstiburek 51

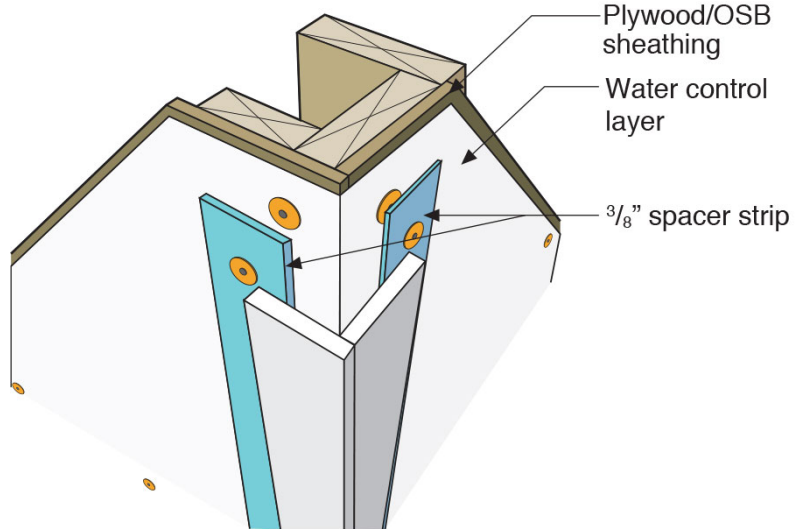

Building Science Corporation

Joseph Lstiburek 52

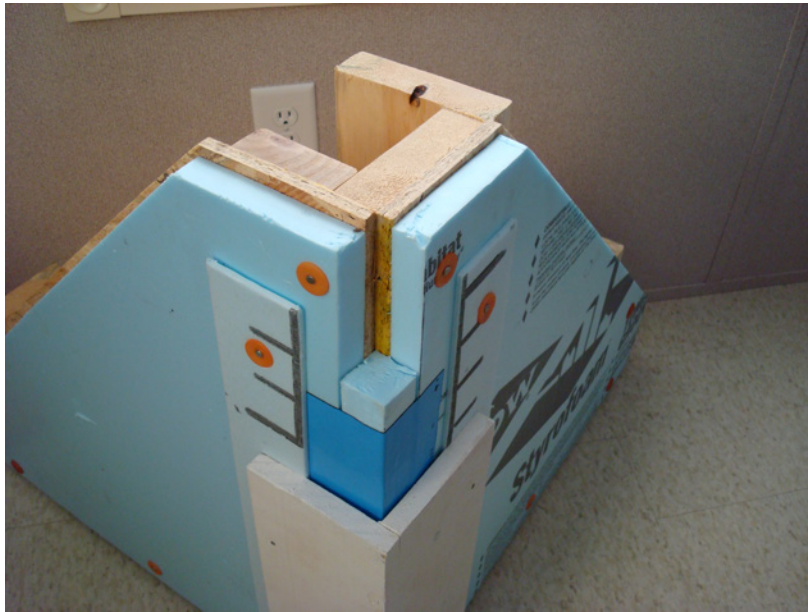

Building Science Corporation

Joseph Lstiburek 53



Building Science Corporation

Joseph Lstiburek 54

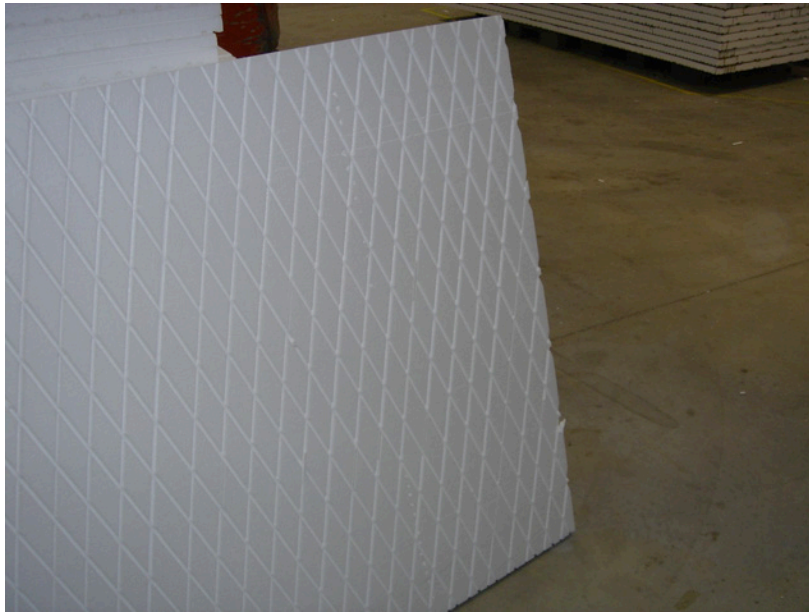

Building Science Corporation

Joseph Lstiburek 55



Building Science Corporation

Joseph Lstiburek 56

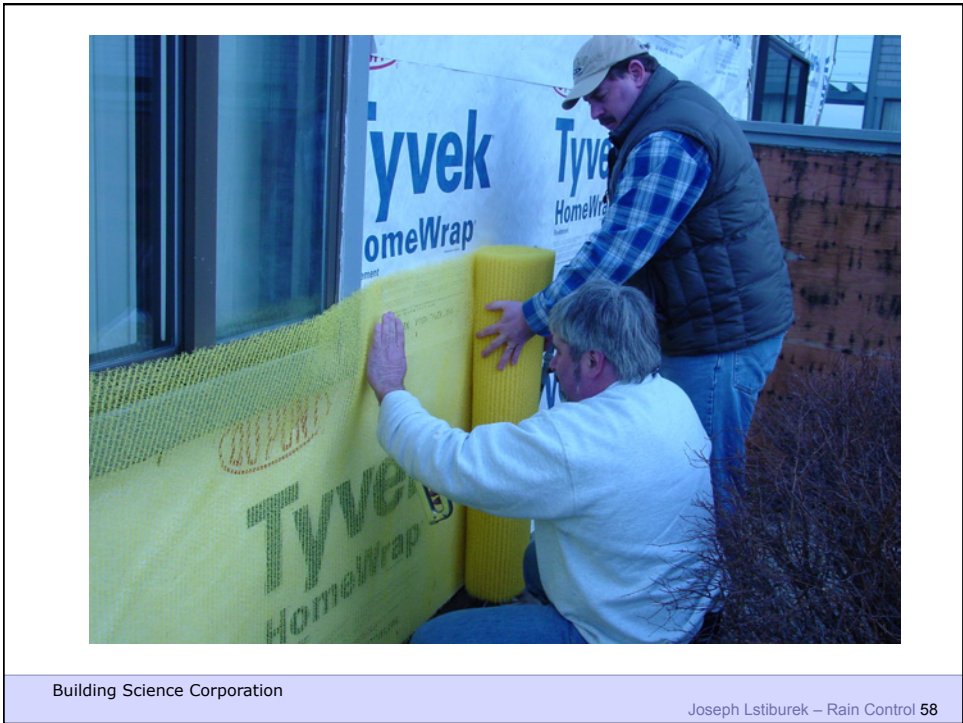
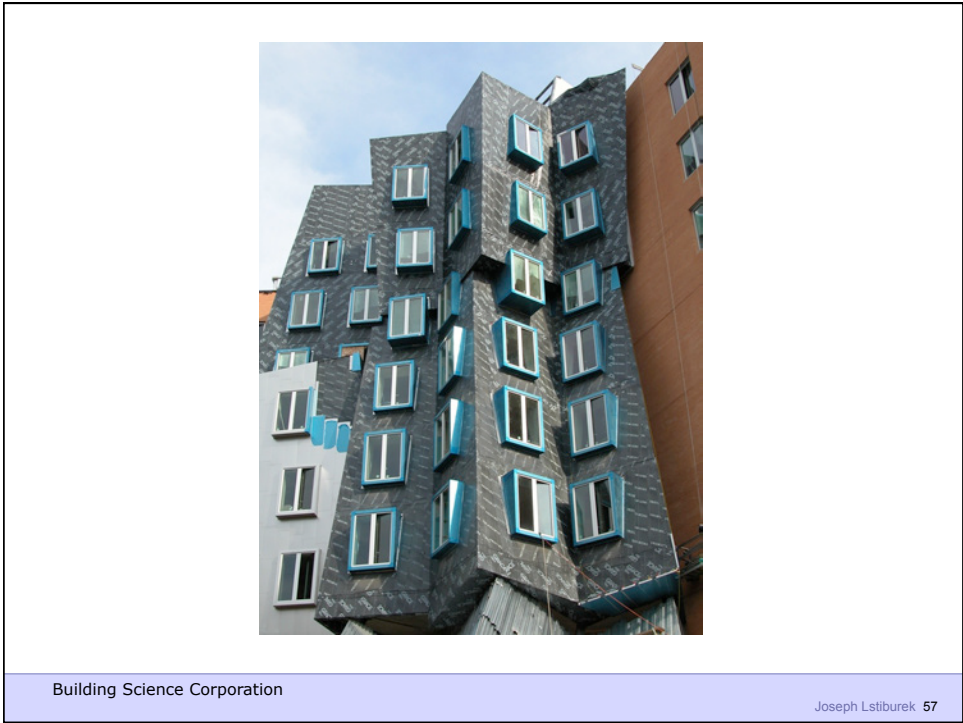



Building Science Corporation

Joseph Lstiburek – Rain Control 59

Rain enters cup
due to momentum
("kinetic energy")

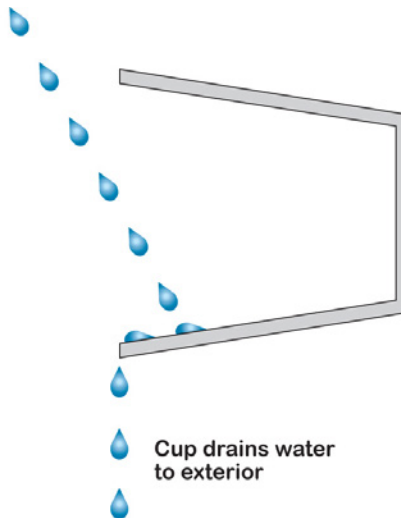

Building Science Corporation
2011

Joseph Lstiburek 60

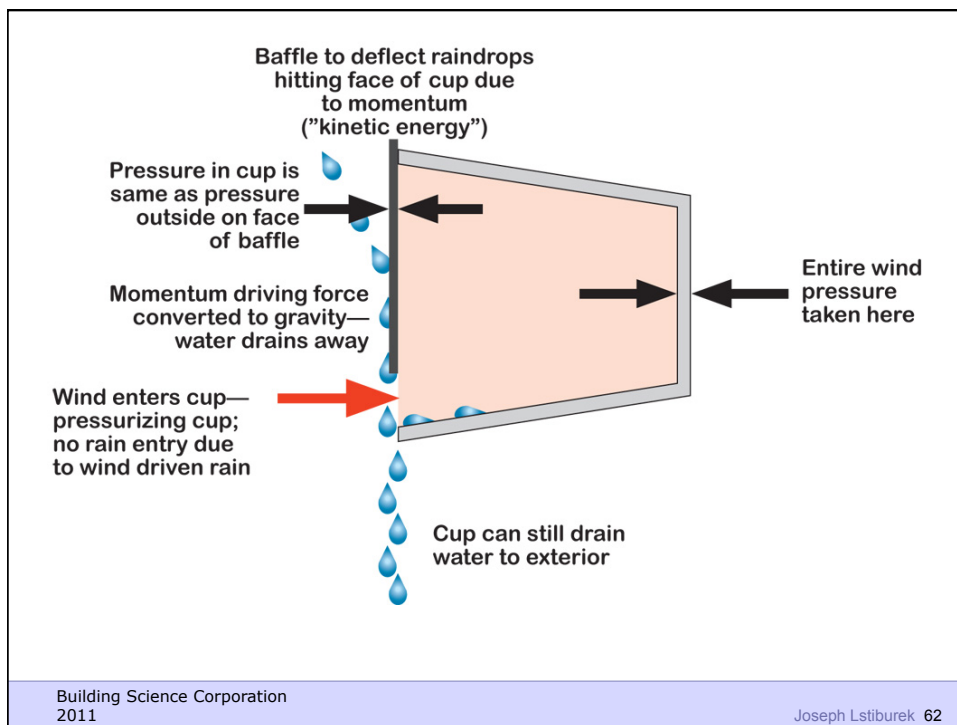
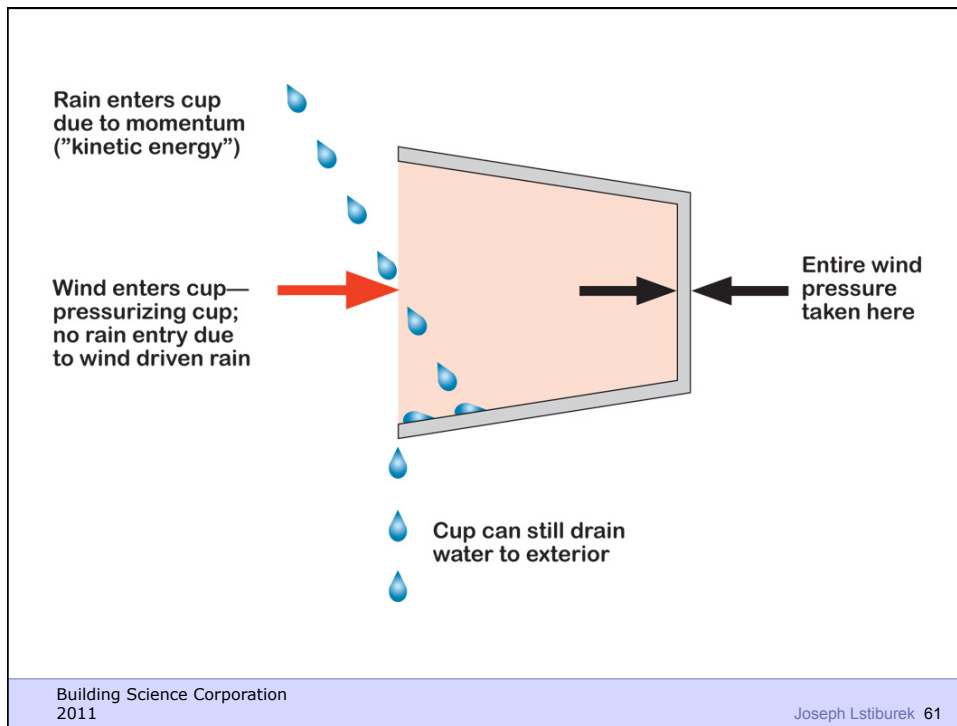

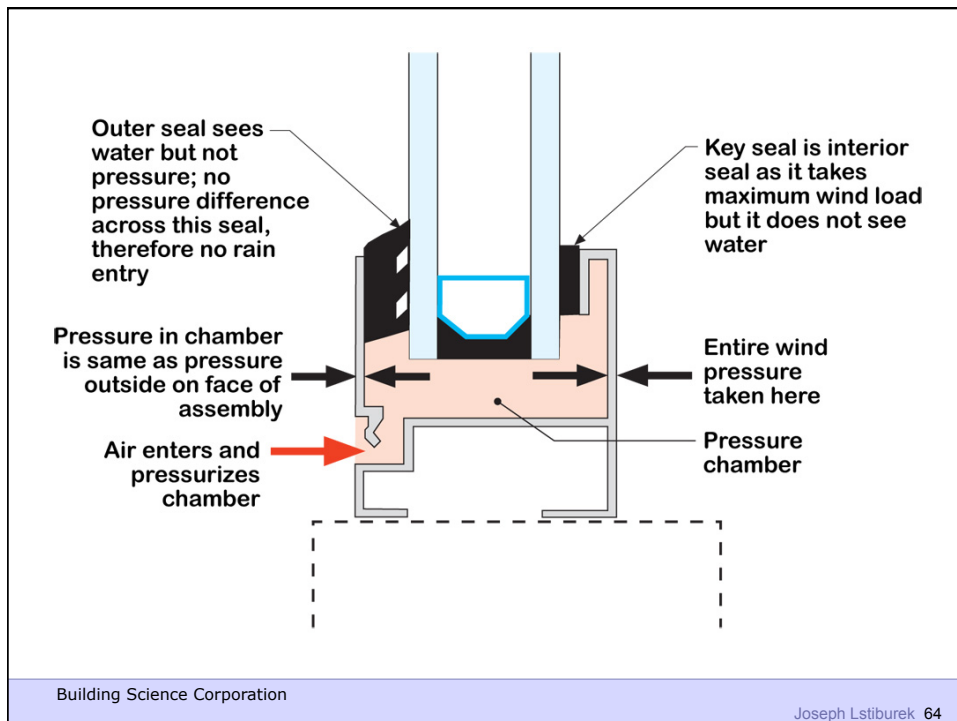
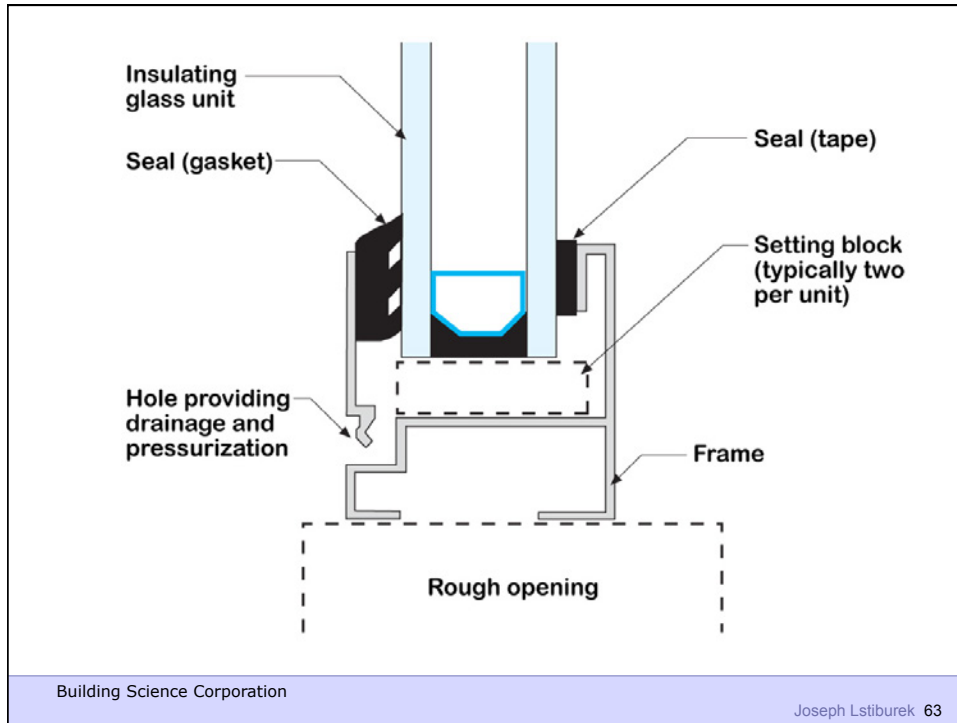

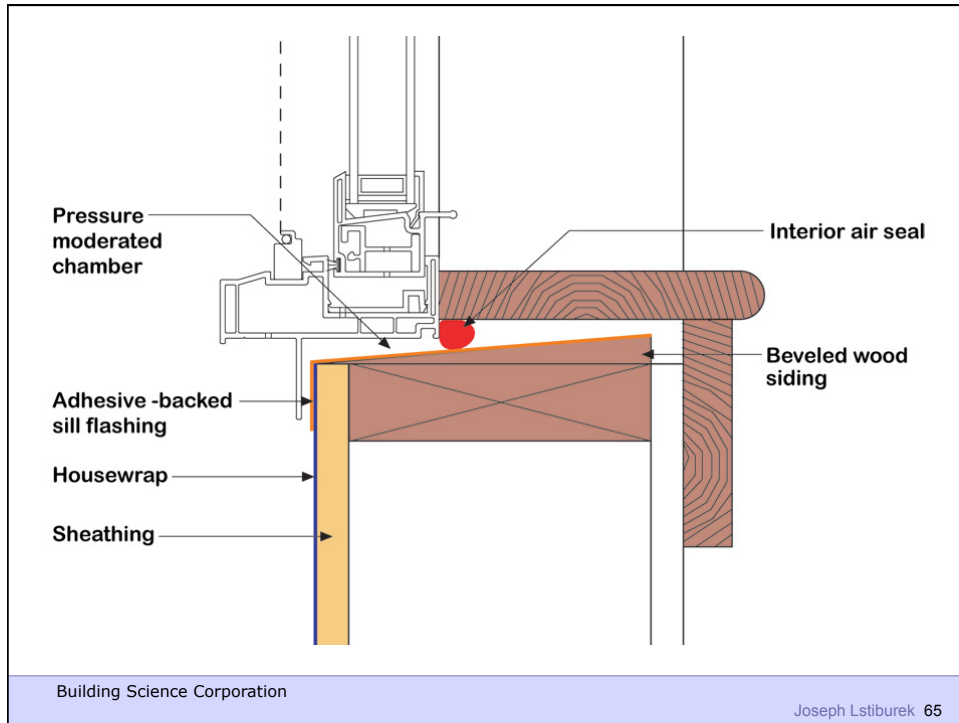



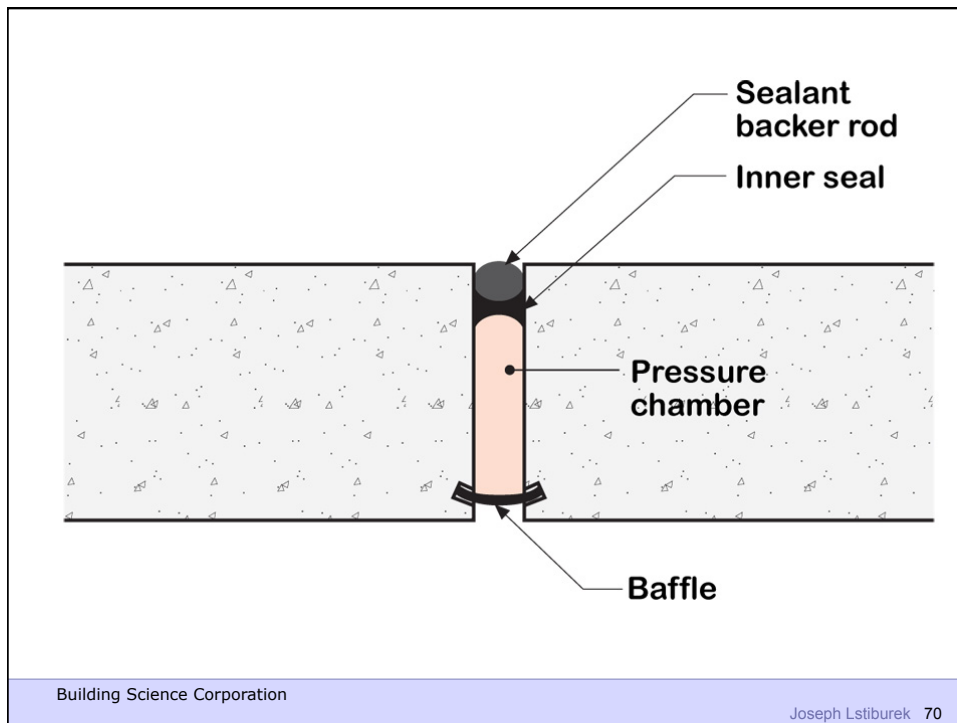
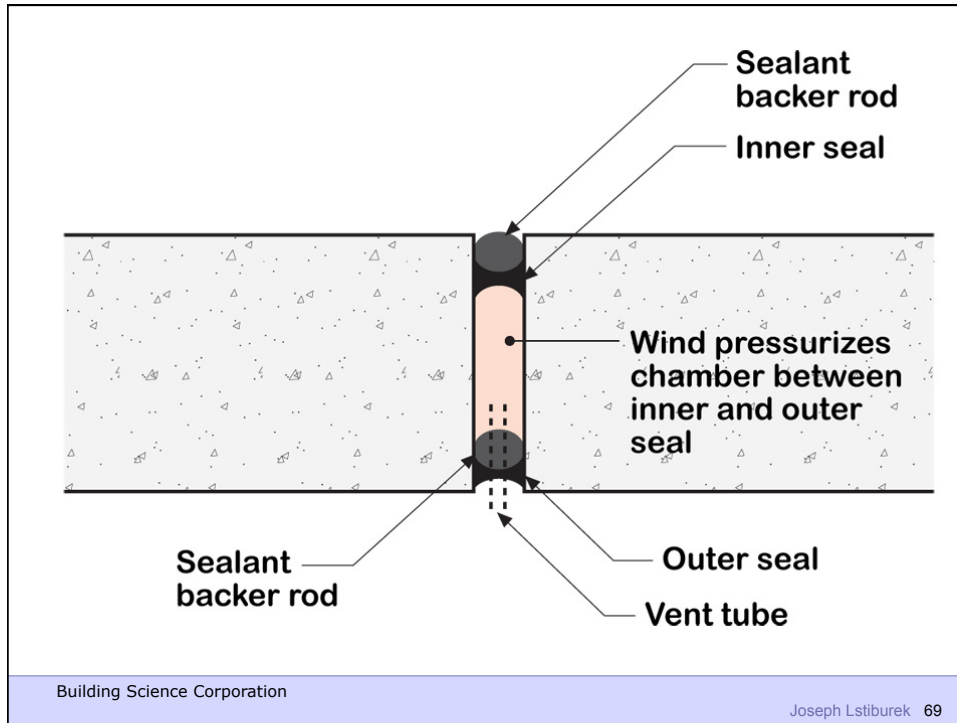

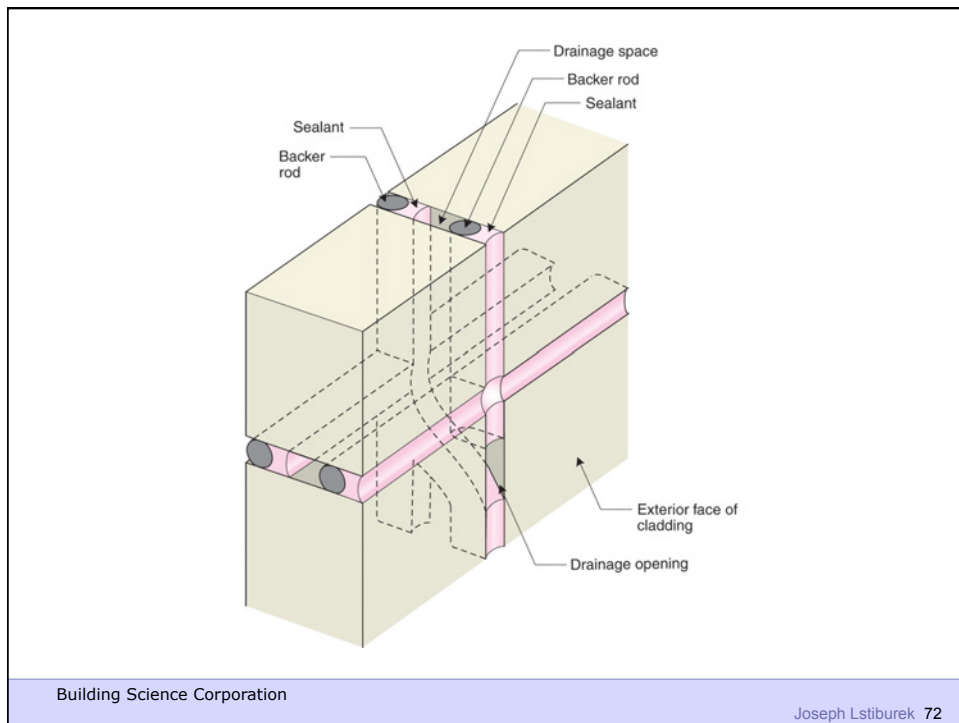
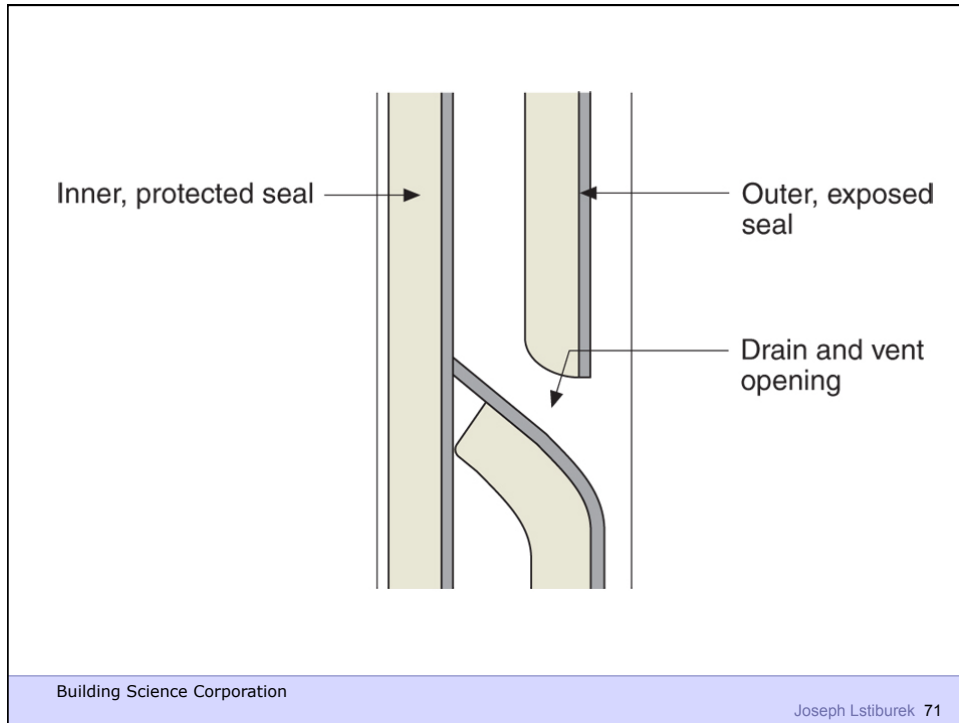



Building Science Corporation

Joseph Lstiburek 73



Building Science Corporation

Joseph Lstiburek 74







Building Science Corporation

Joseph Lstiburek 79



Building Science Corporation

Joseph Lstiburek 80



Building Science Corporation

Joseph Lstiburek 81

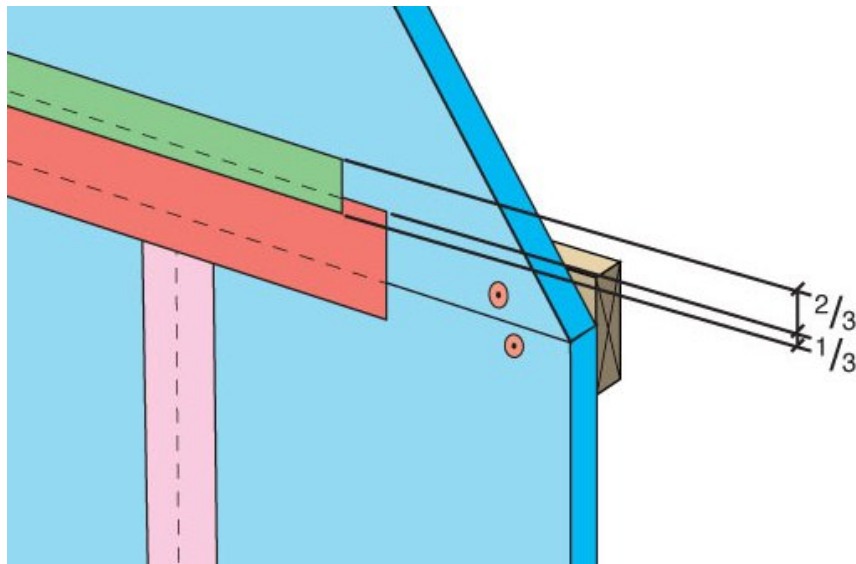

Building Science Corporation

Joseph Lstiburek 82

