

Joseph Lstiburek, Ph.D., P.Eng., ASHRAE Fellow

# Building Science

Adventures In Building Science  
EPS Expo 2015

presented by [www.buildingscience.com](http://www.buildingscience.com)

## Walls and Rain and Windows

Building Science Corporation

Joseph Lstiburek 2

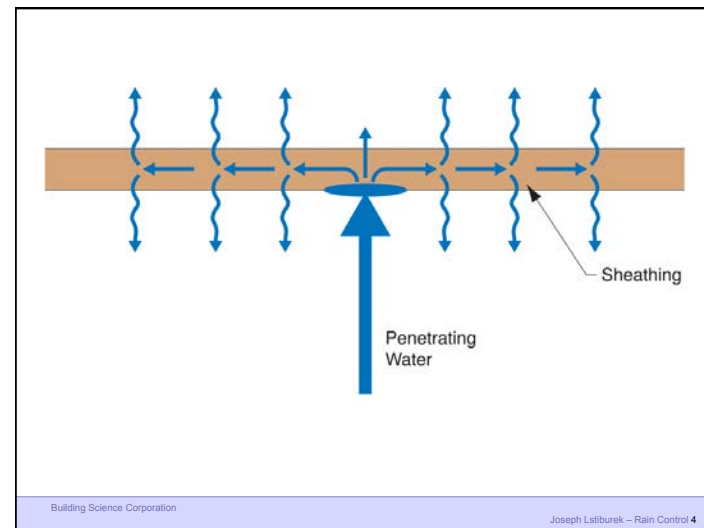
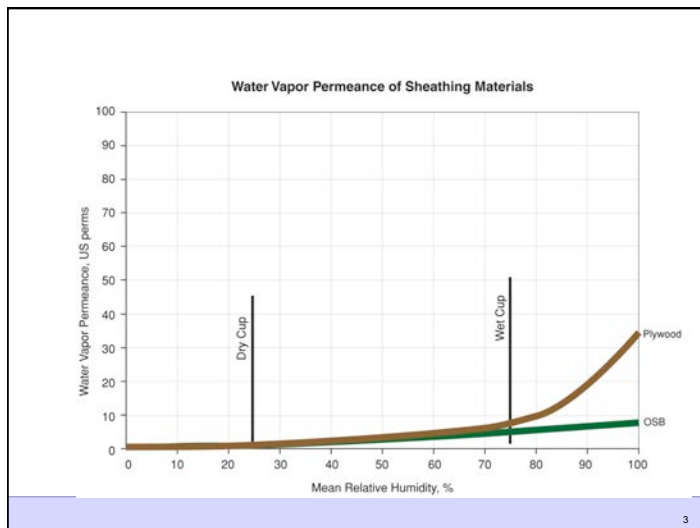

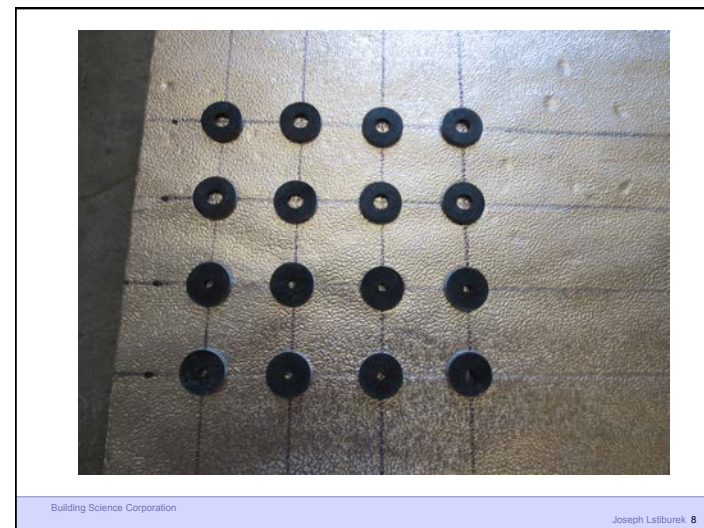
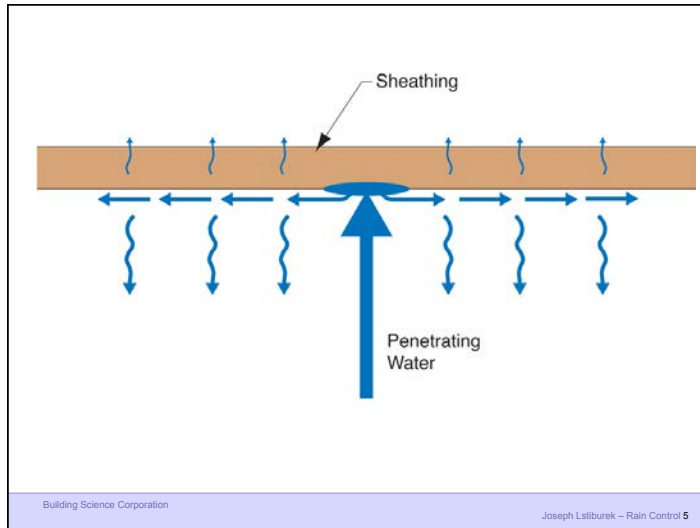

Beer Screen?

Building Science Corporation Joseph Lstiburek 9

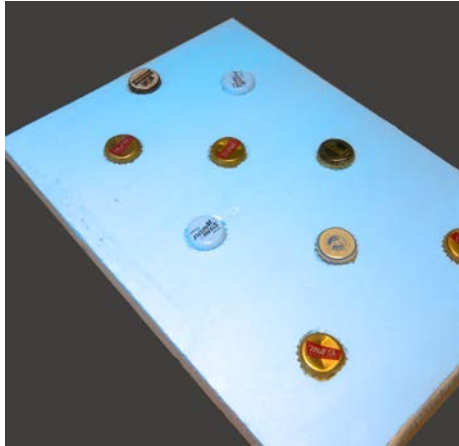

Building Science Corporation Joseph Lstiburek 10



Building Science Corporation Joseph Lstiburek 11



Building Science Corporation Joseph Lstiburek 12

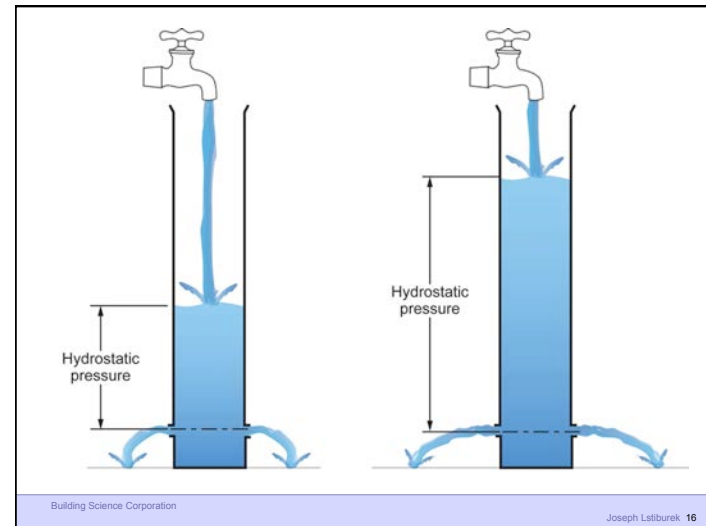
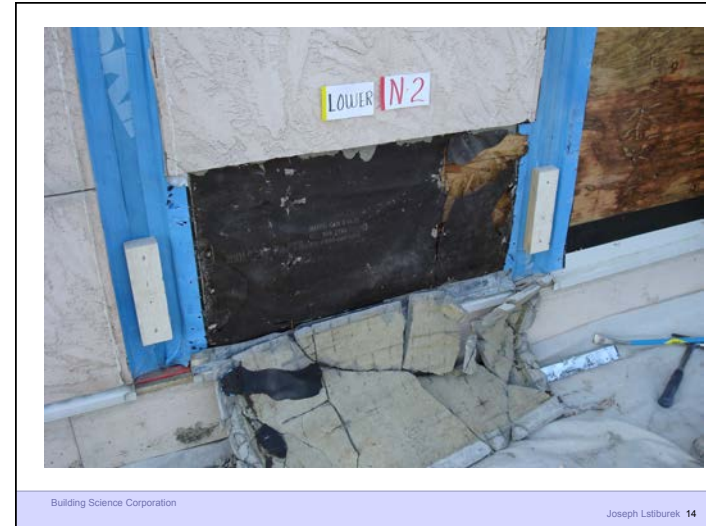
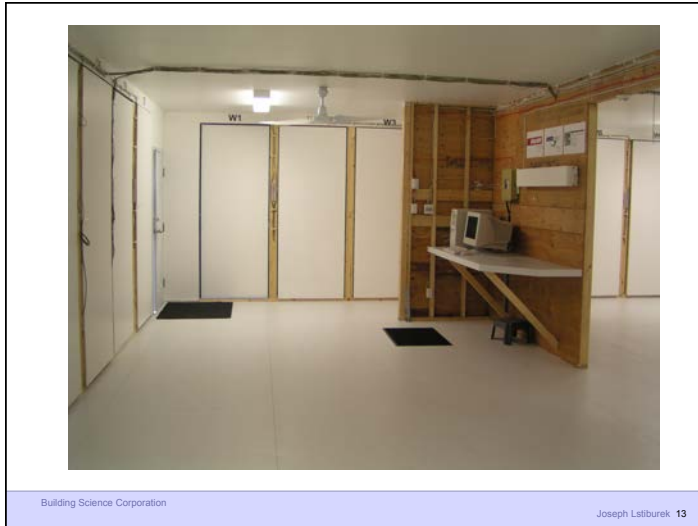

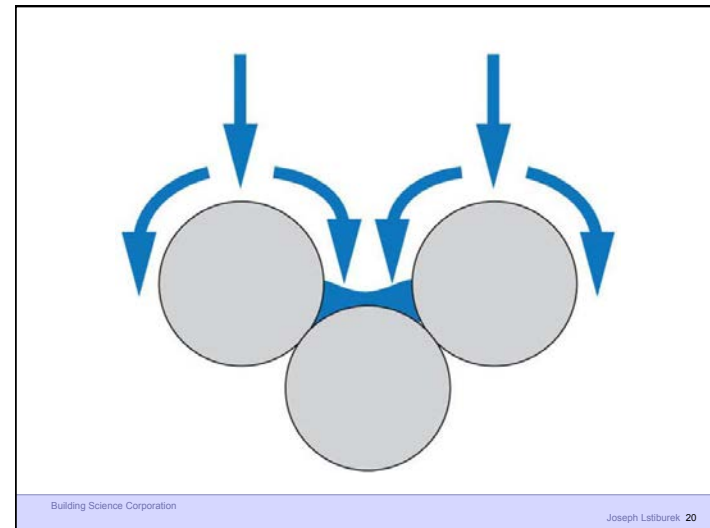
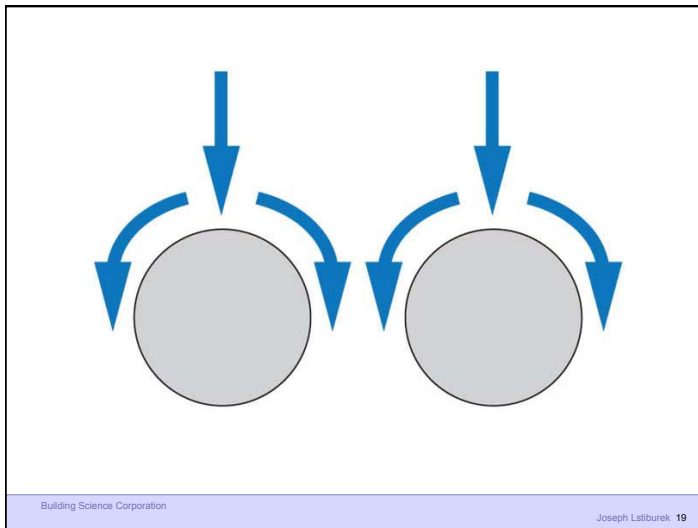
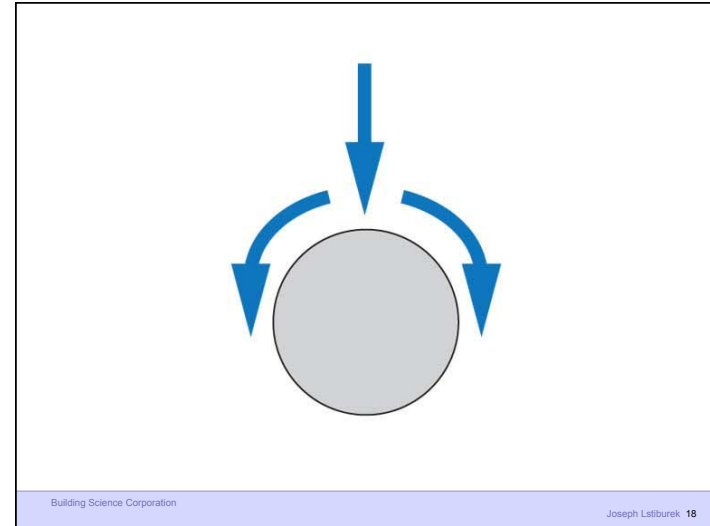
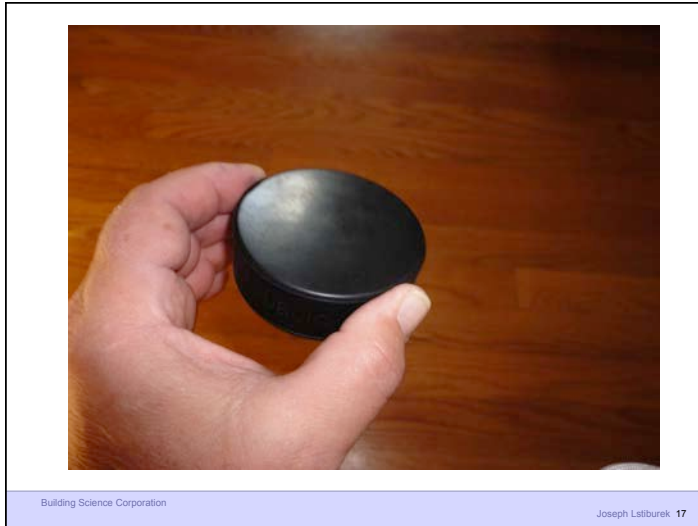

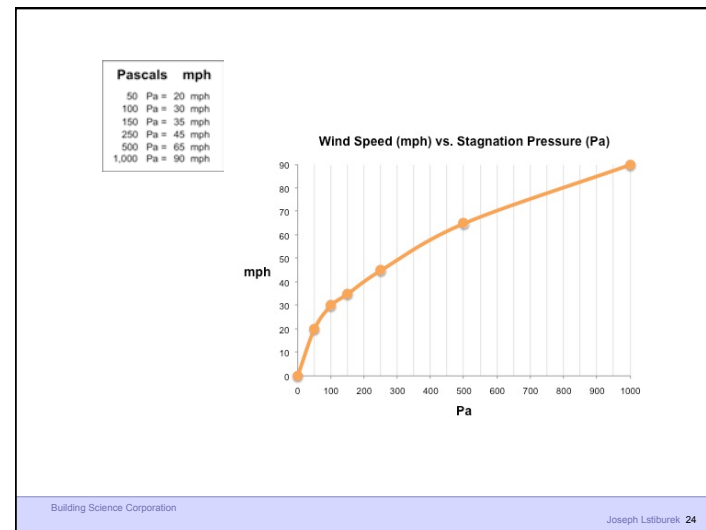
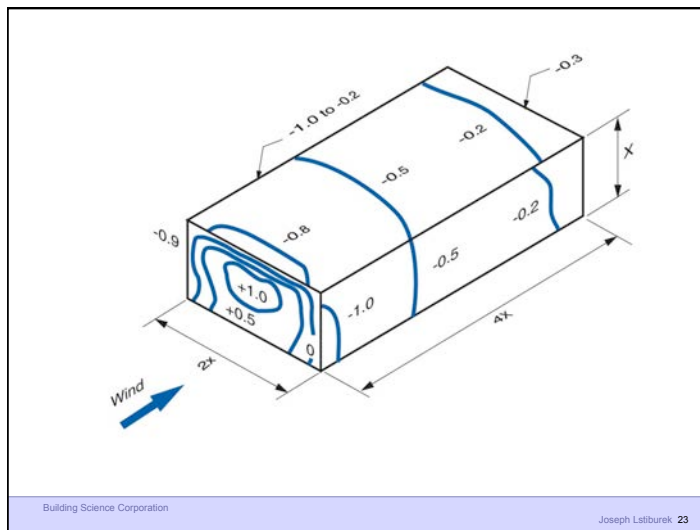
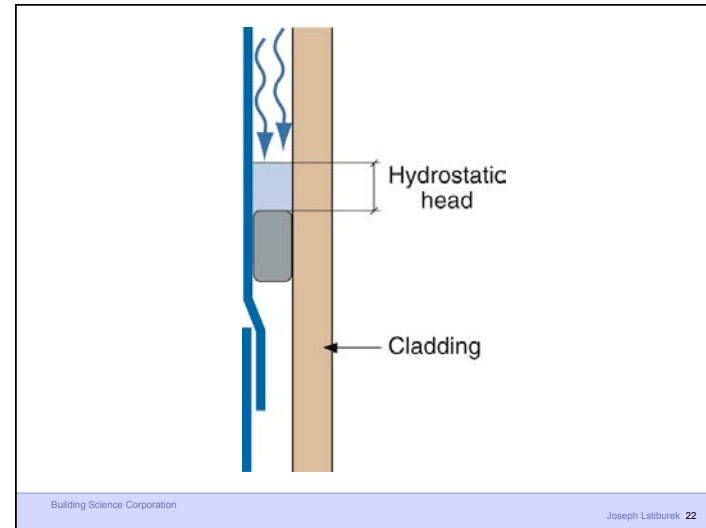
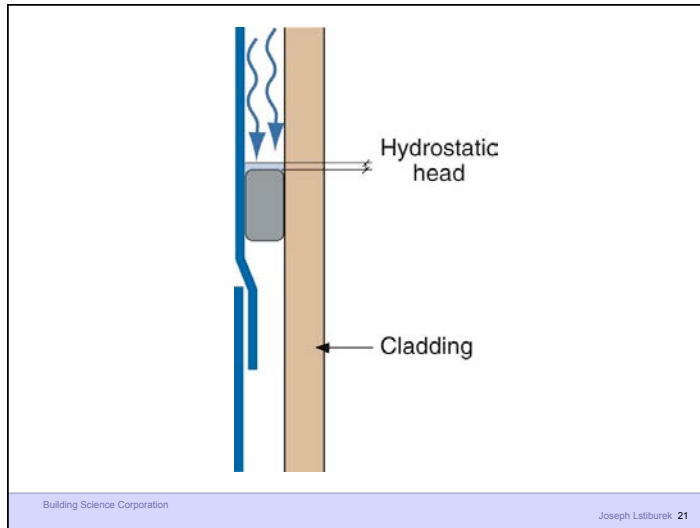



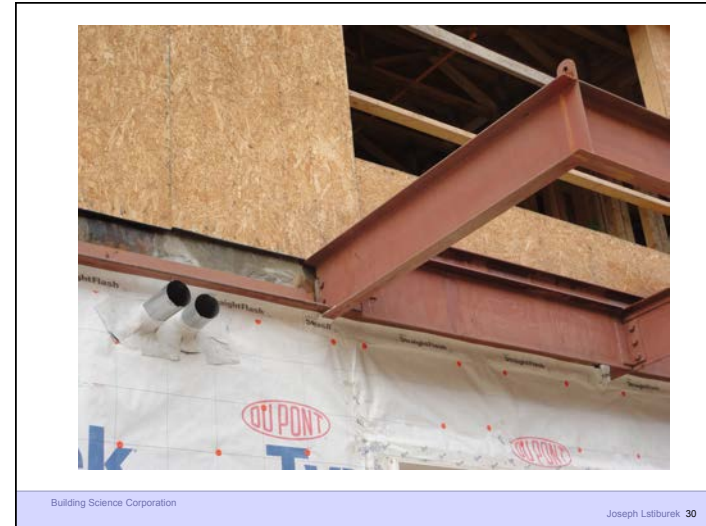
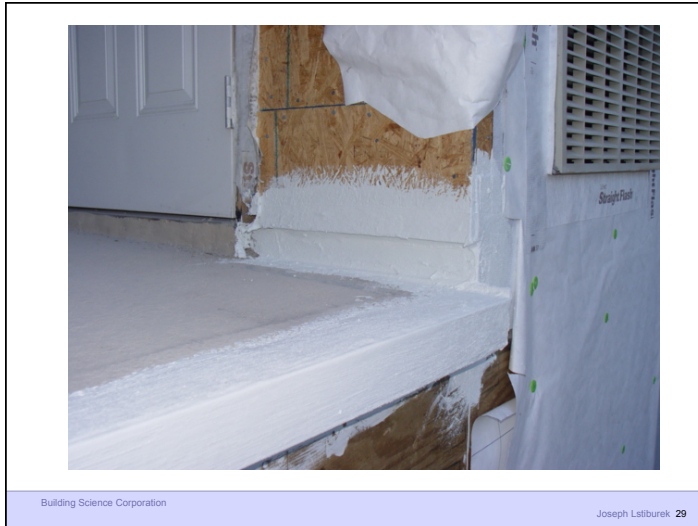



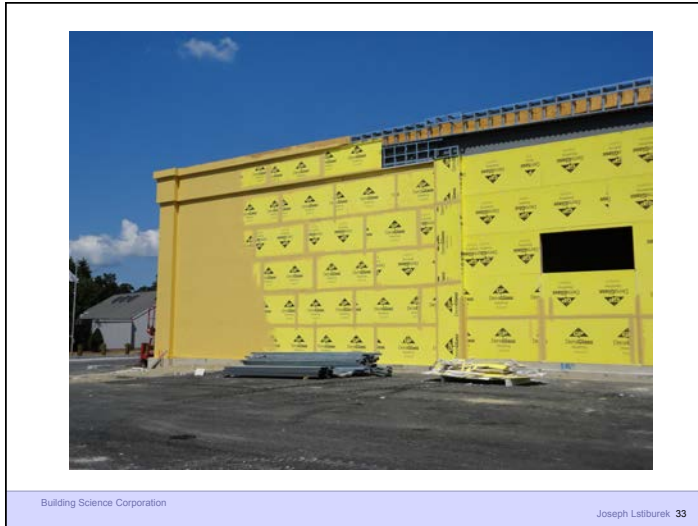

Windows and Punched Openings

Building Science Corporation  
Joseph Lstiburek 35

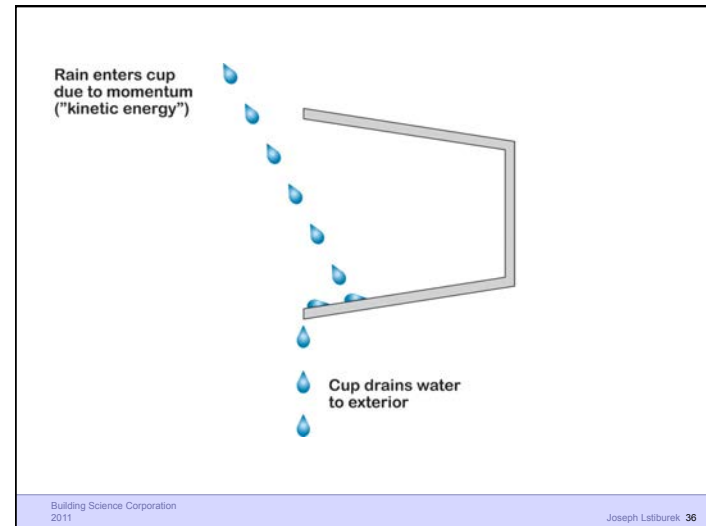

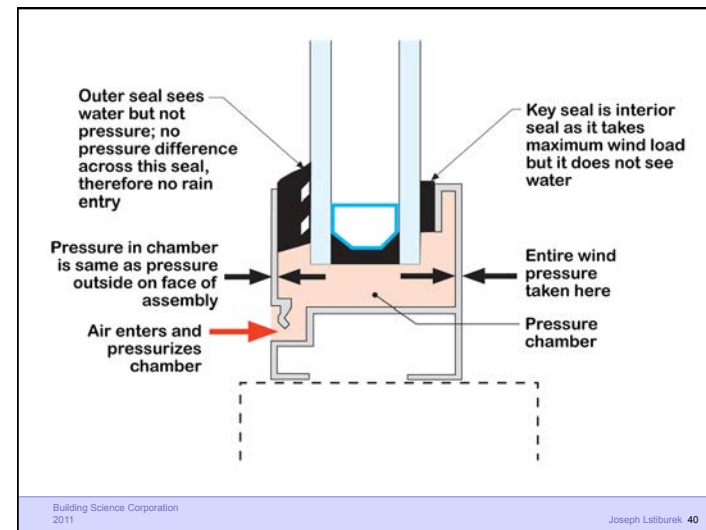
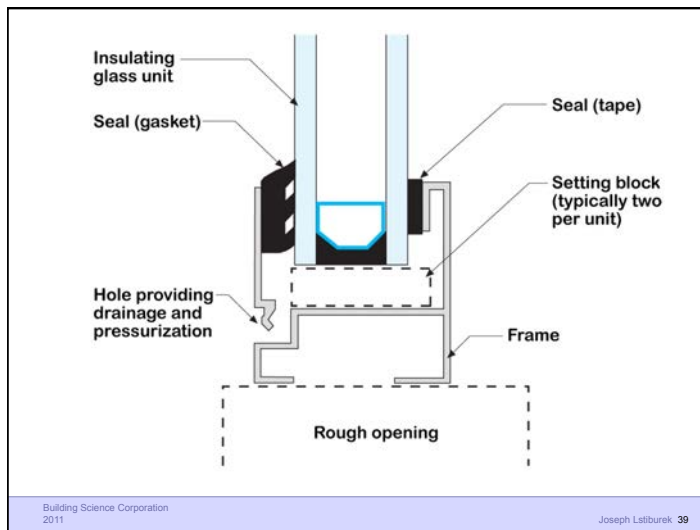
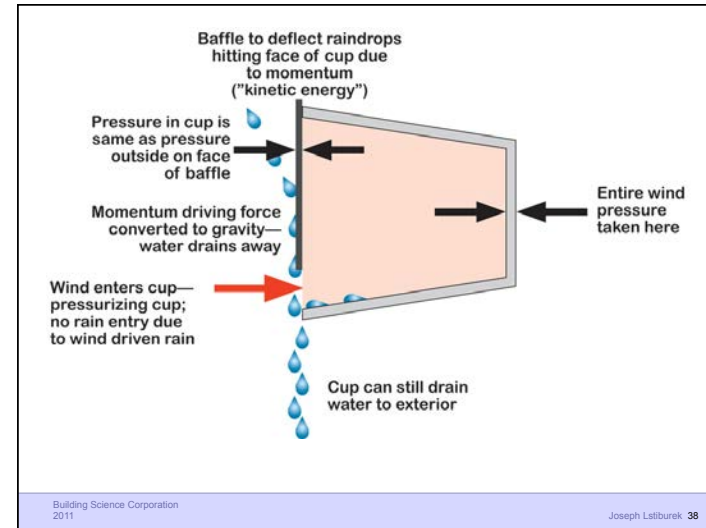
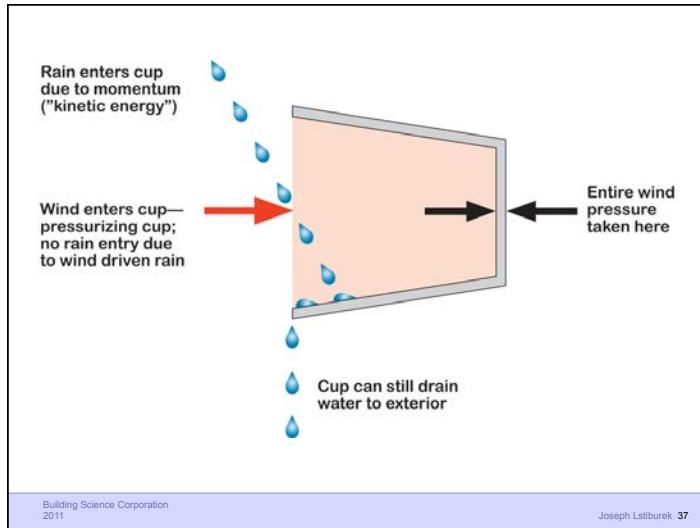

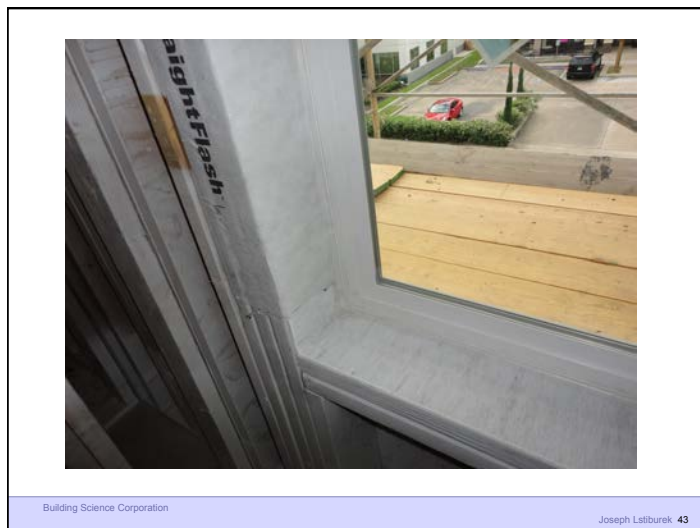
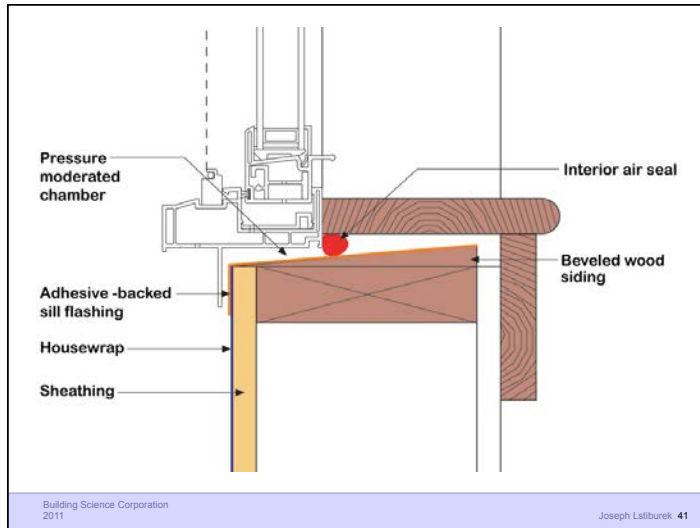

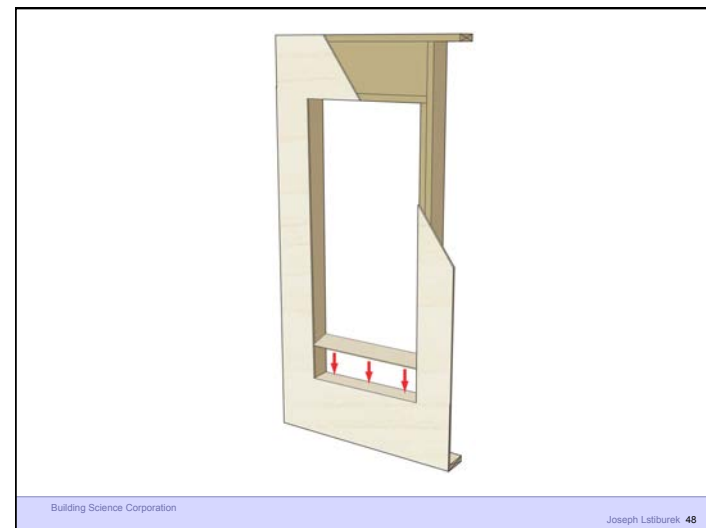
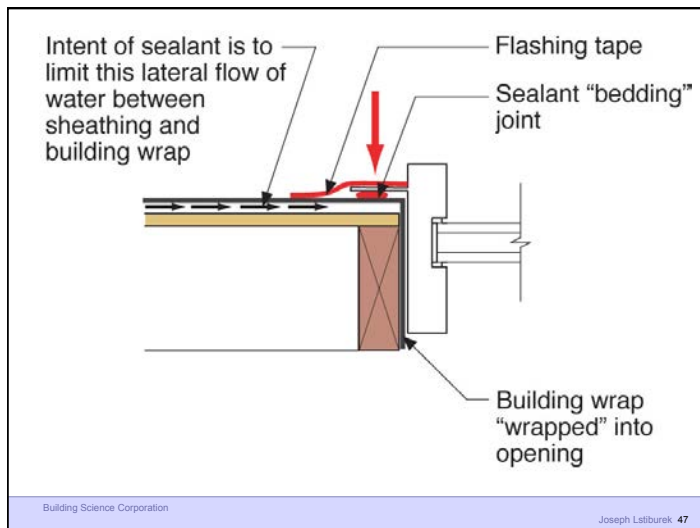

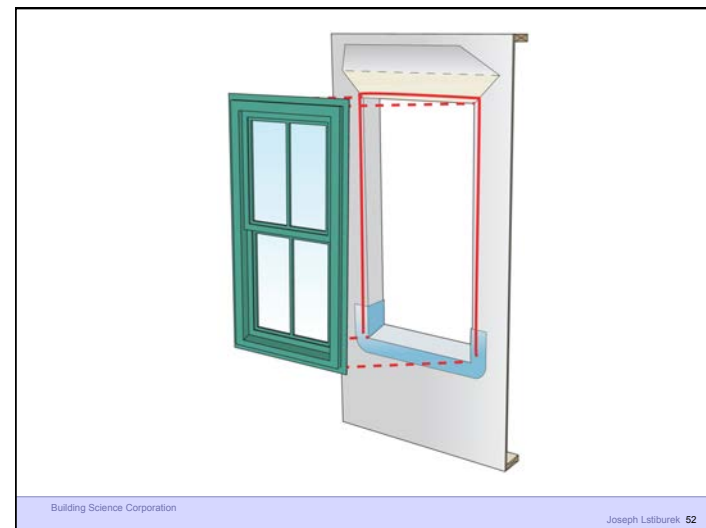
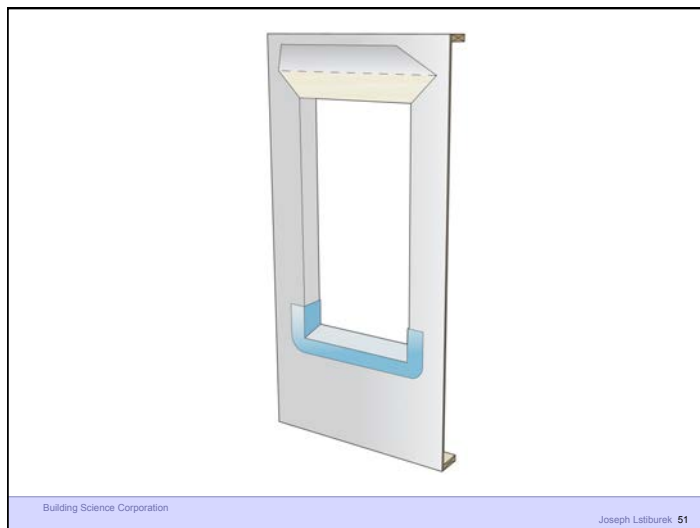
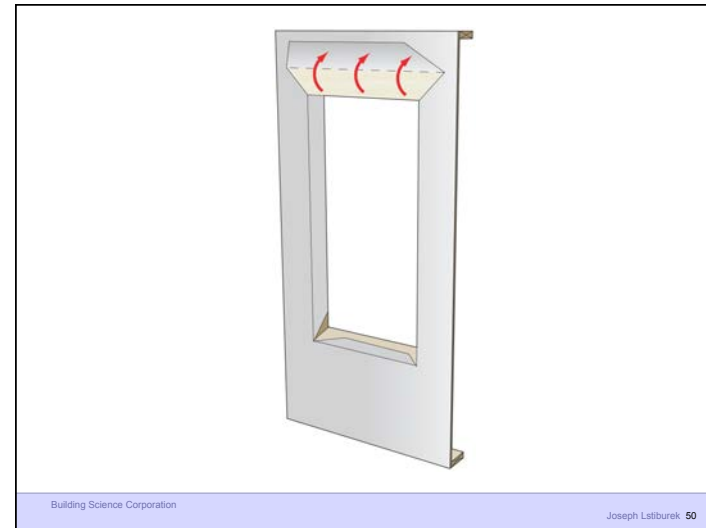
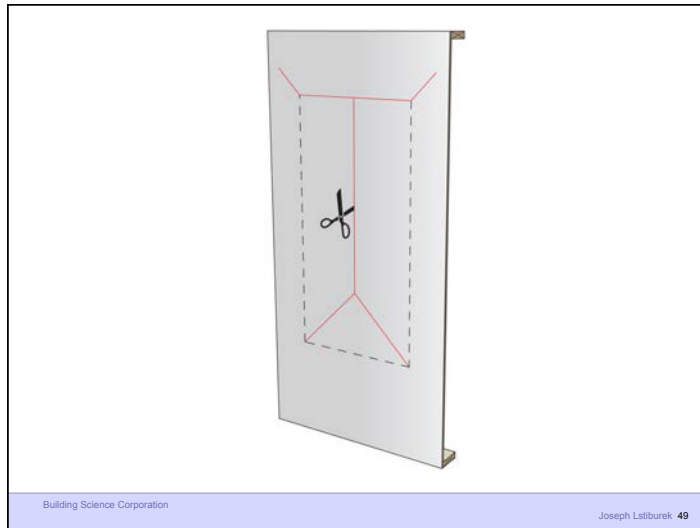

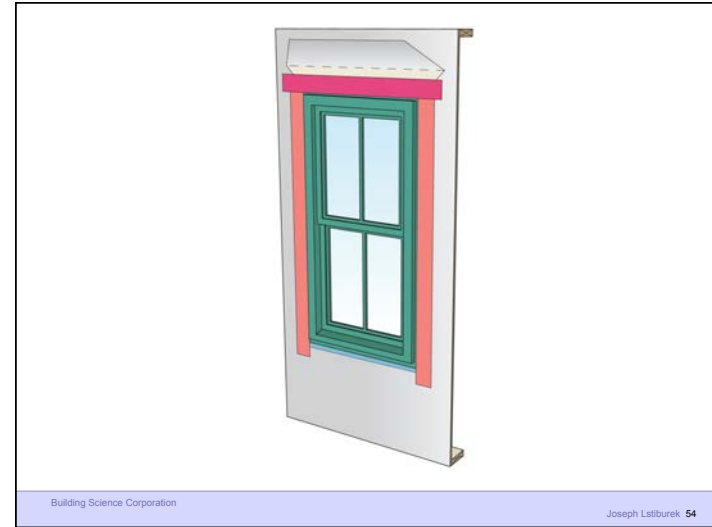
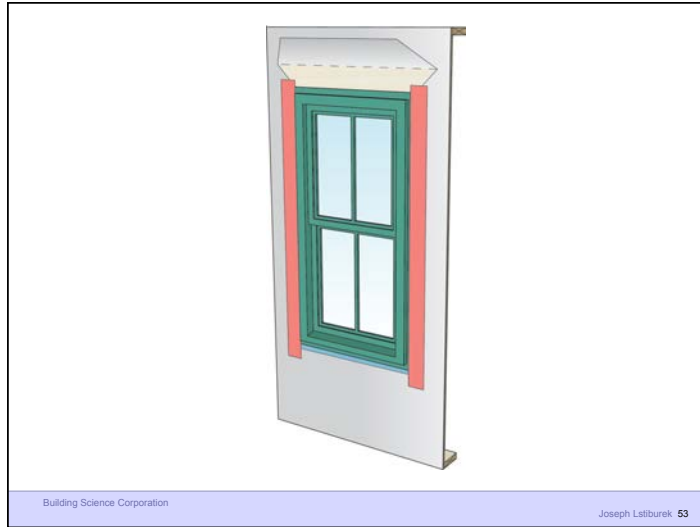

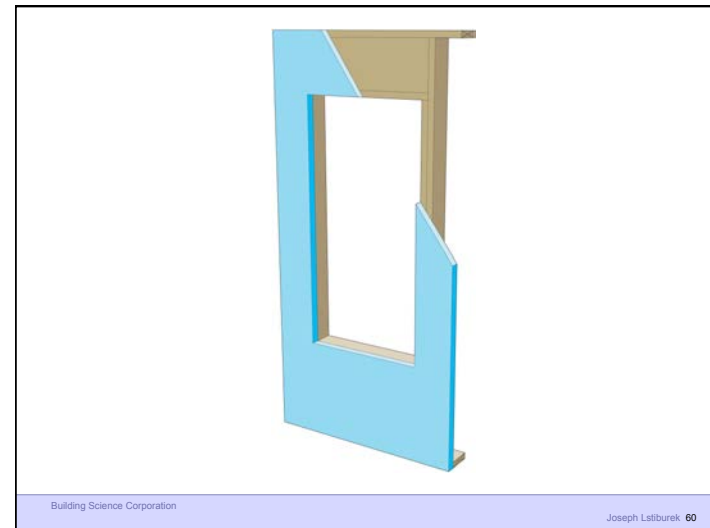
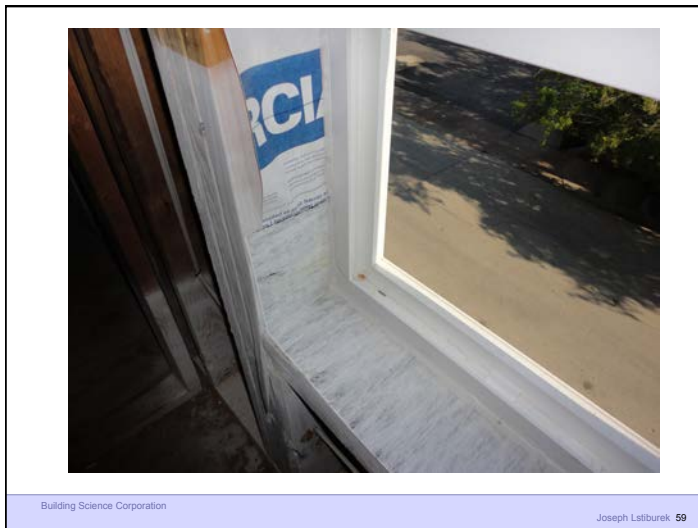
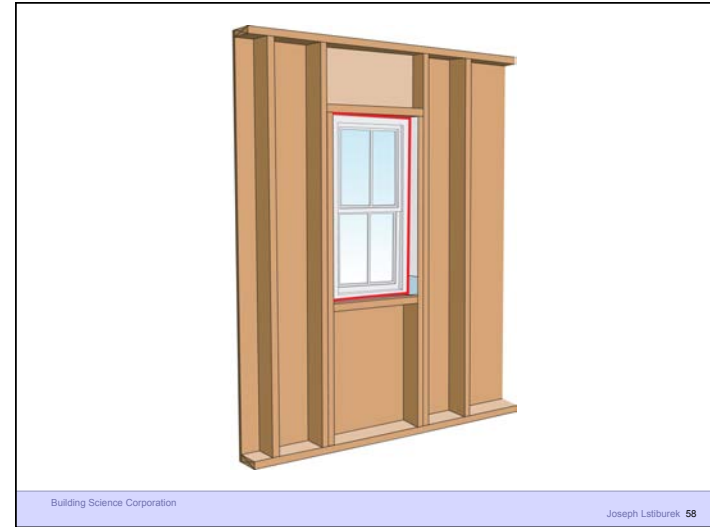
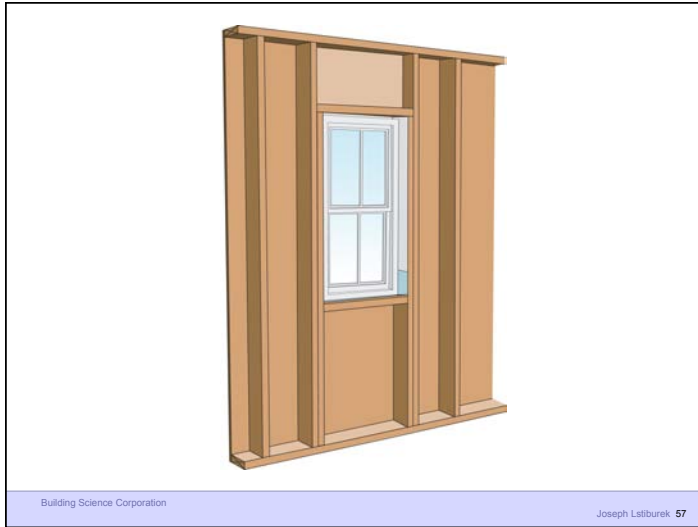

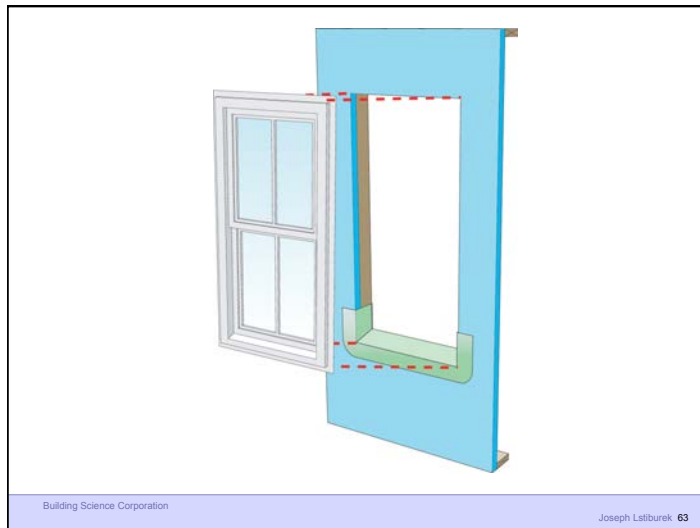
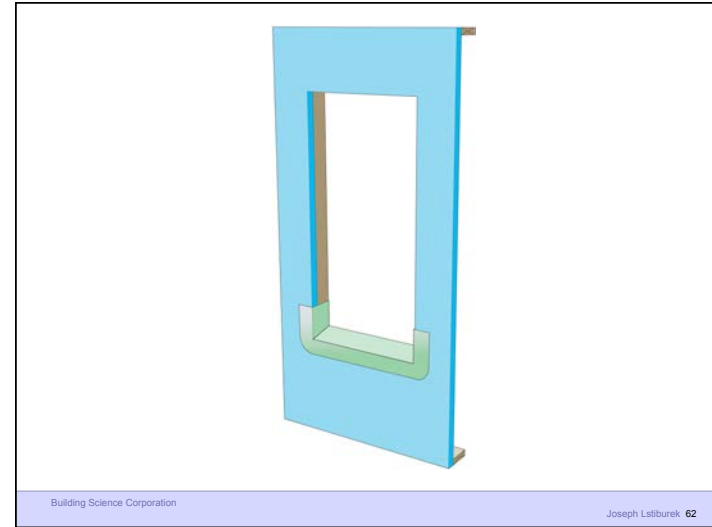
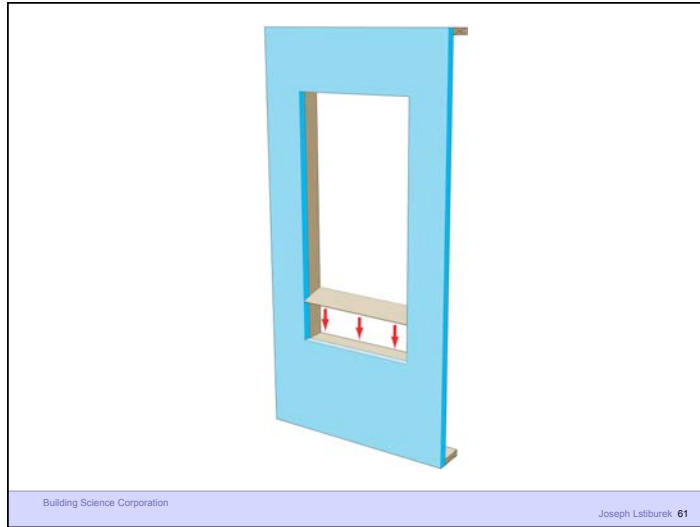



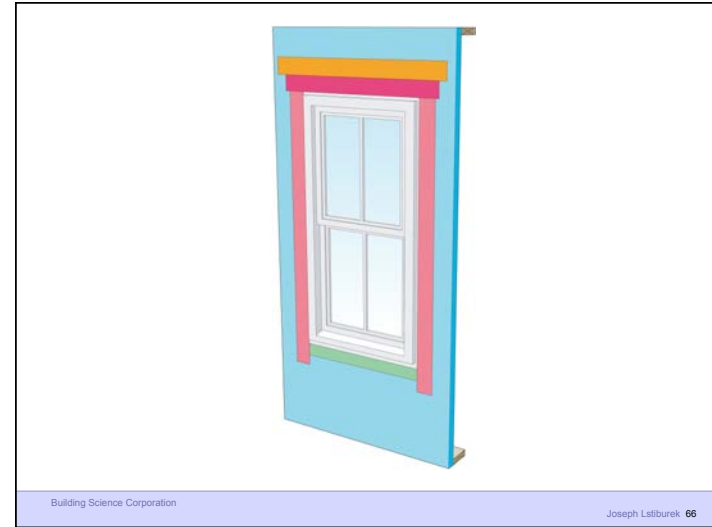
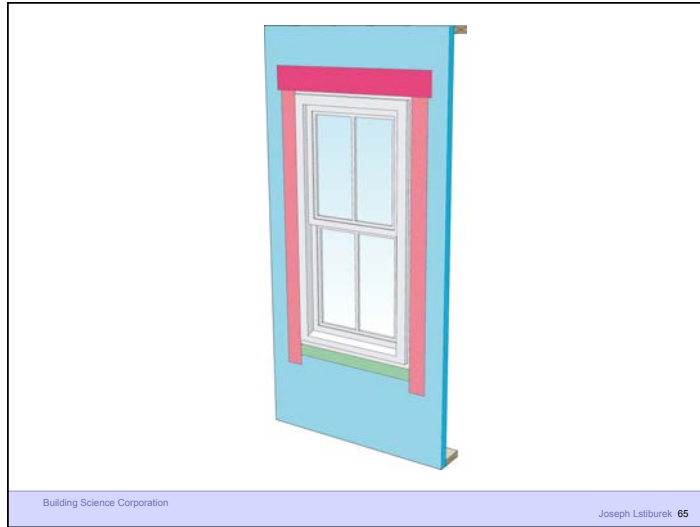

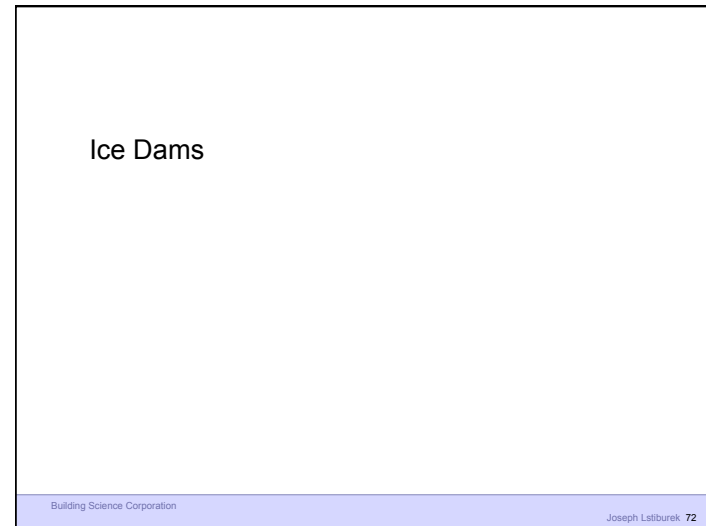

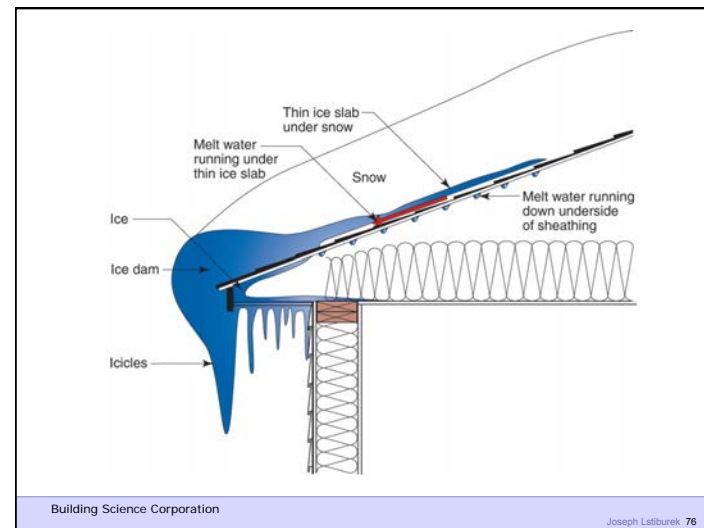
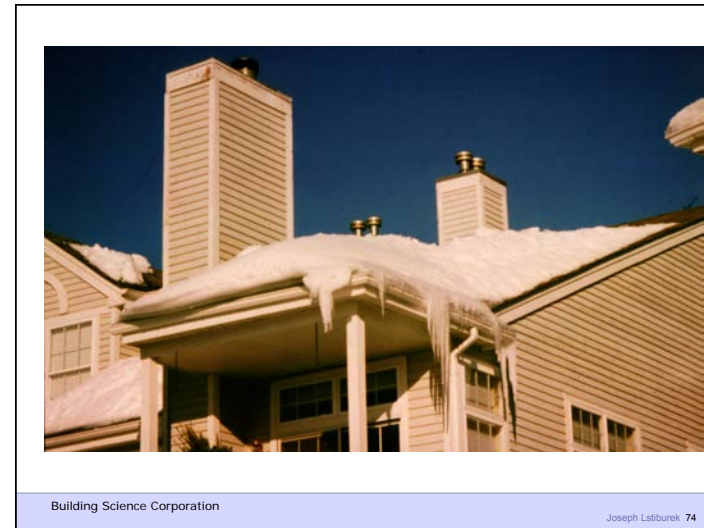
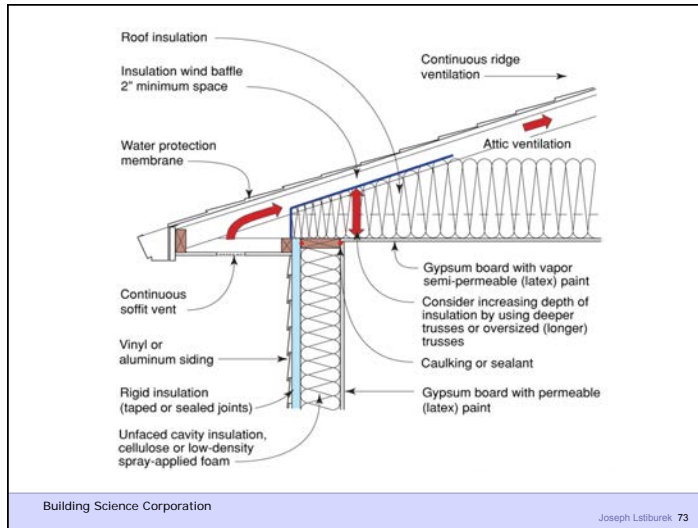

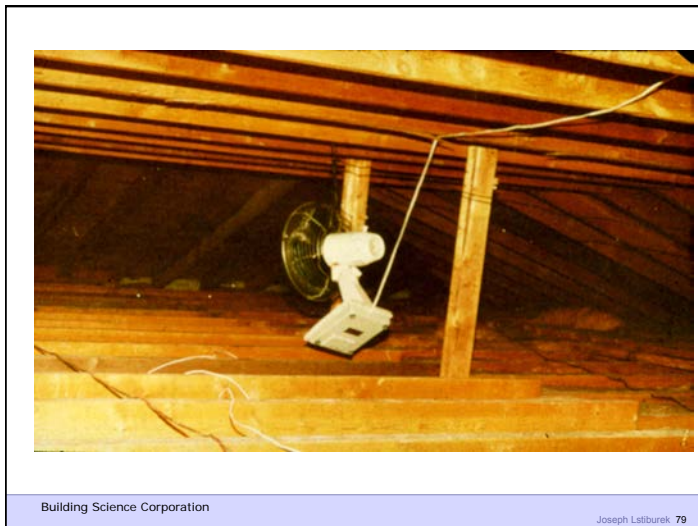
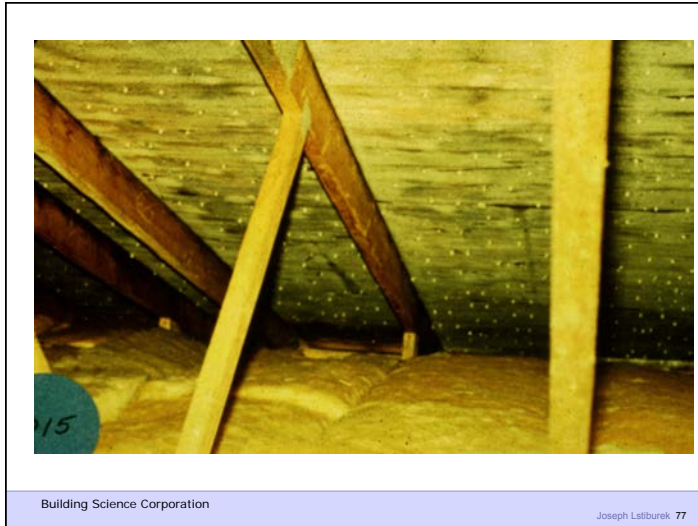

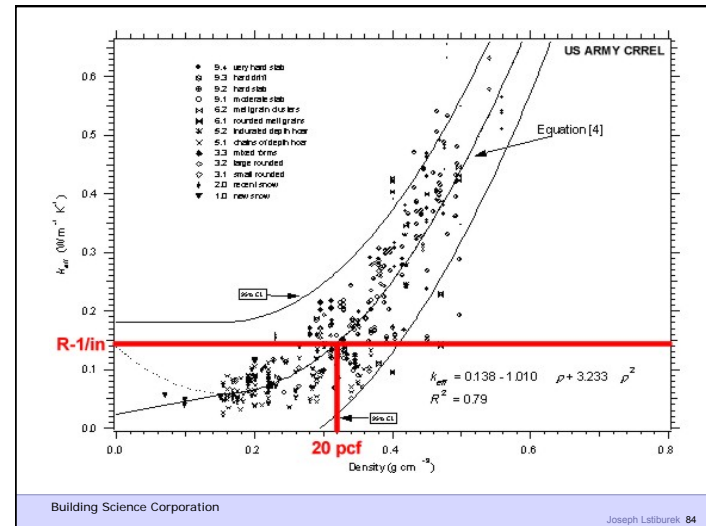
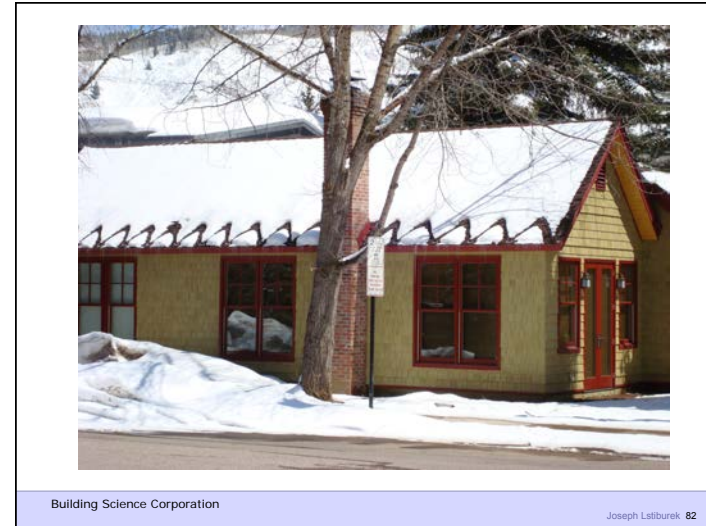

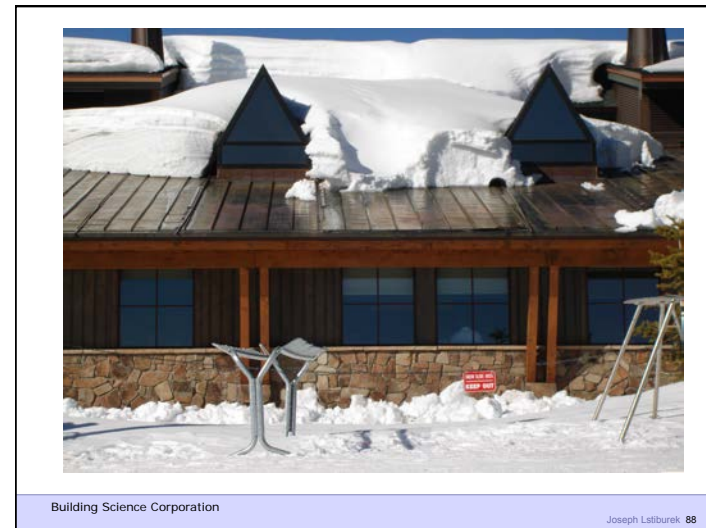
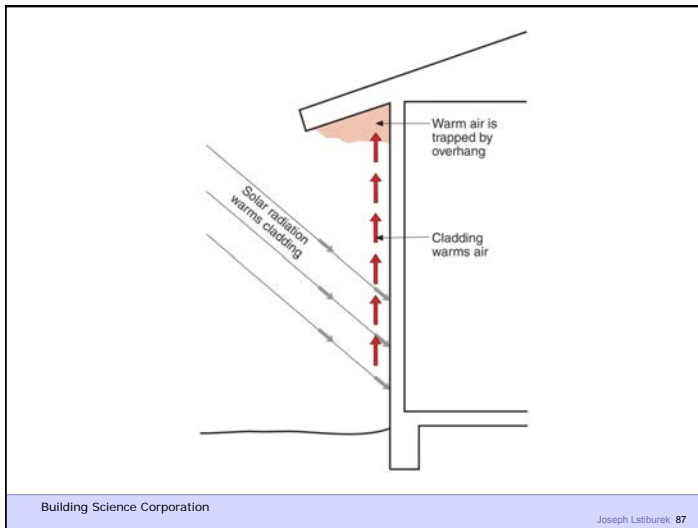
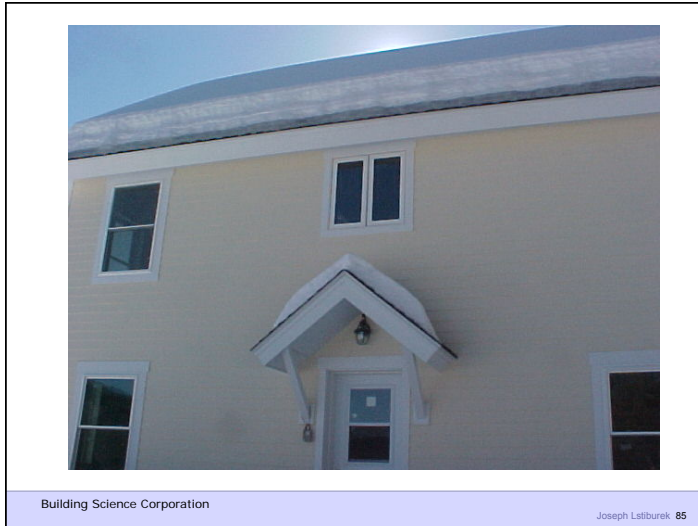

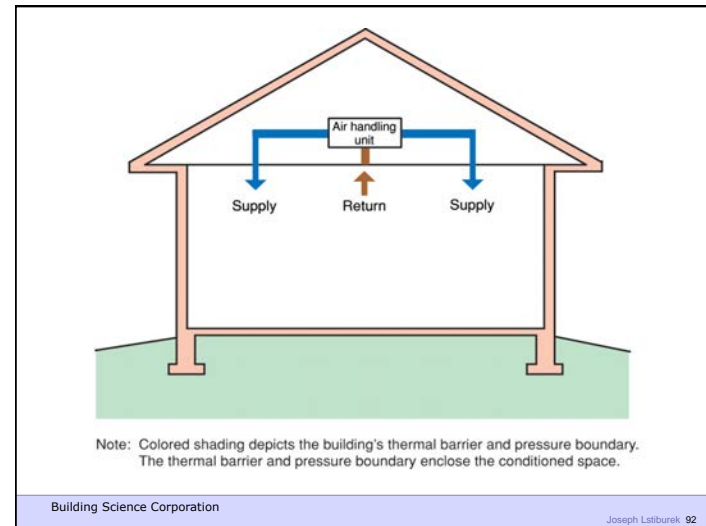
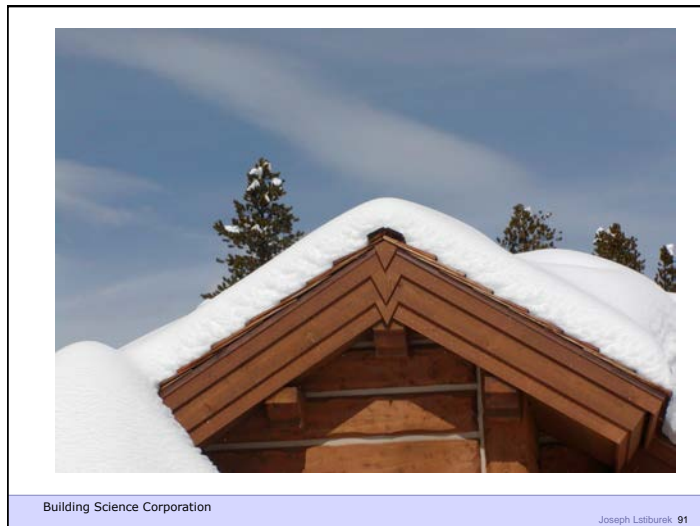

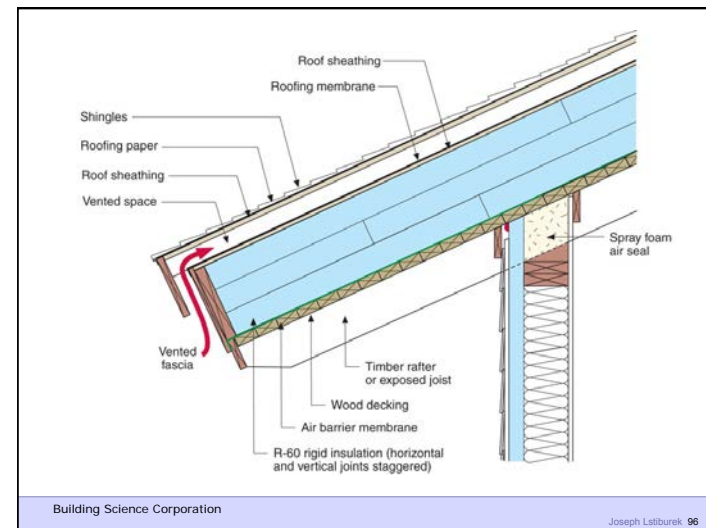
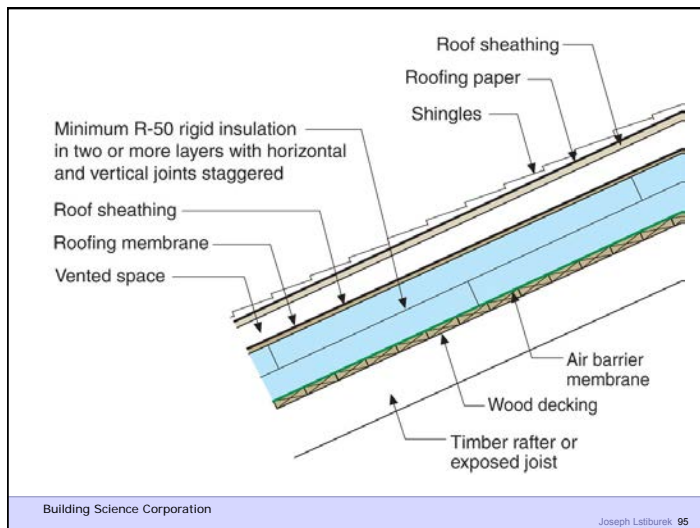
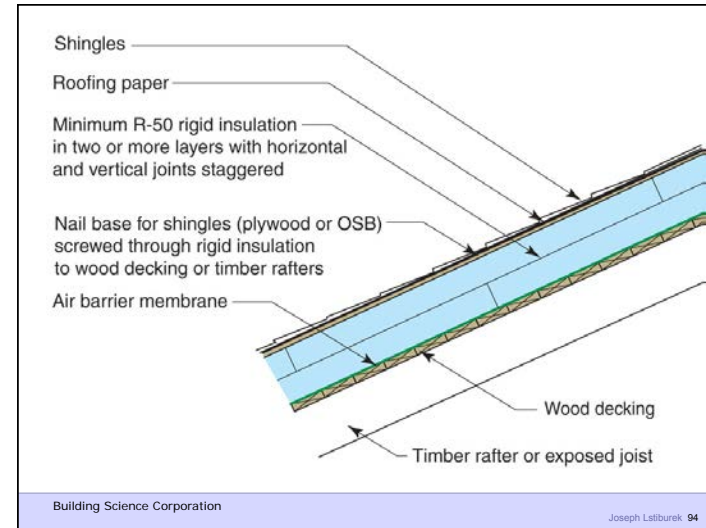
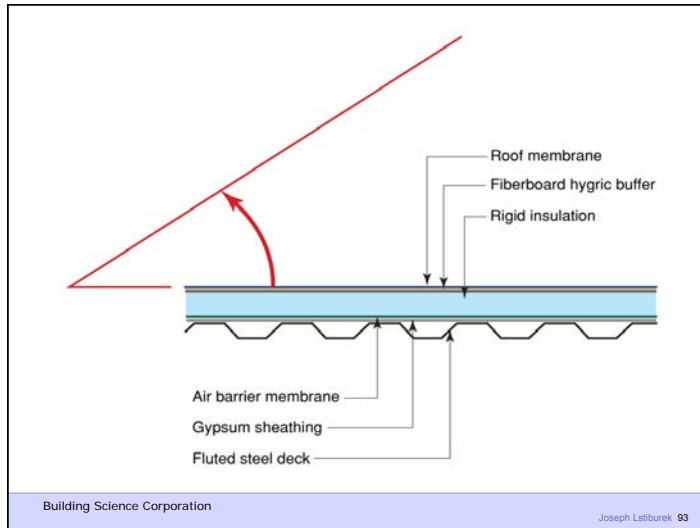



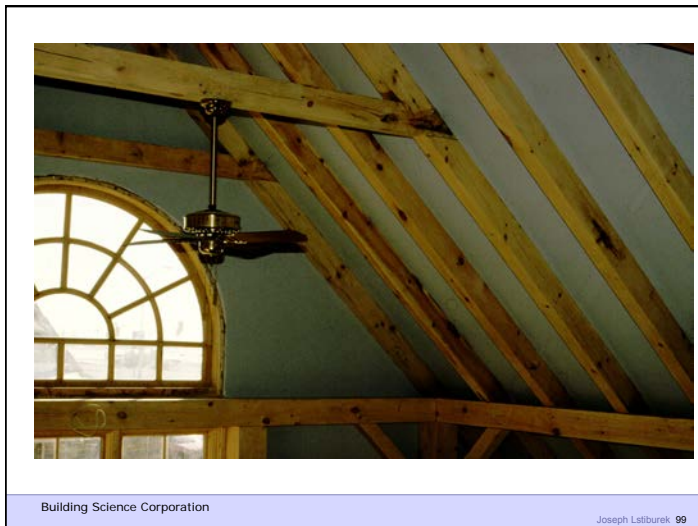
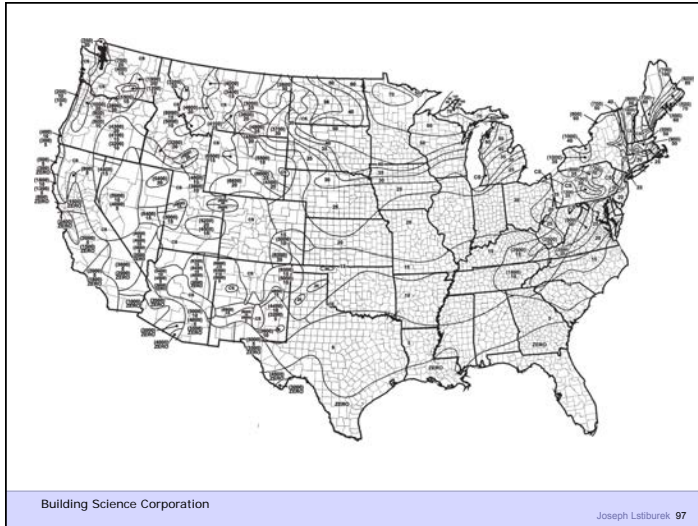



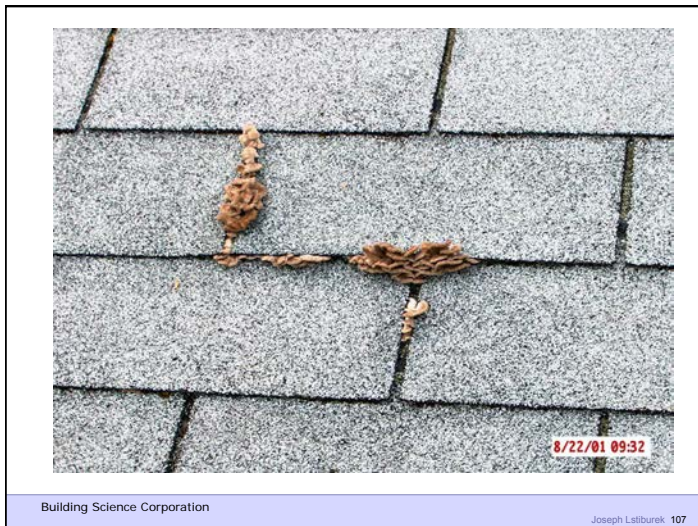
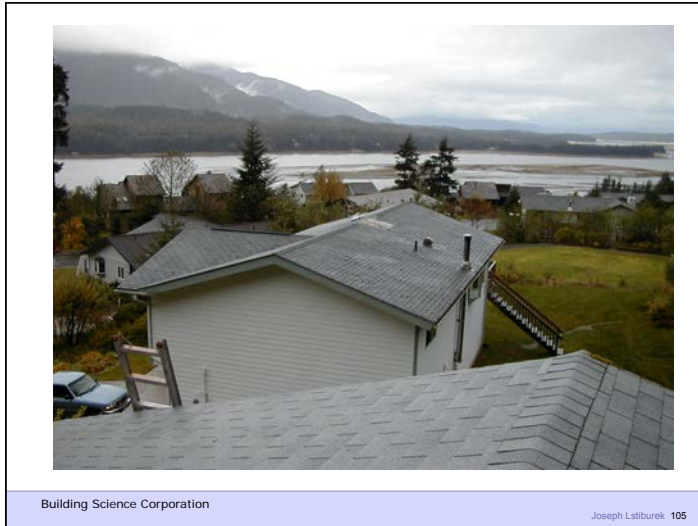



Building Science Corporation

Joseph Lstiburek 109

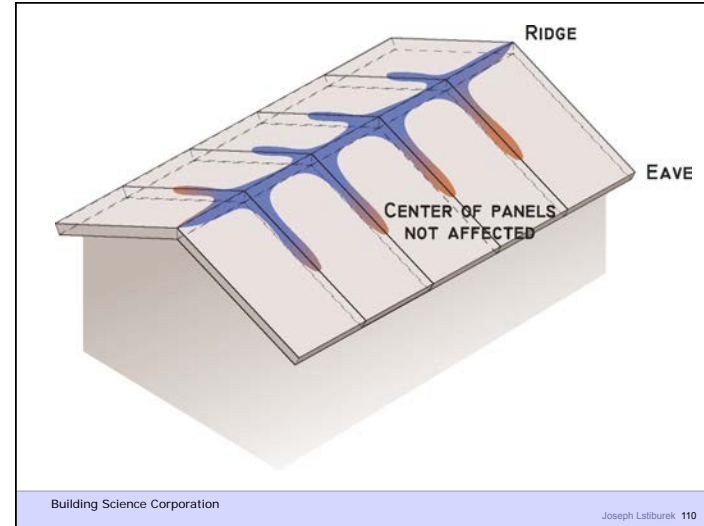

Building Science Corporation

Joseph Lstiburek 110



Building Science Corporation

Joseph Lstiburek 111

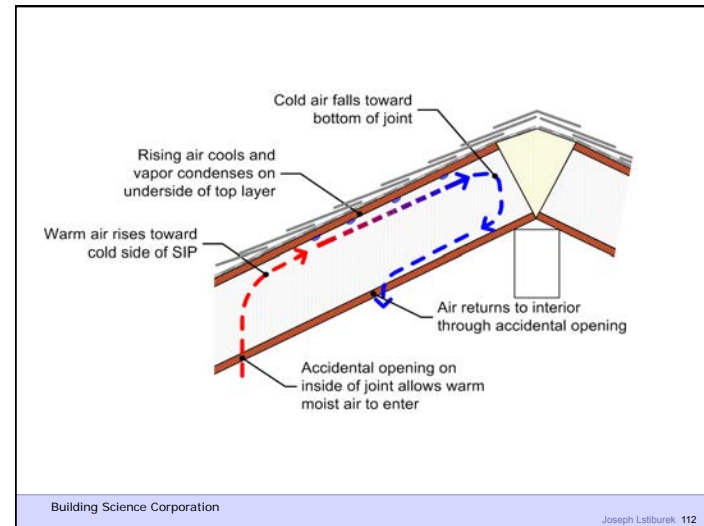

Building Science Corporation

Joseph Lstiburek 112

