

Joseph Lstiburek, Ph.D., P.Eng, ASHRAE Fellow

Building Science

Adventures In Building Science

www.buildingscience.com

Arrhenius Equation

For Every 10 Degree K Rise
Activation Energy Doubles

$$k = Ae^{-E_a/(RT)}$$

Damage Functions

Water

Heat

Ultra-violet Radiation

2nd Law of Thermodynamics

Heat Flow Is From Warm To Cold

Moisture Flow Is From Warm To Cold

Moisture Flow Is From More To Less

Air Flow Is From A Higher Pressure to a
Lower Pressure

Gravity Acts Down





Exposure

Extreme	Over 60"
High	40" - 60"
Moderate	20" - 40"
Low	Under 20"

Water Control Layer

Air Control Layer

Vapor Control Layer

Thermal Control Layer

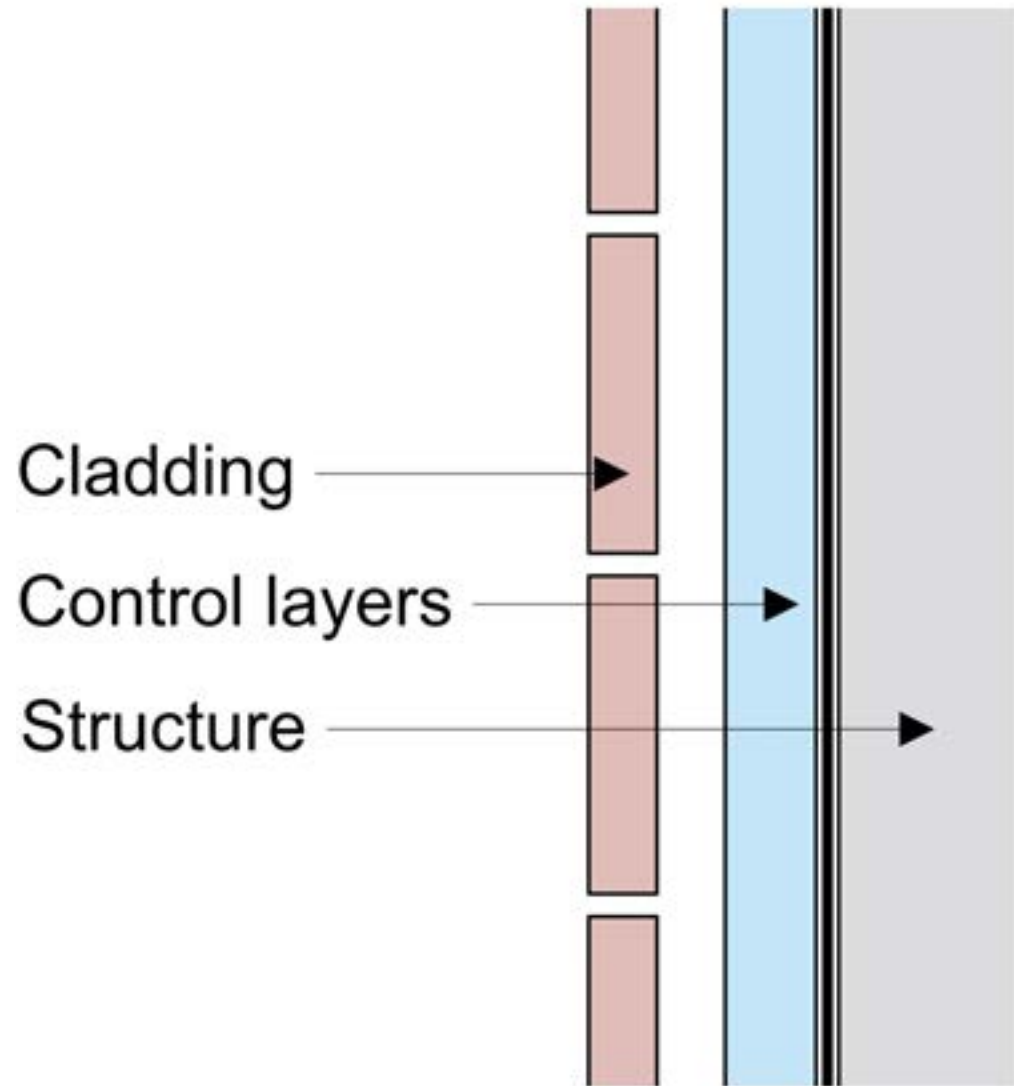

Wall

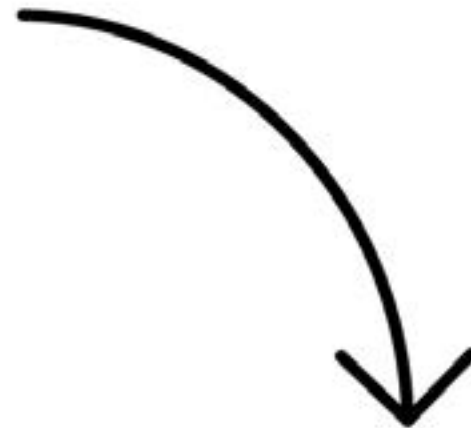
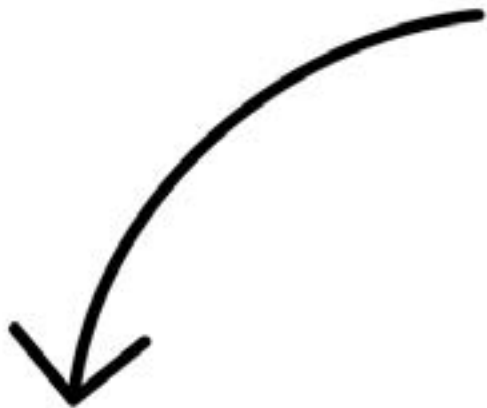

Slab



Roof

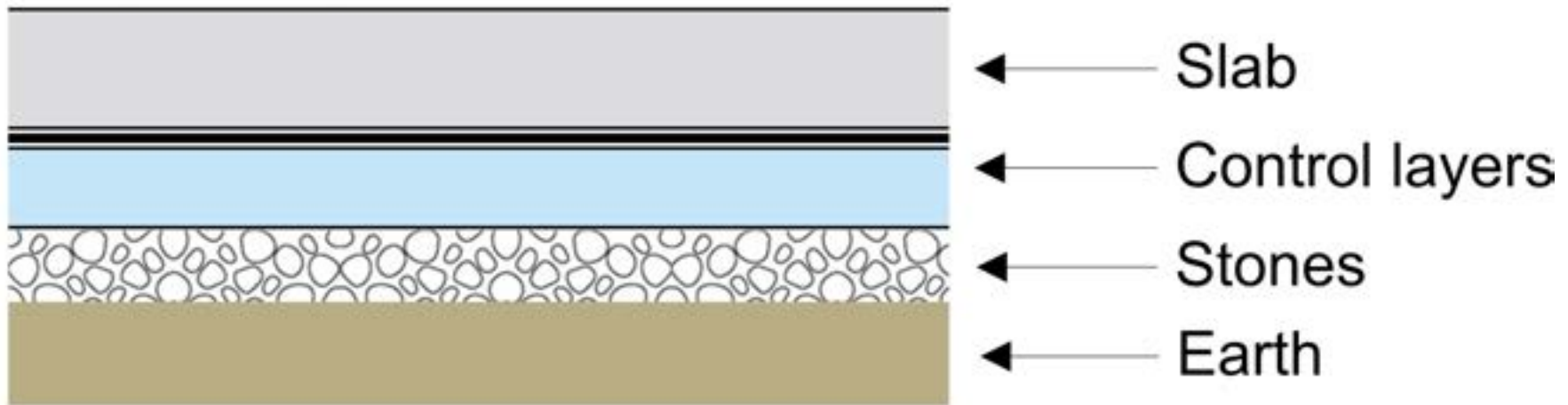

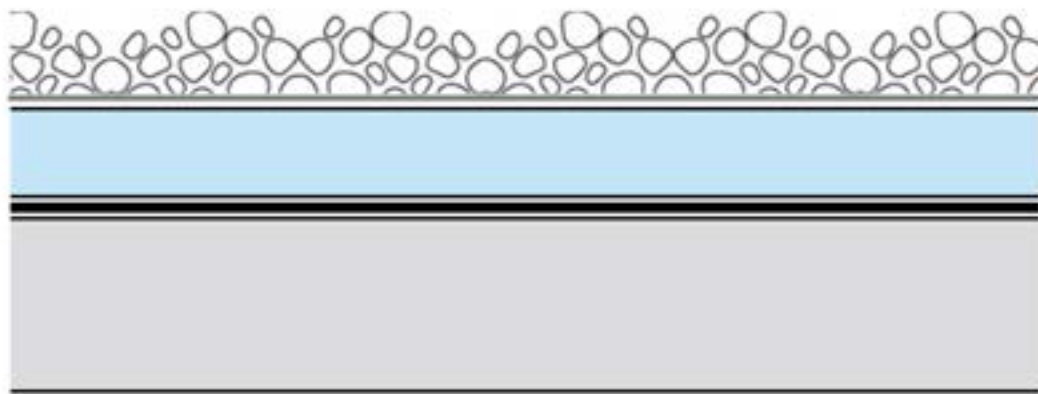

- ← Ballast
- ← Filter fabric
- ← Control layers
- ← Roof structure



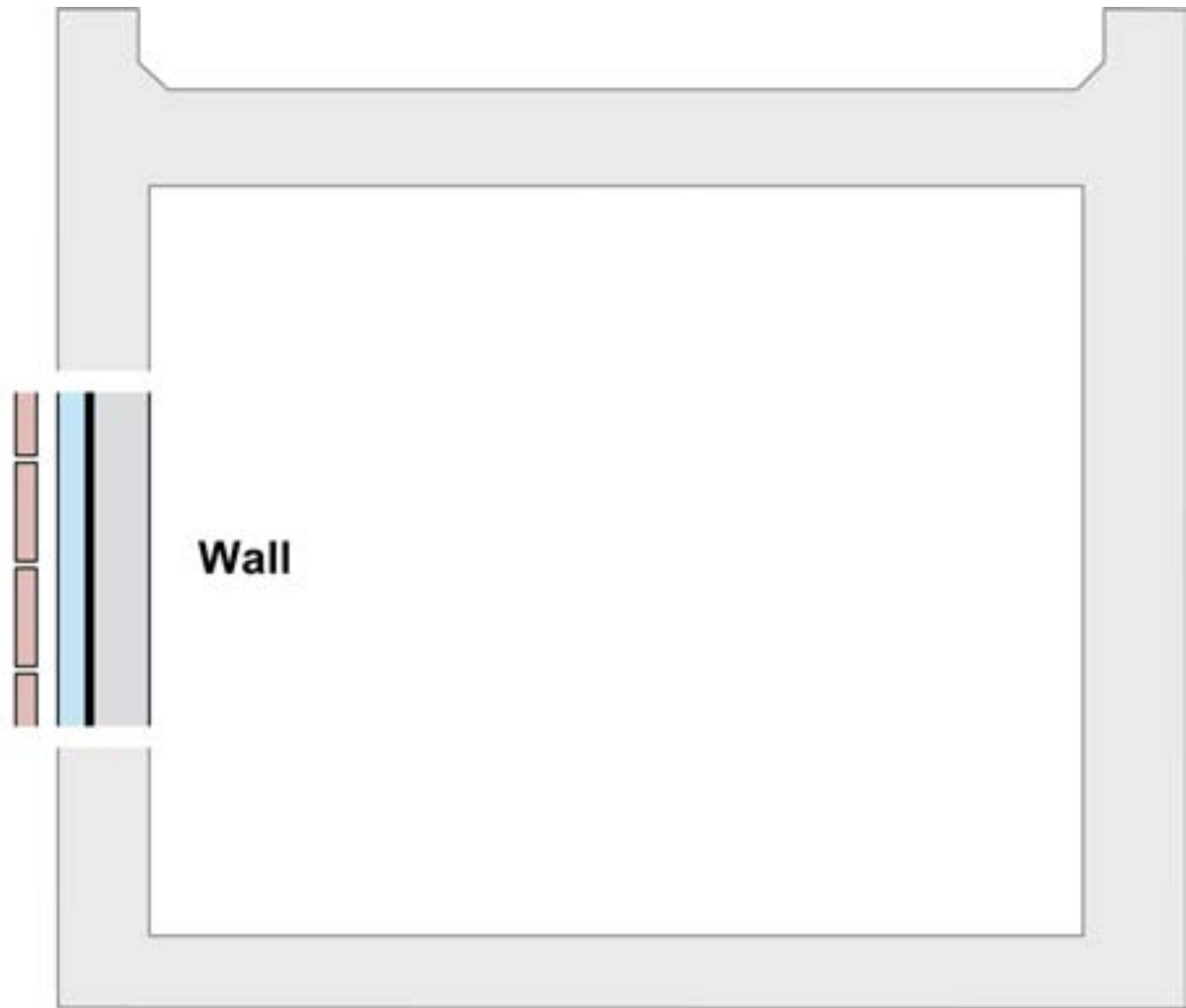

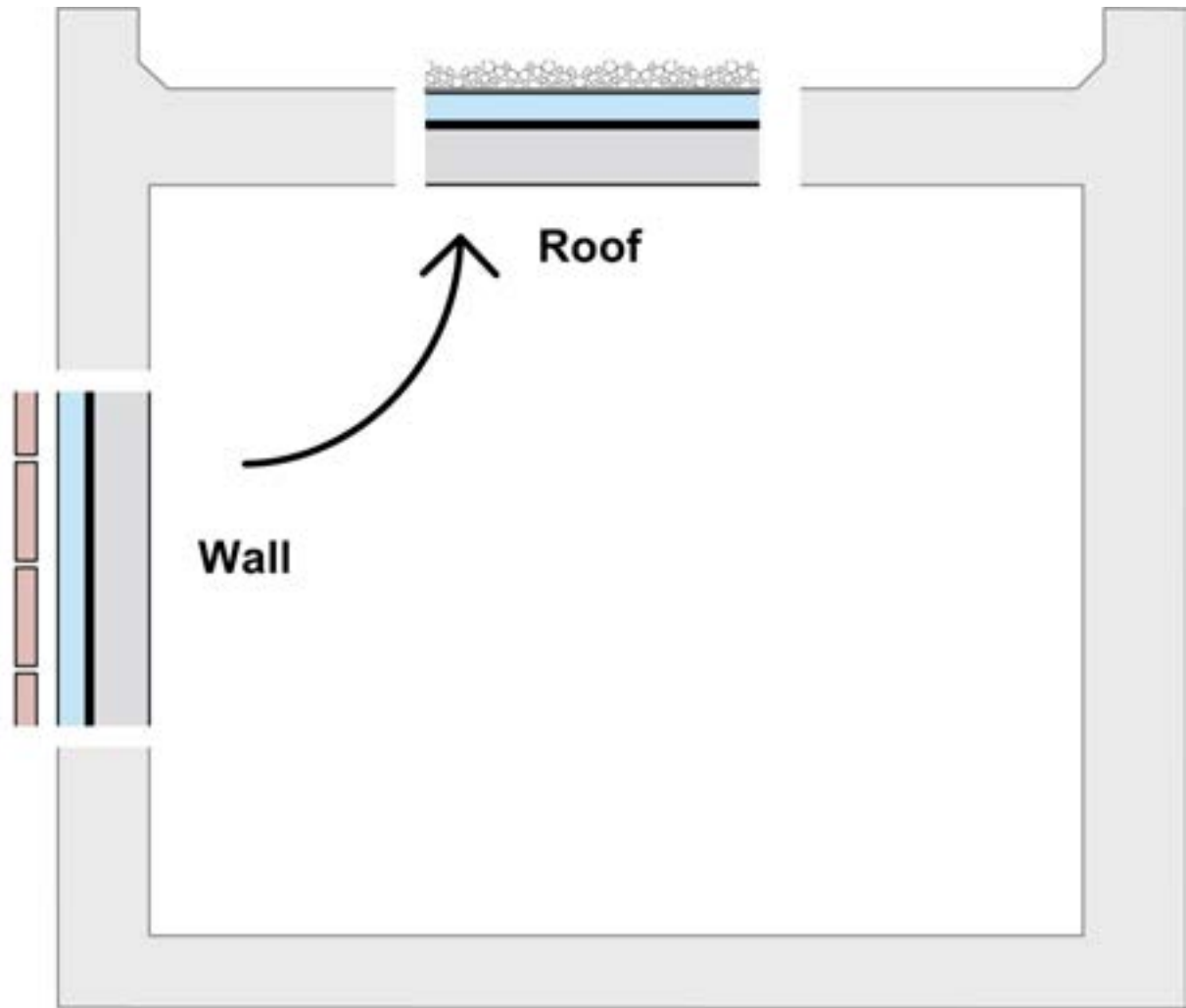

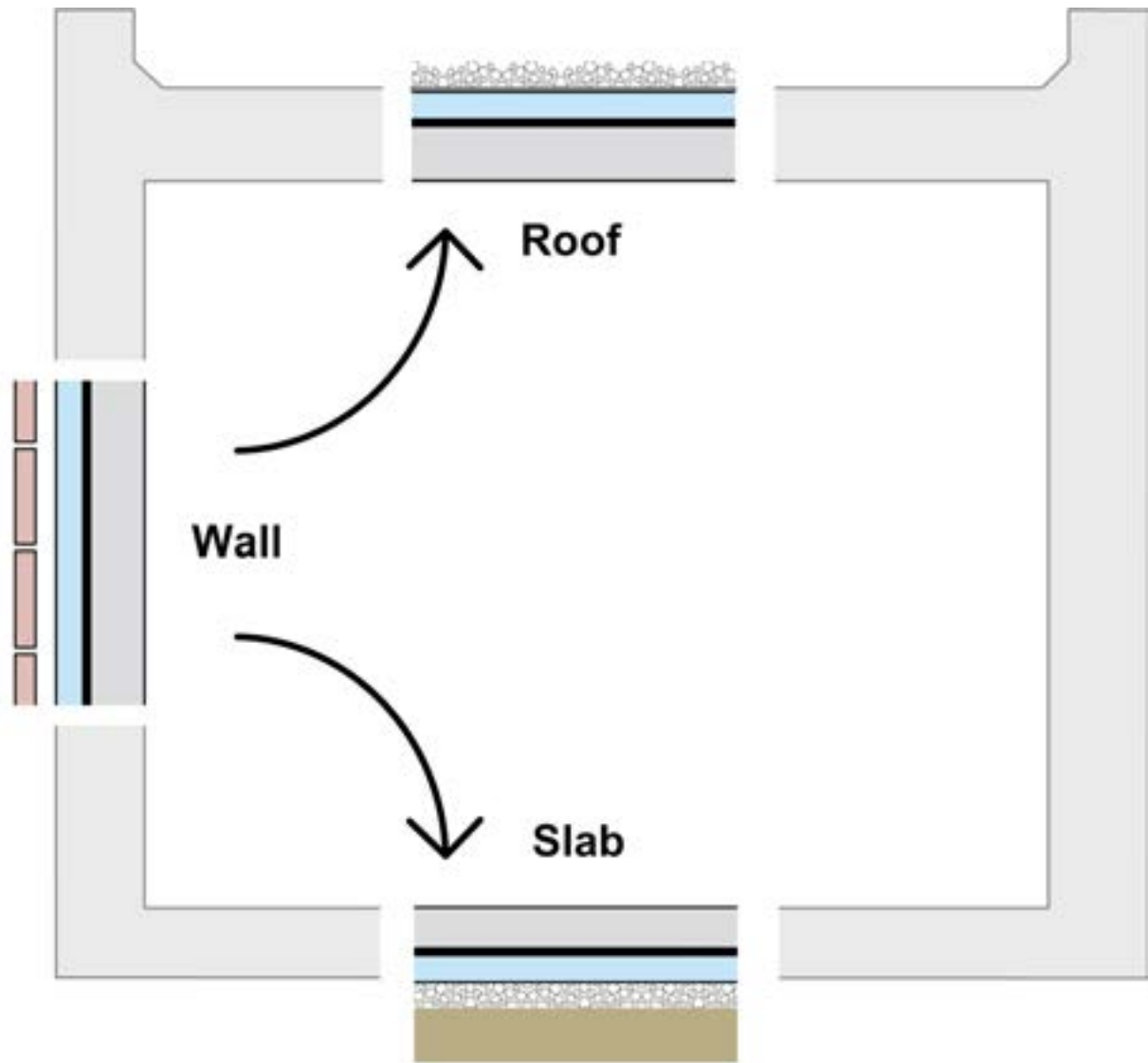

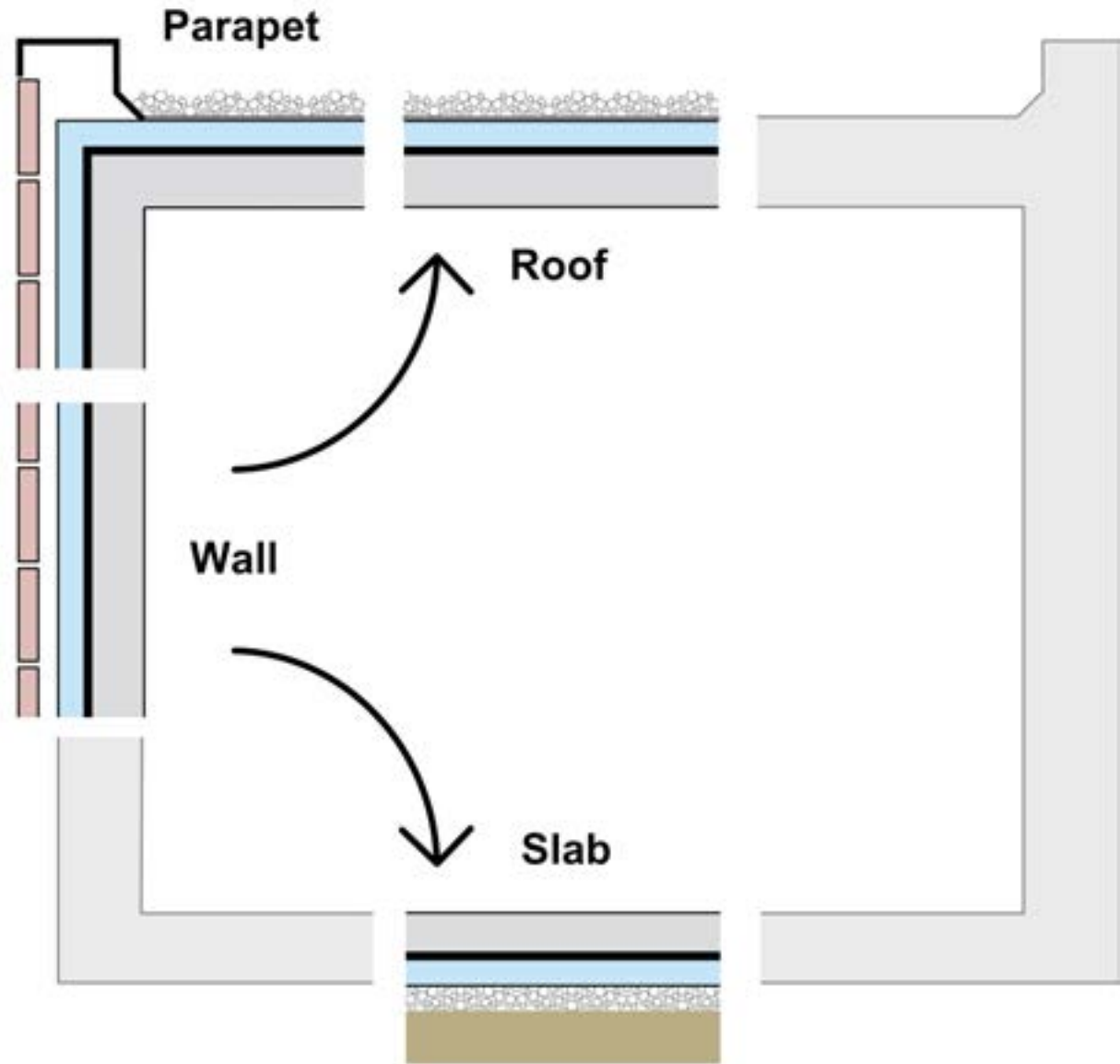

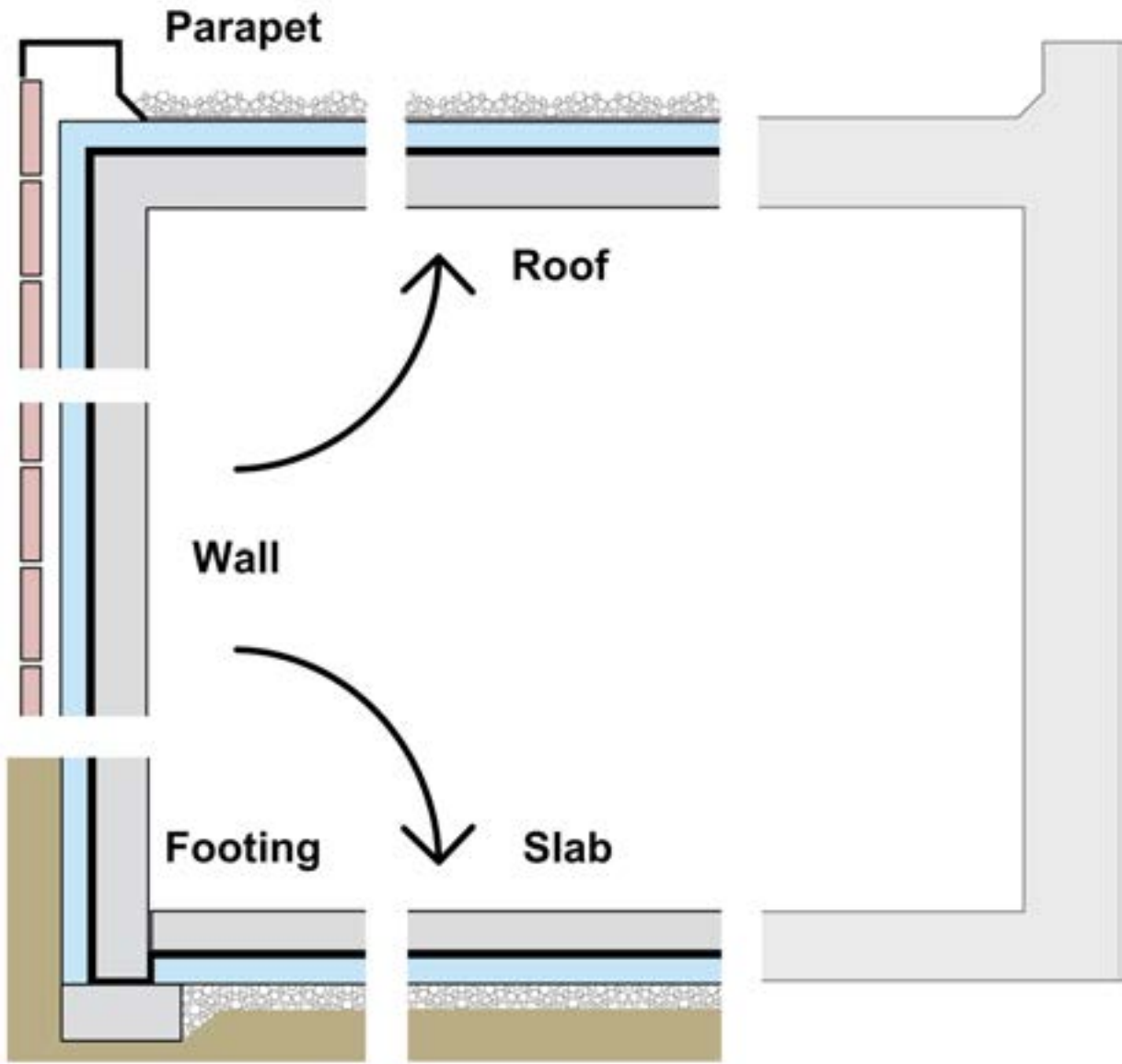



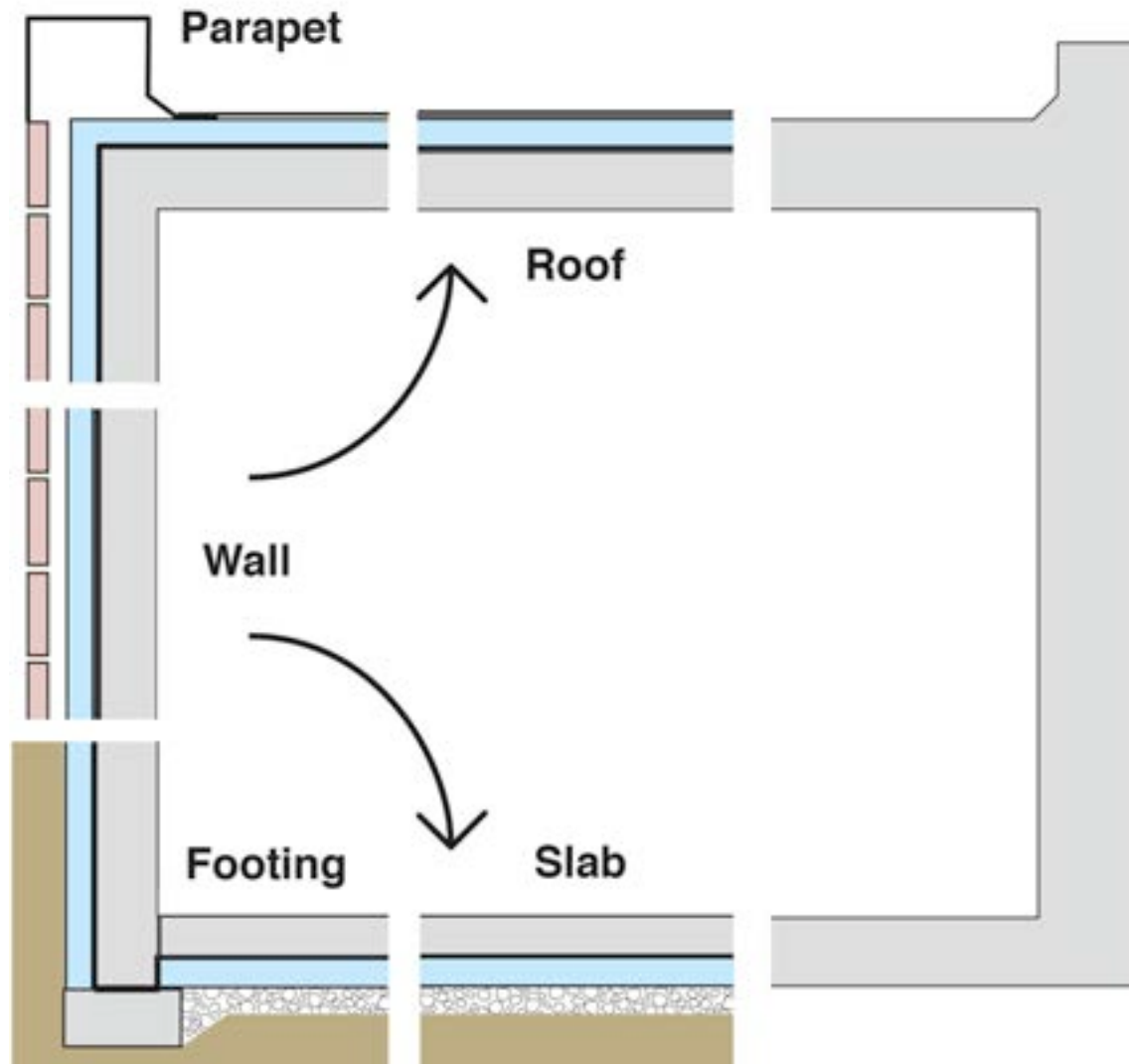

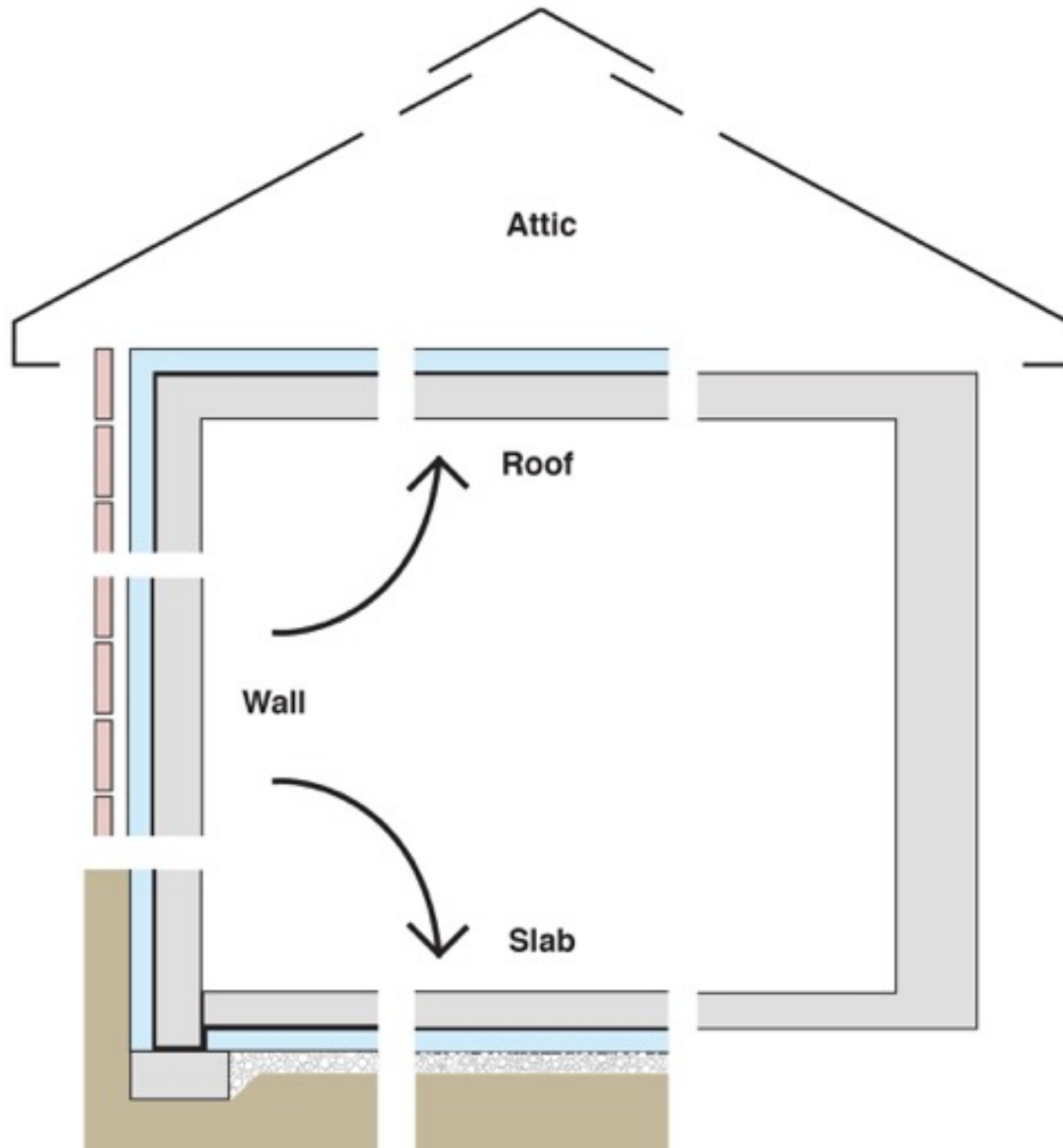

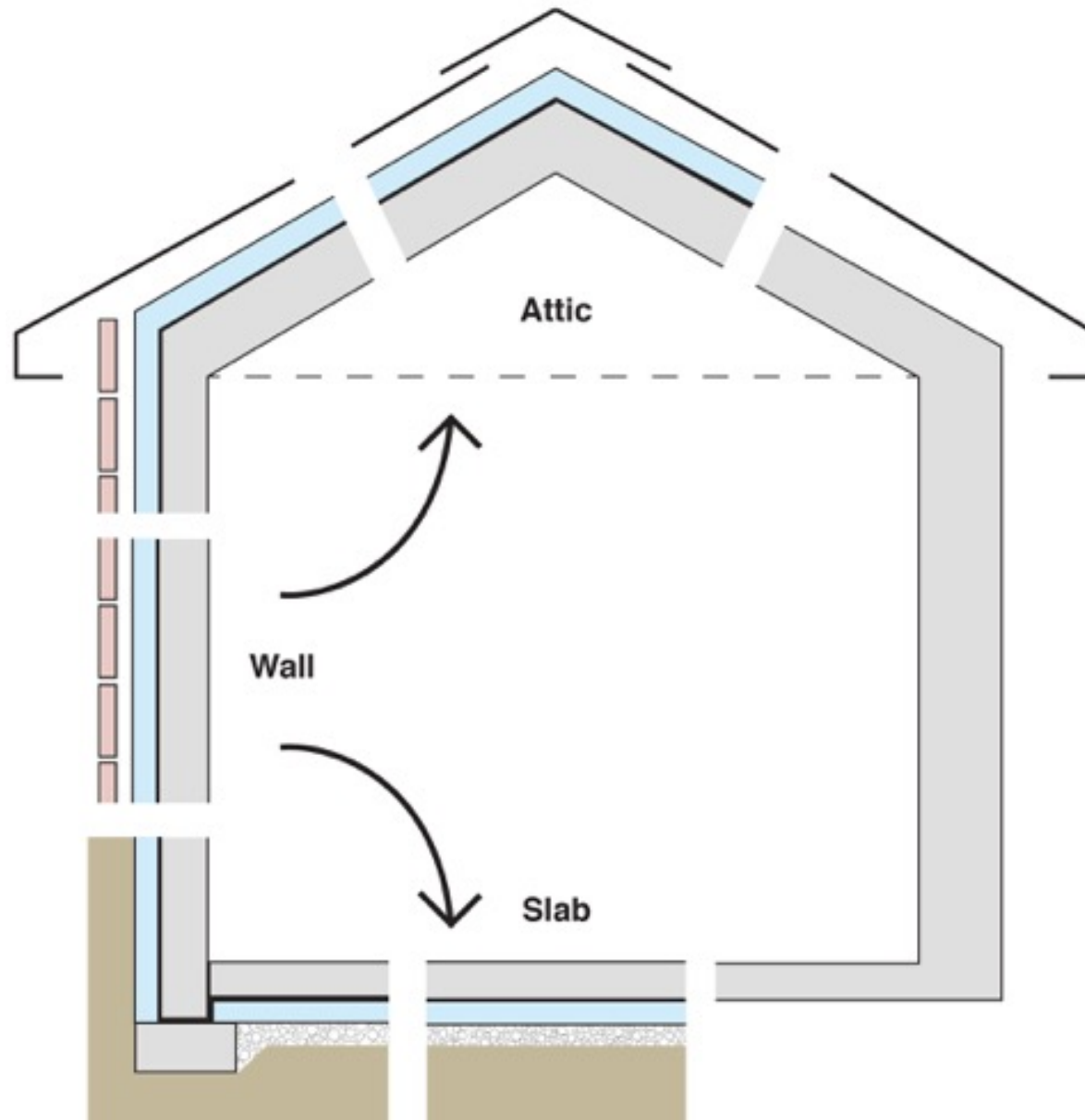

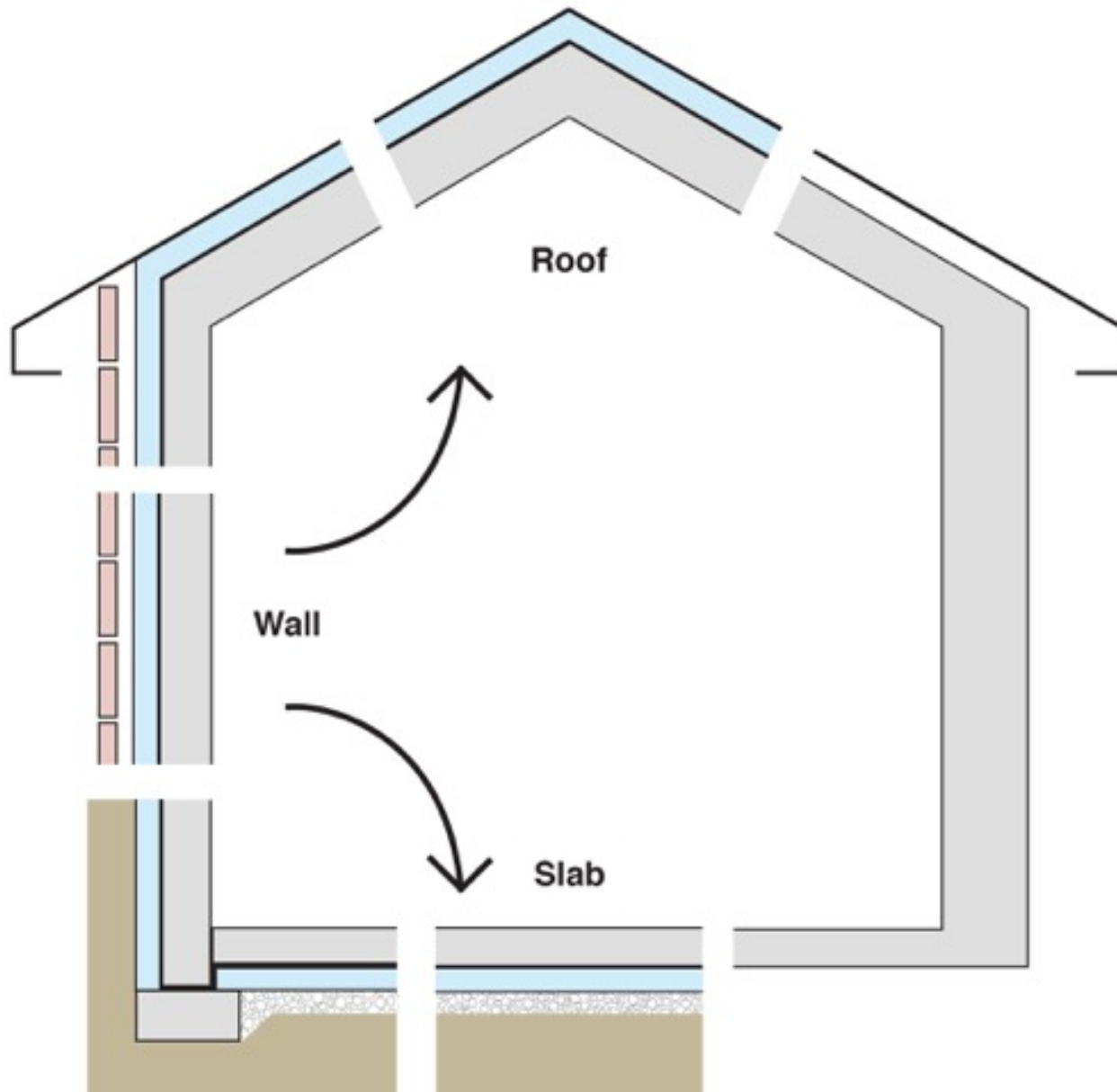

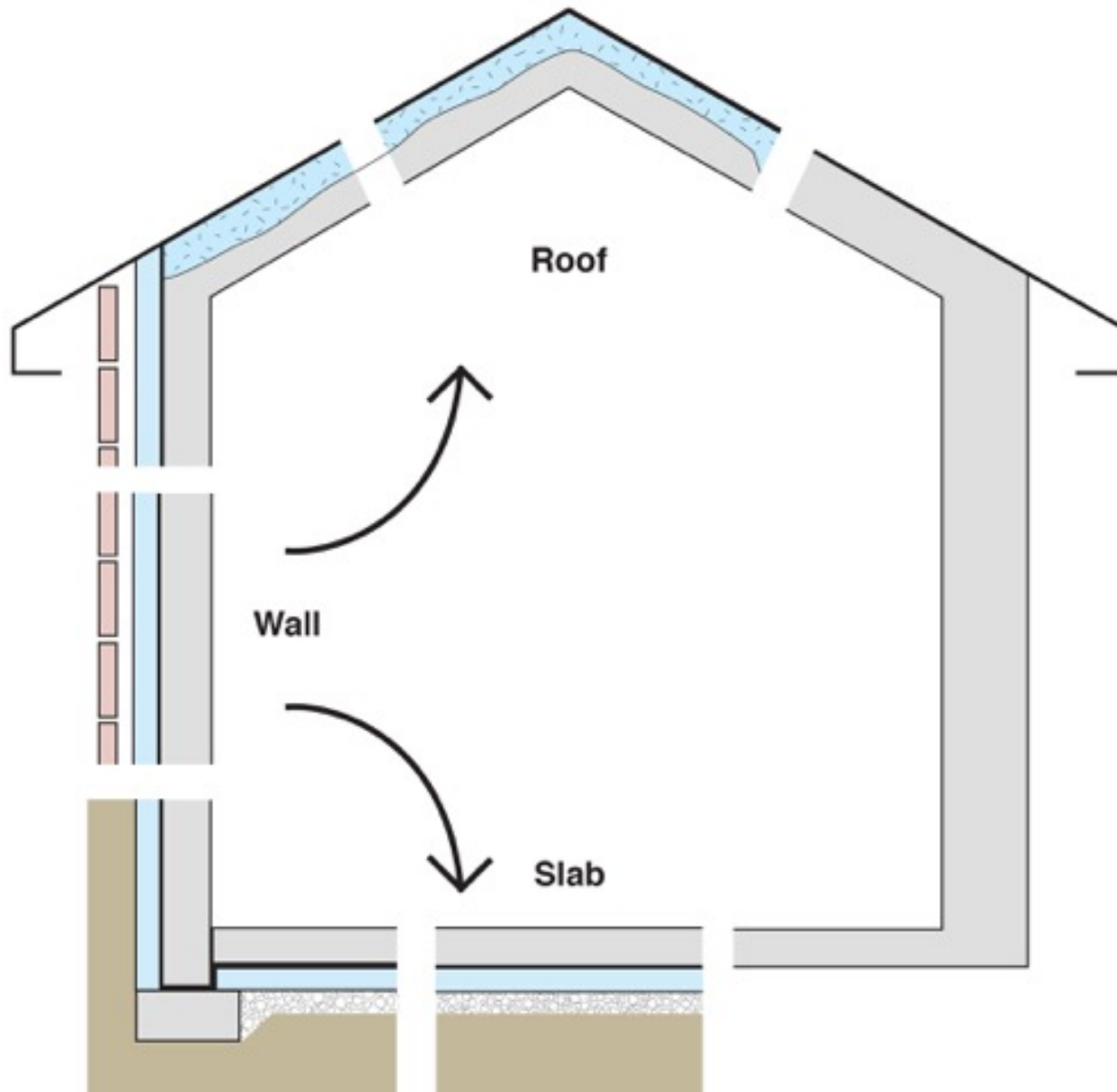

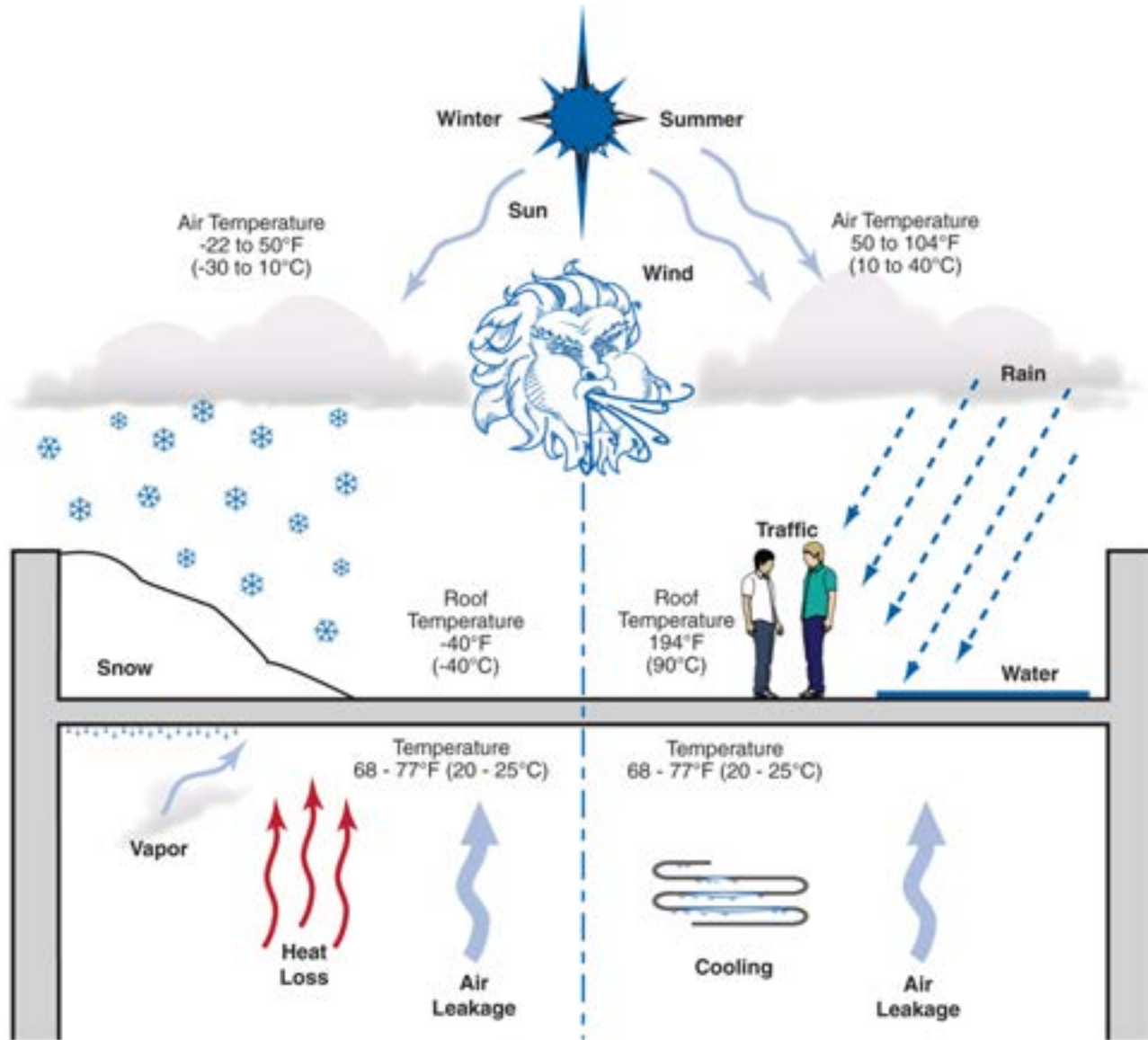

Adapted from Baker, M.: *Roofs*, 1980;
 Courtesy National Research Council of Canada

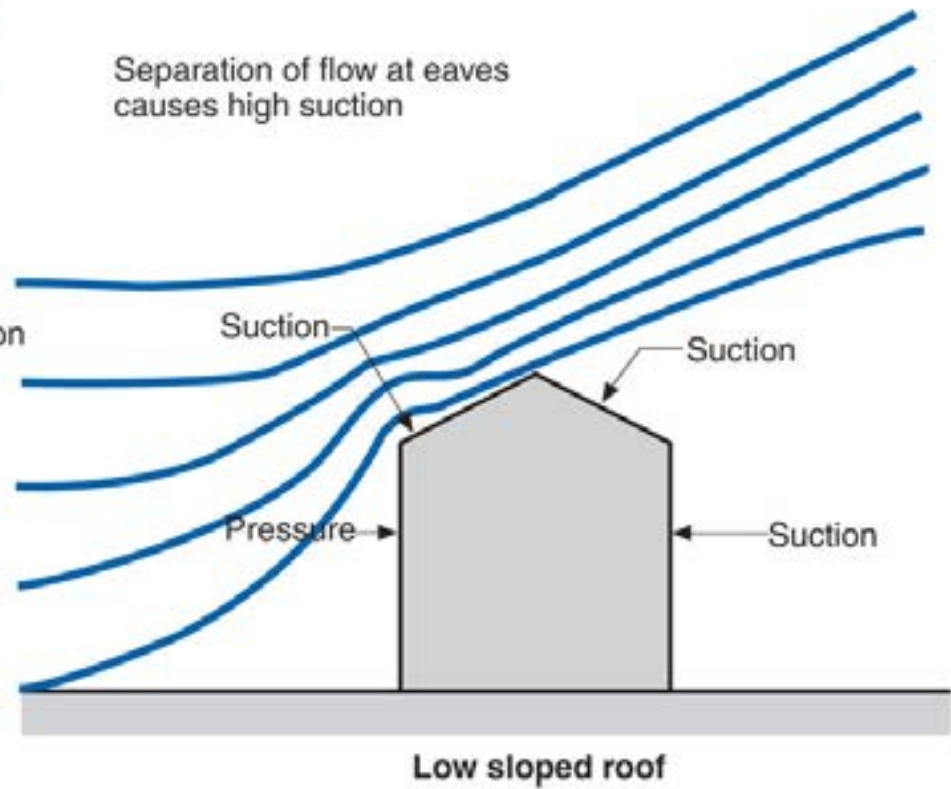
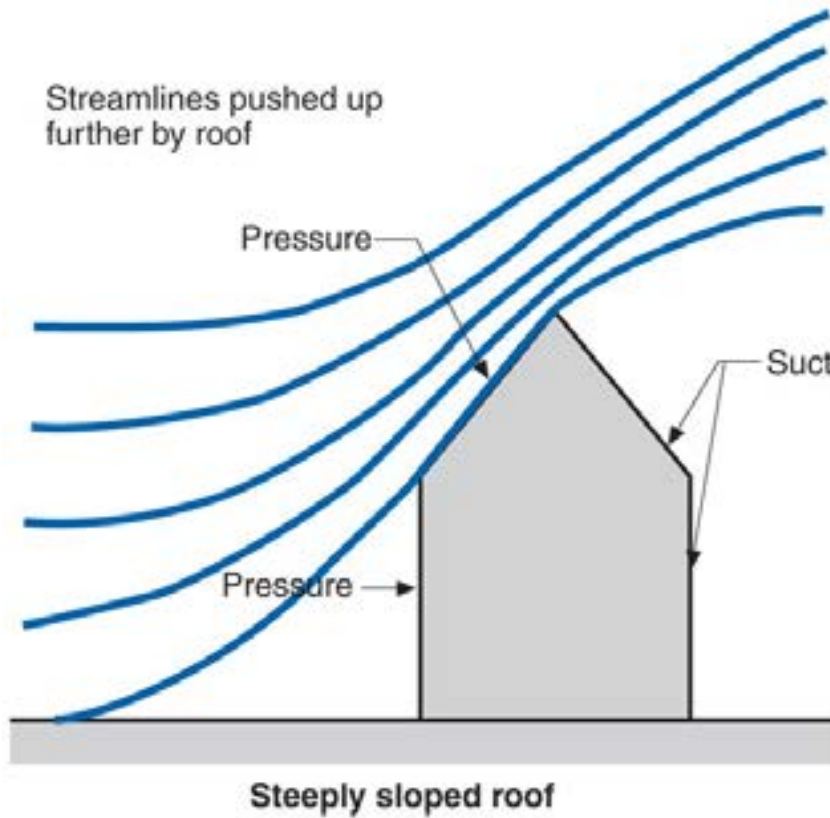

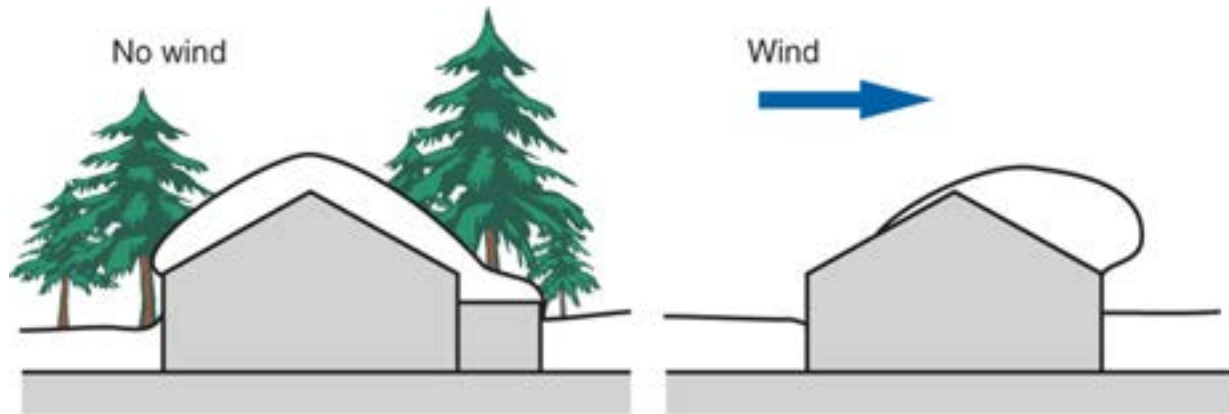

Effect of shelter

Unbalanced load

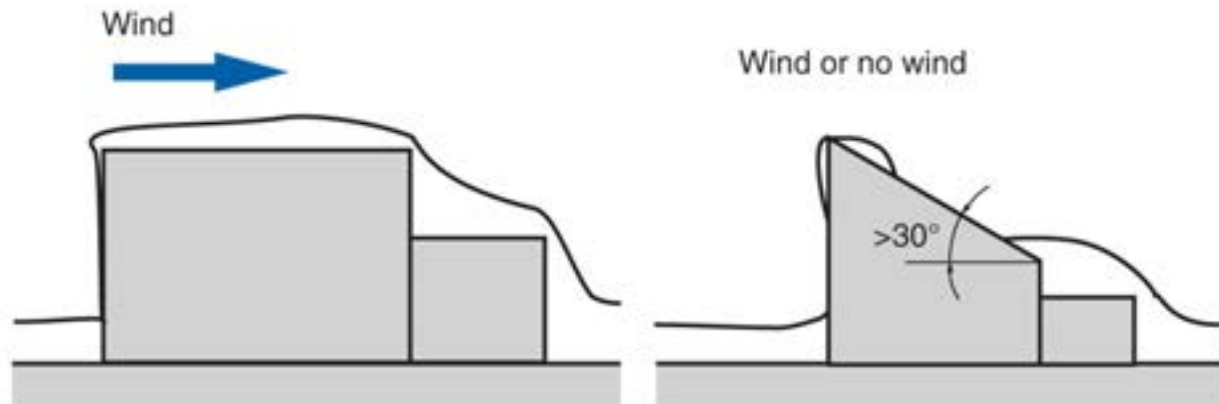

Drift on lower roof

Slide off

From Baker, M.; Roofs, 1980

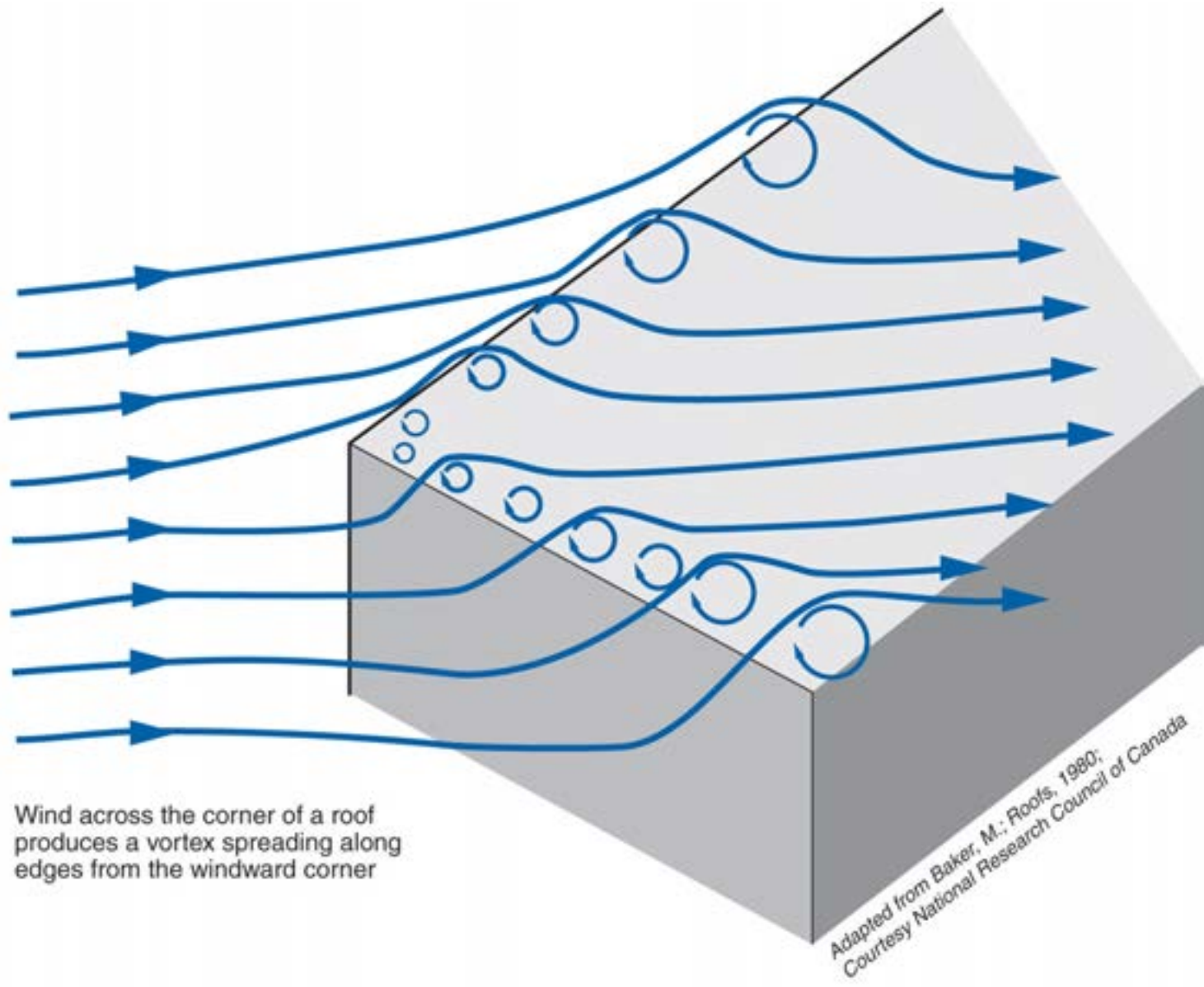

Wind across the corner of a roof produces a vortex spreading along edges from the windward corner

Adapted from Baker, M.: *Roofs*, 1980;
Courtesy National Research Council of Canada

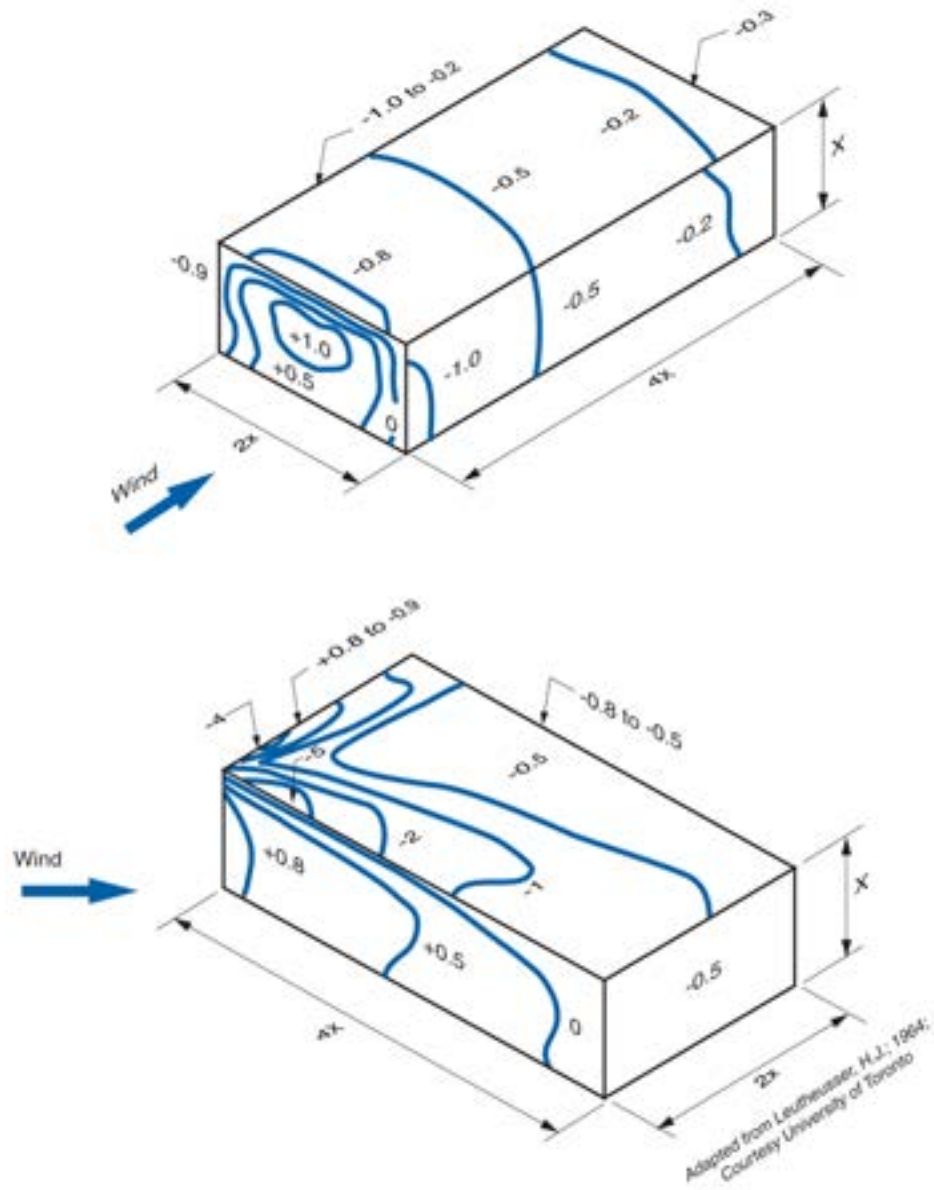

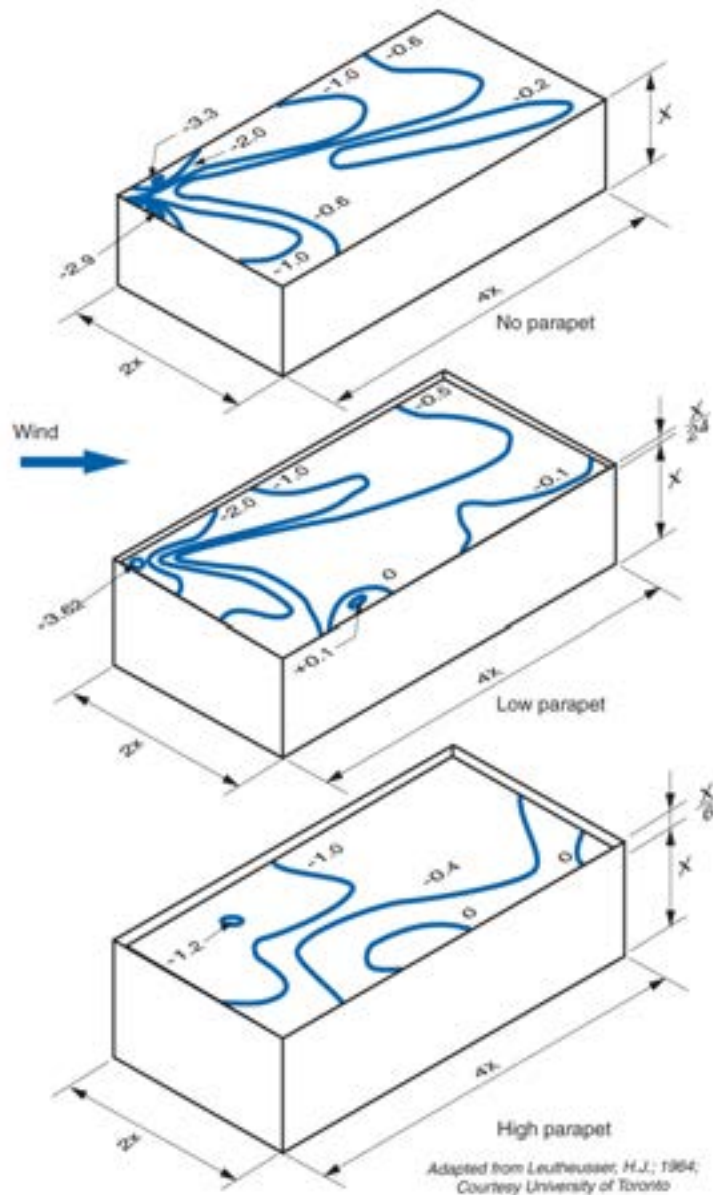

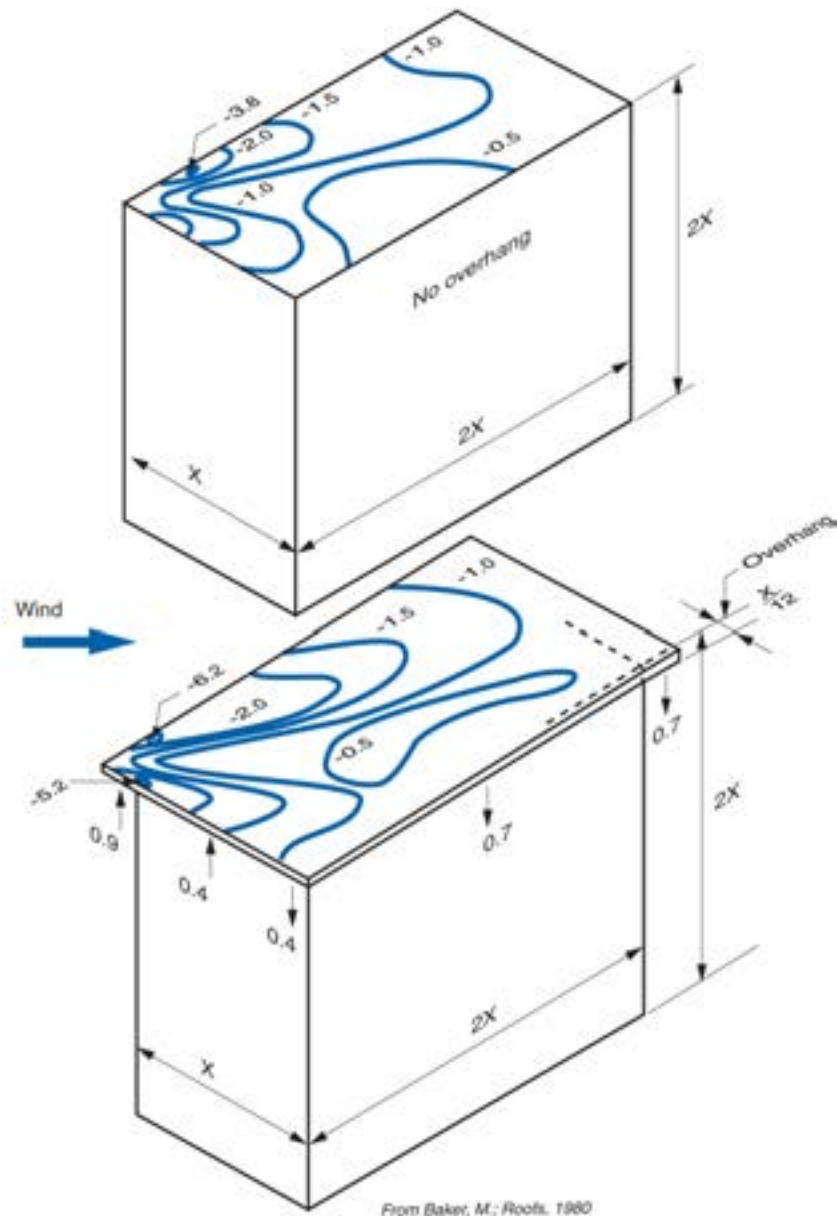

From Baker, M.; *Roofs*, 1980

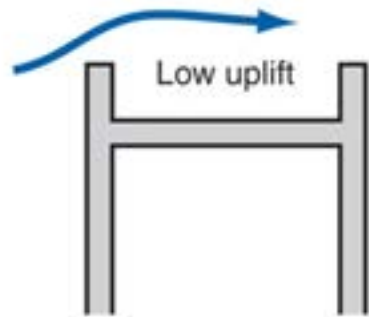

Flat roof with parapets
blow-off hazard: low
slippage hazard: low

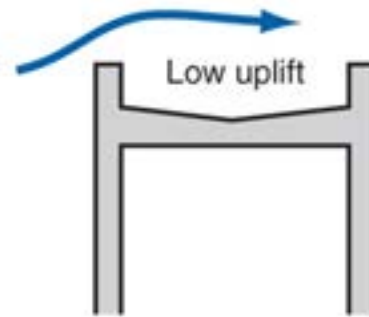

Sloped roof with parapets
blow-off hazard: low
slippage hazard: medium

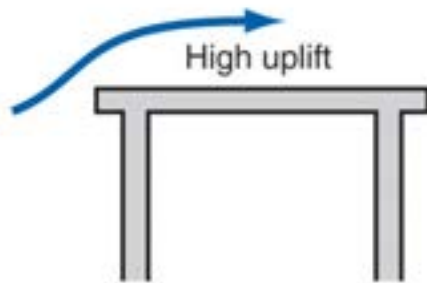

Flat roof or overhang
blow off hazard: high
slippage hazard: low

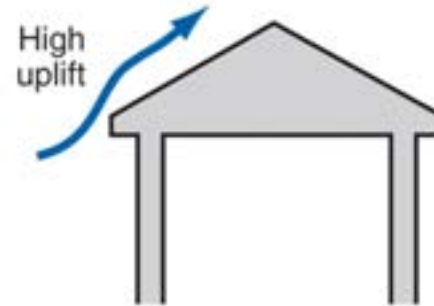

Outward sloping roof
blow-off hazard: high
slippage hazard: high

From Baker, M.; Roofs, 1980

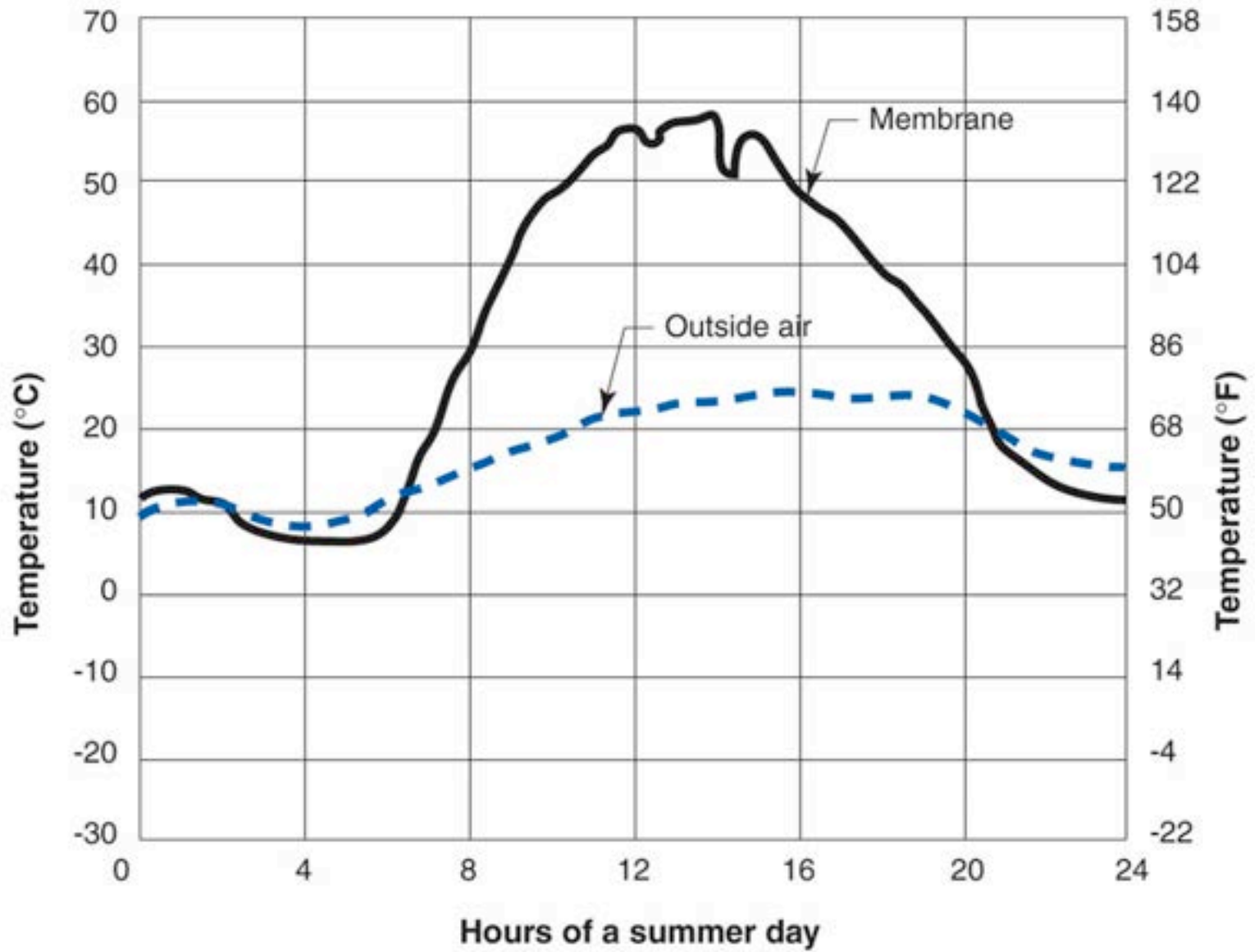

From Baker, M.; *Roofs*, 1980

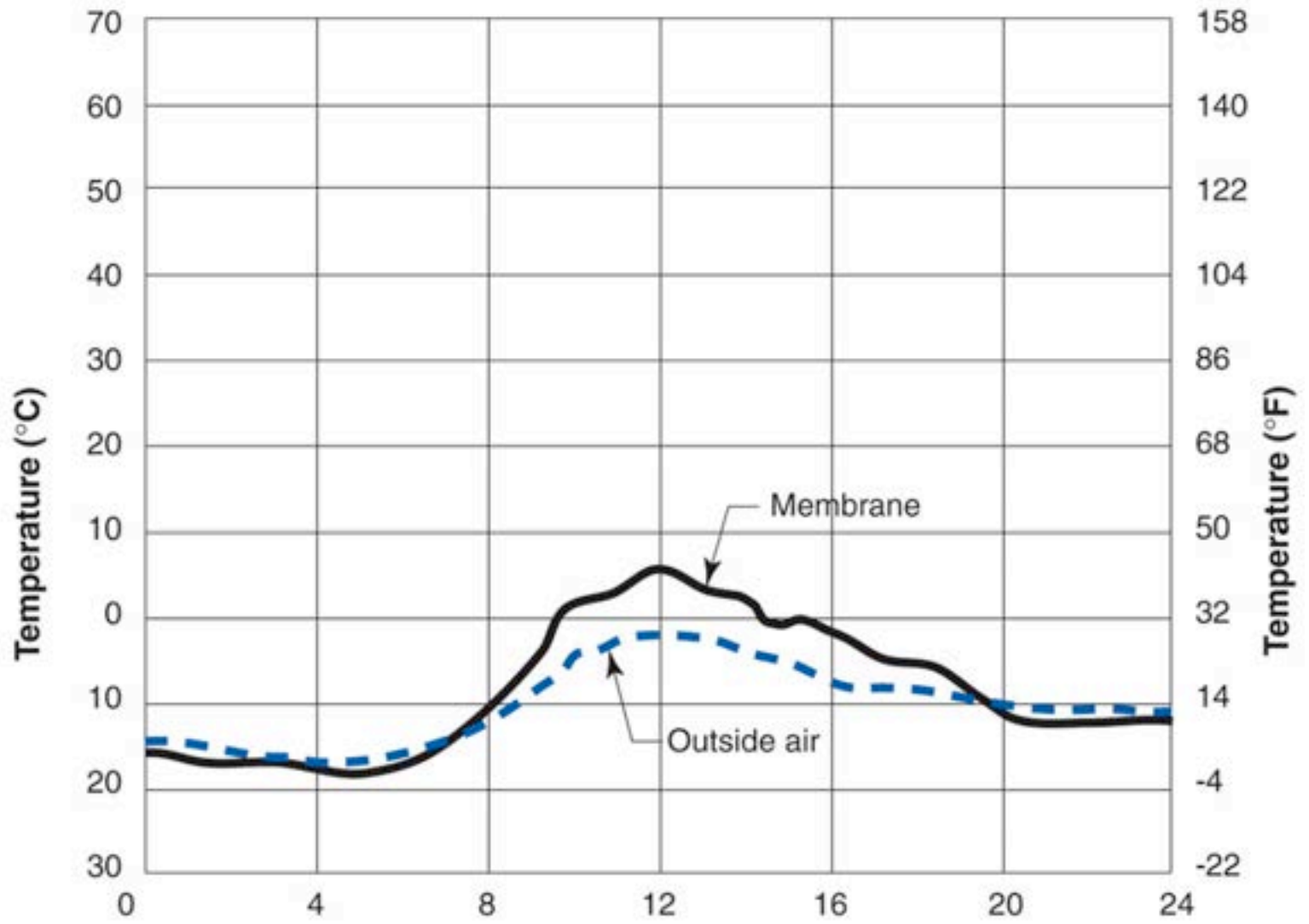

Hours of a winter day

From Baker, M.; Roofs, 1980

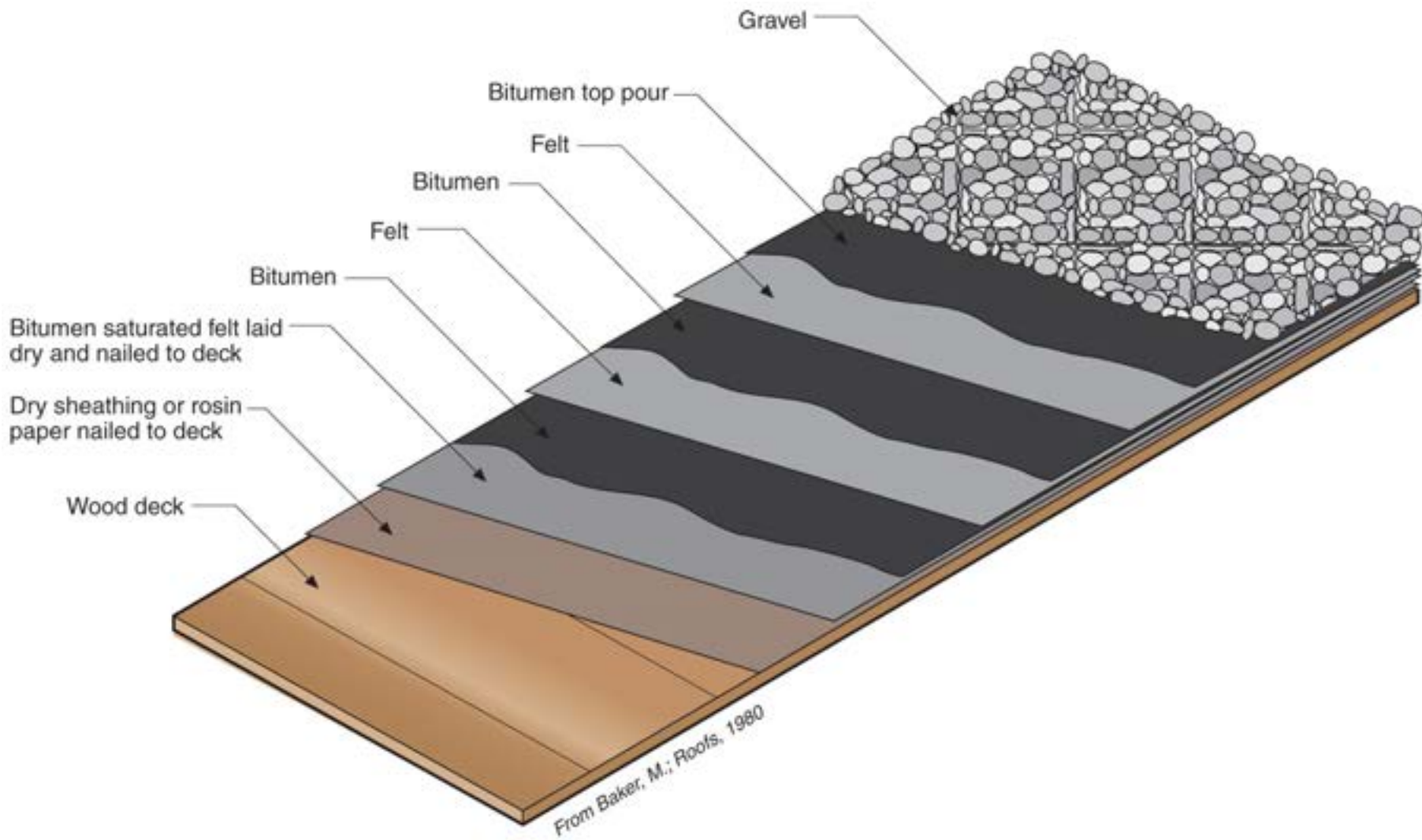

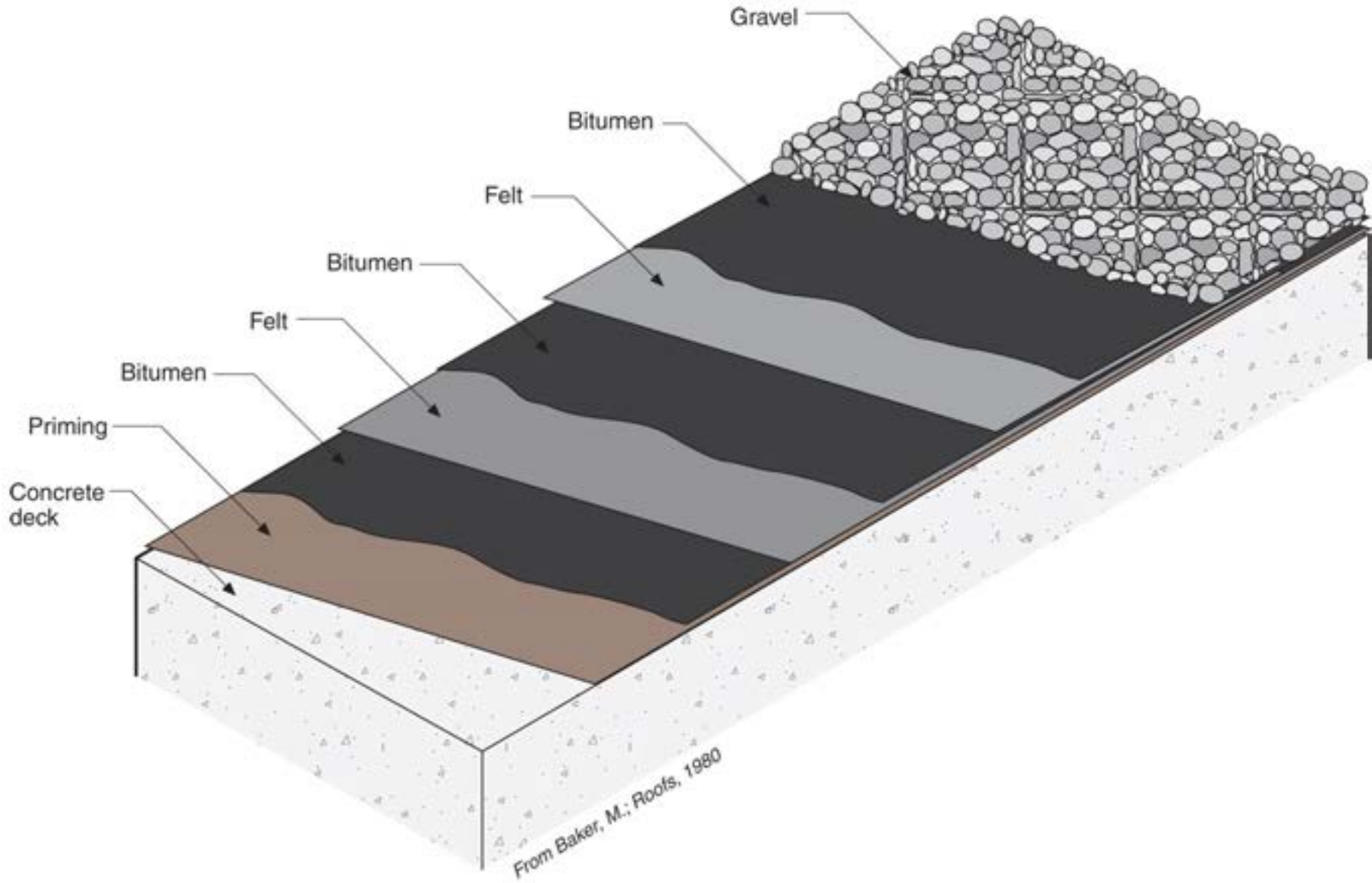

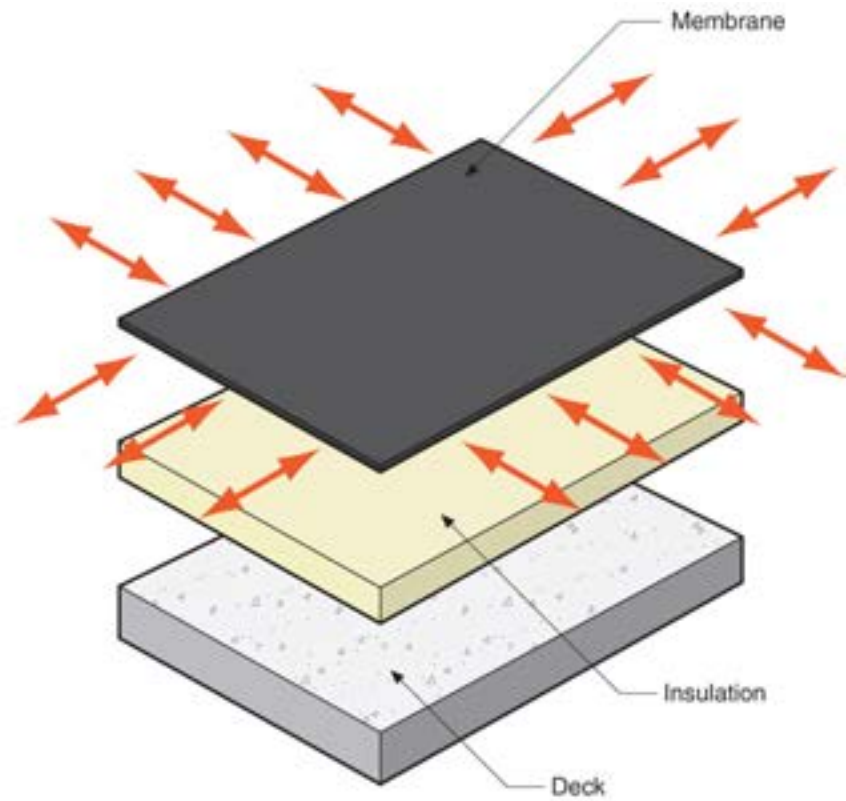
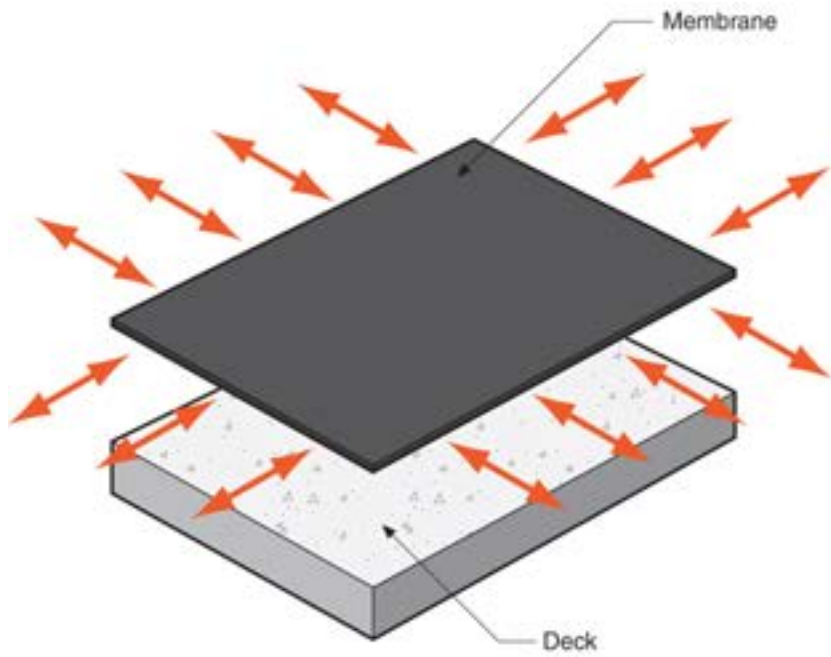

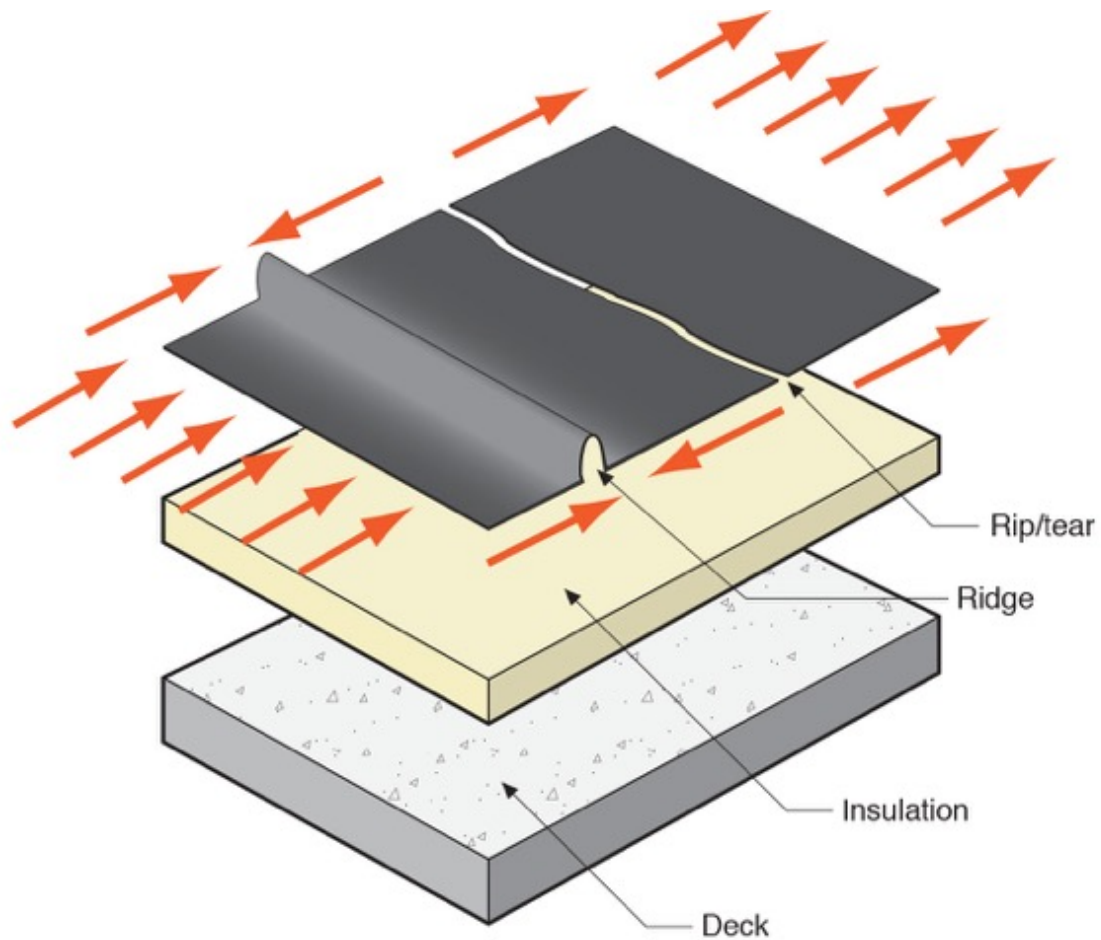



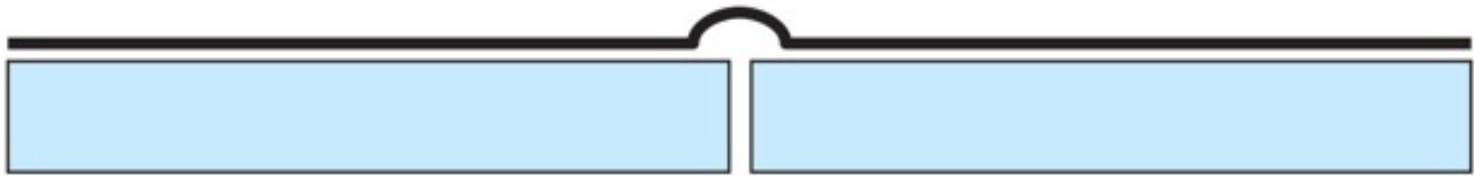
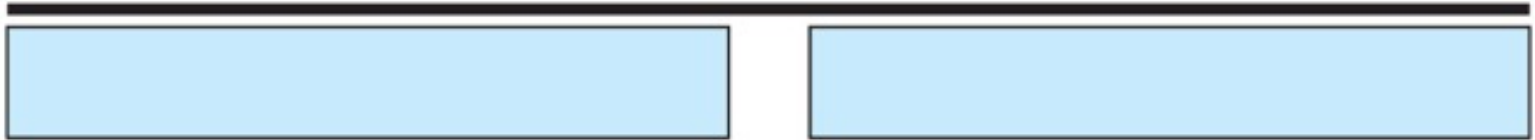



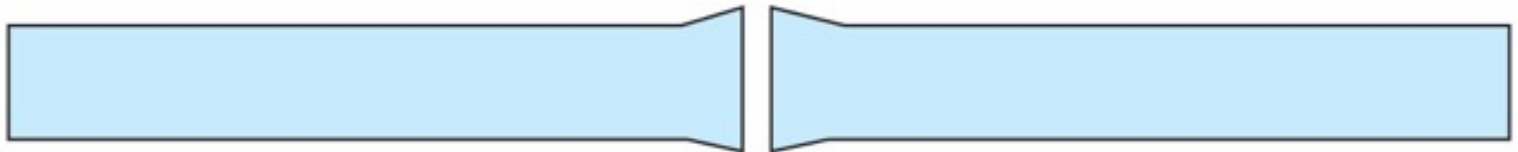
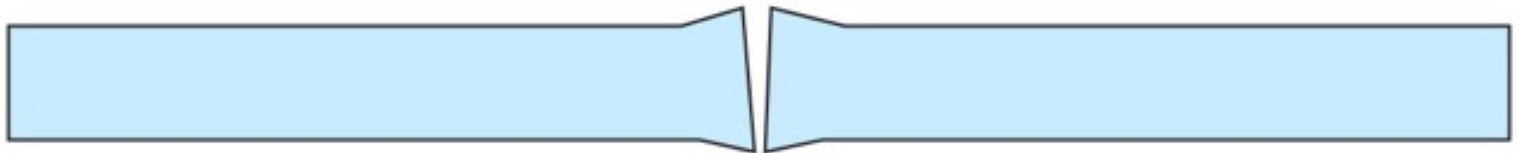

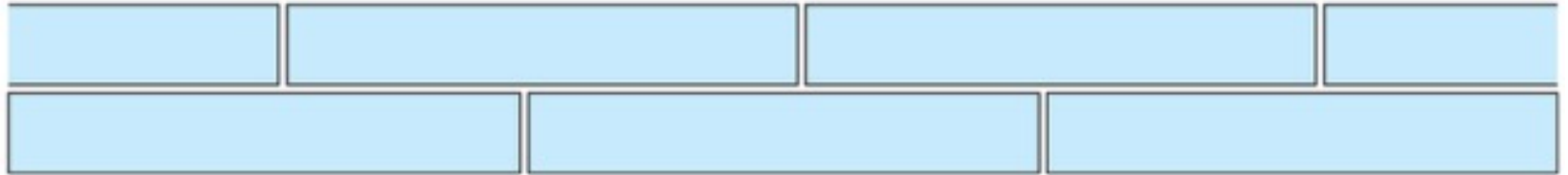





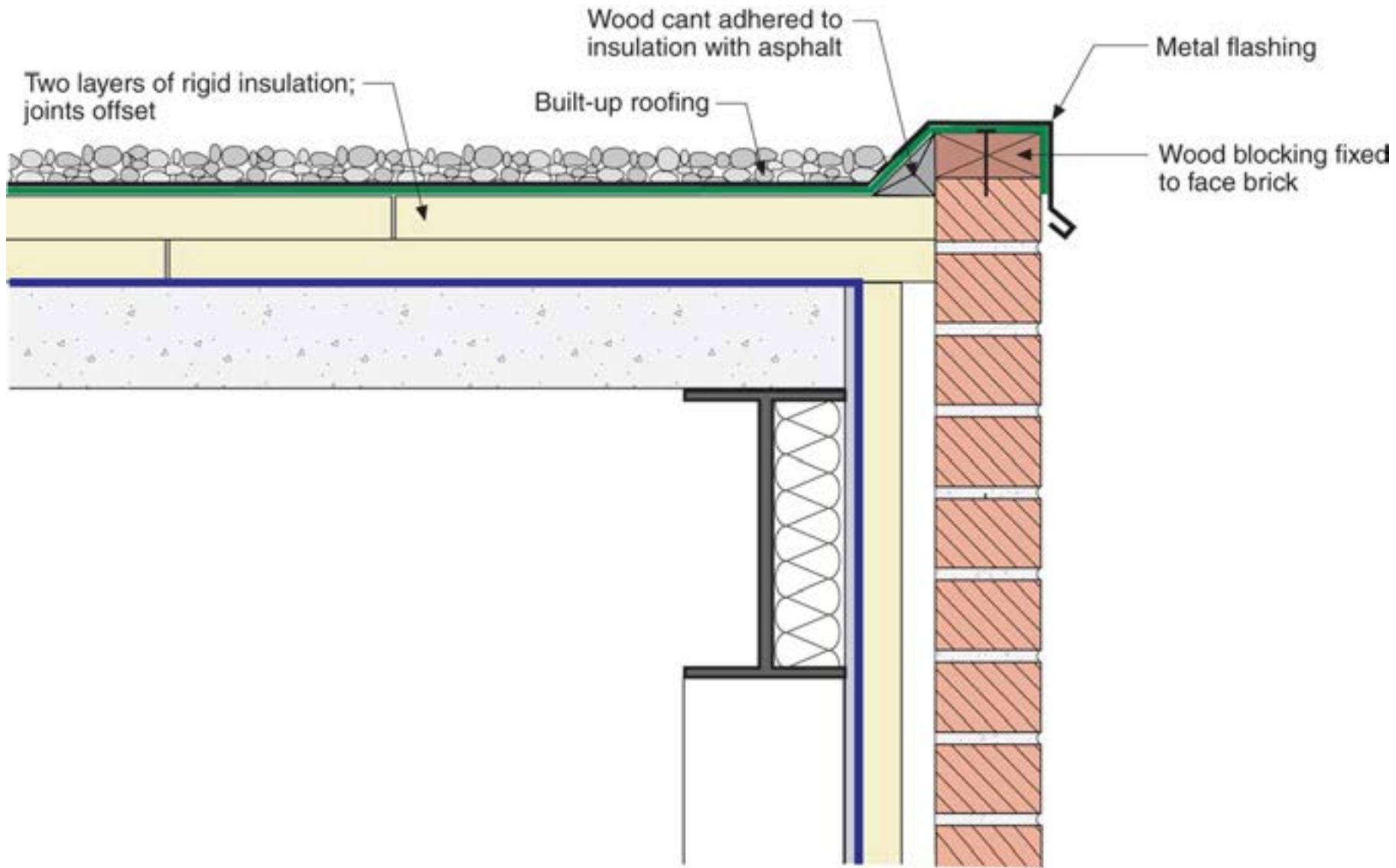

Adapted from Baker, M.; Roofs, 1980

Insulation moved because of poor adhesion to deck and between layers

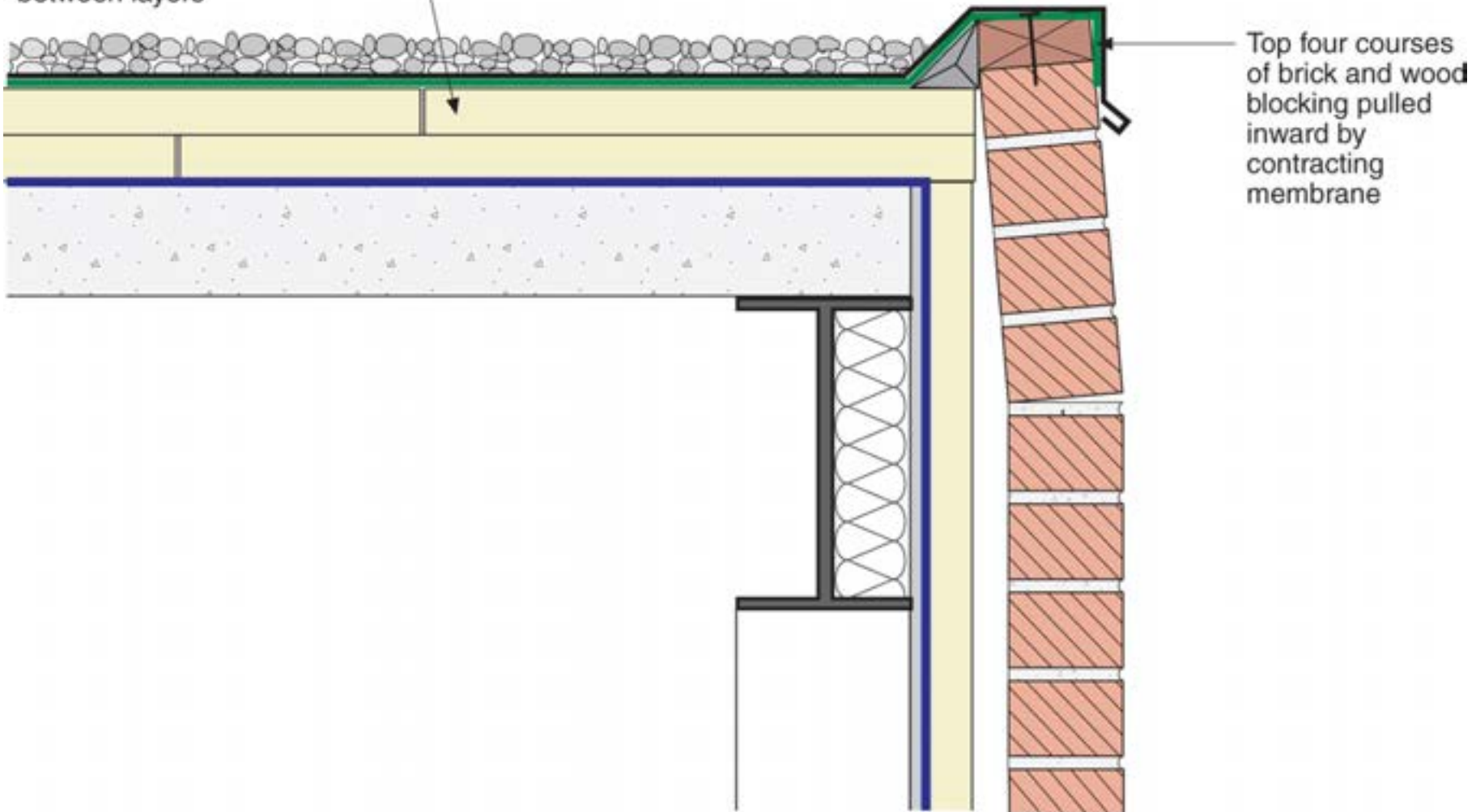

Adapted from Baker, M.; *Roofs*, 1980;
Courtesy National Research Council of Canada

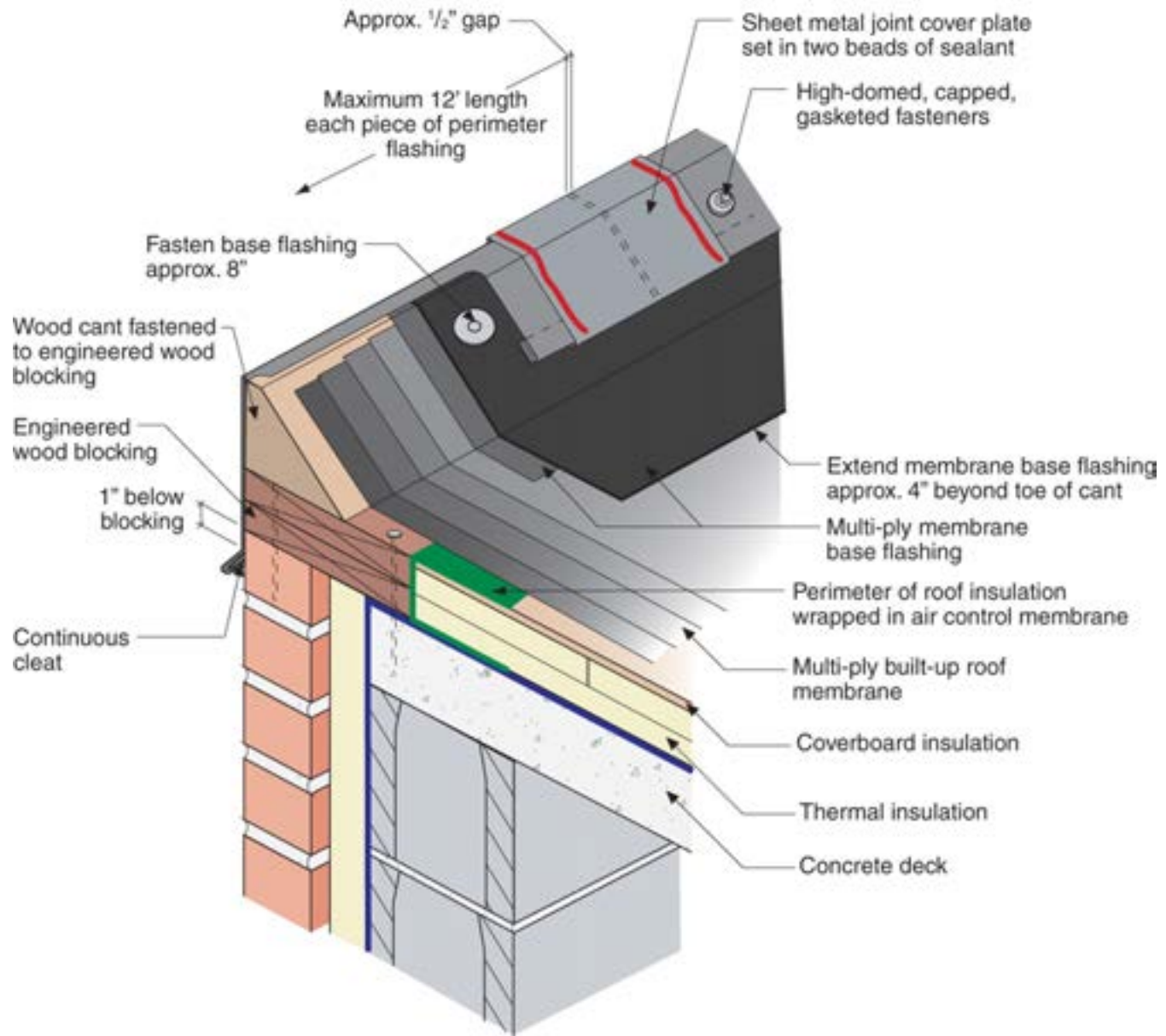

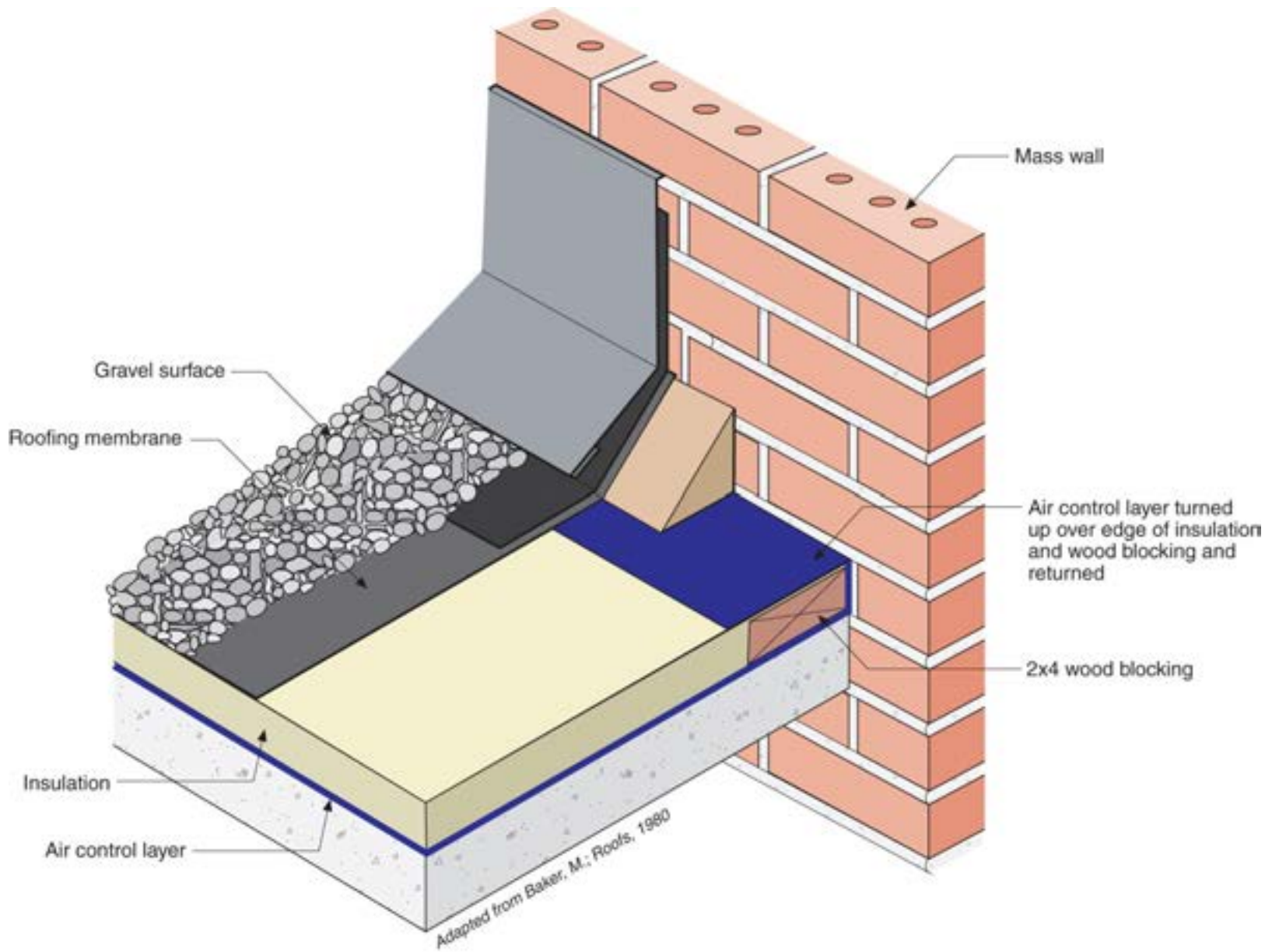

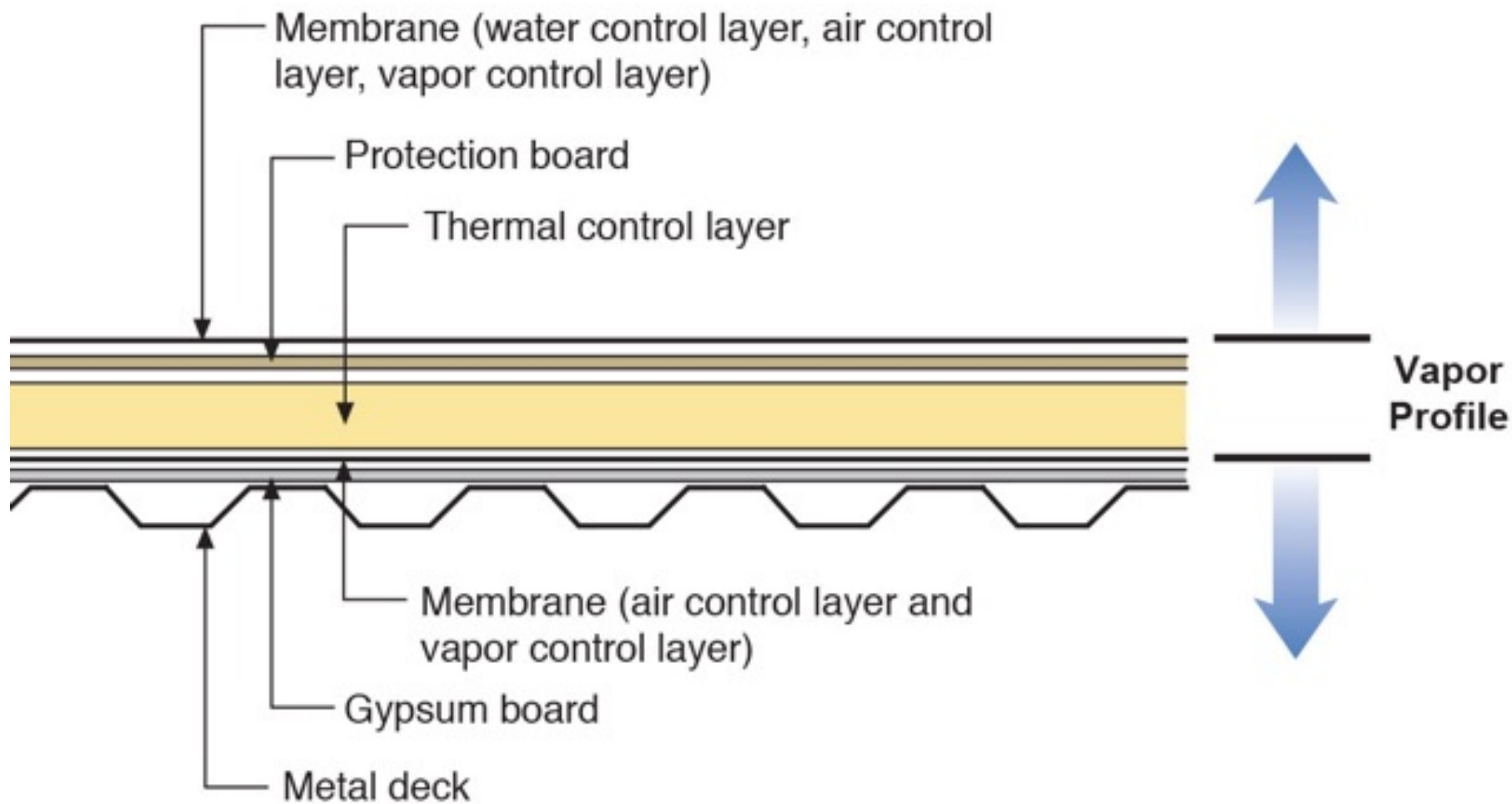

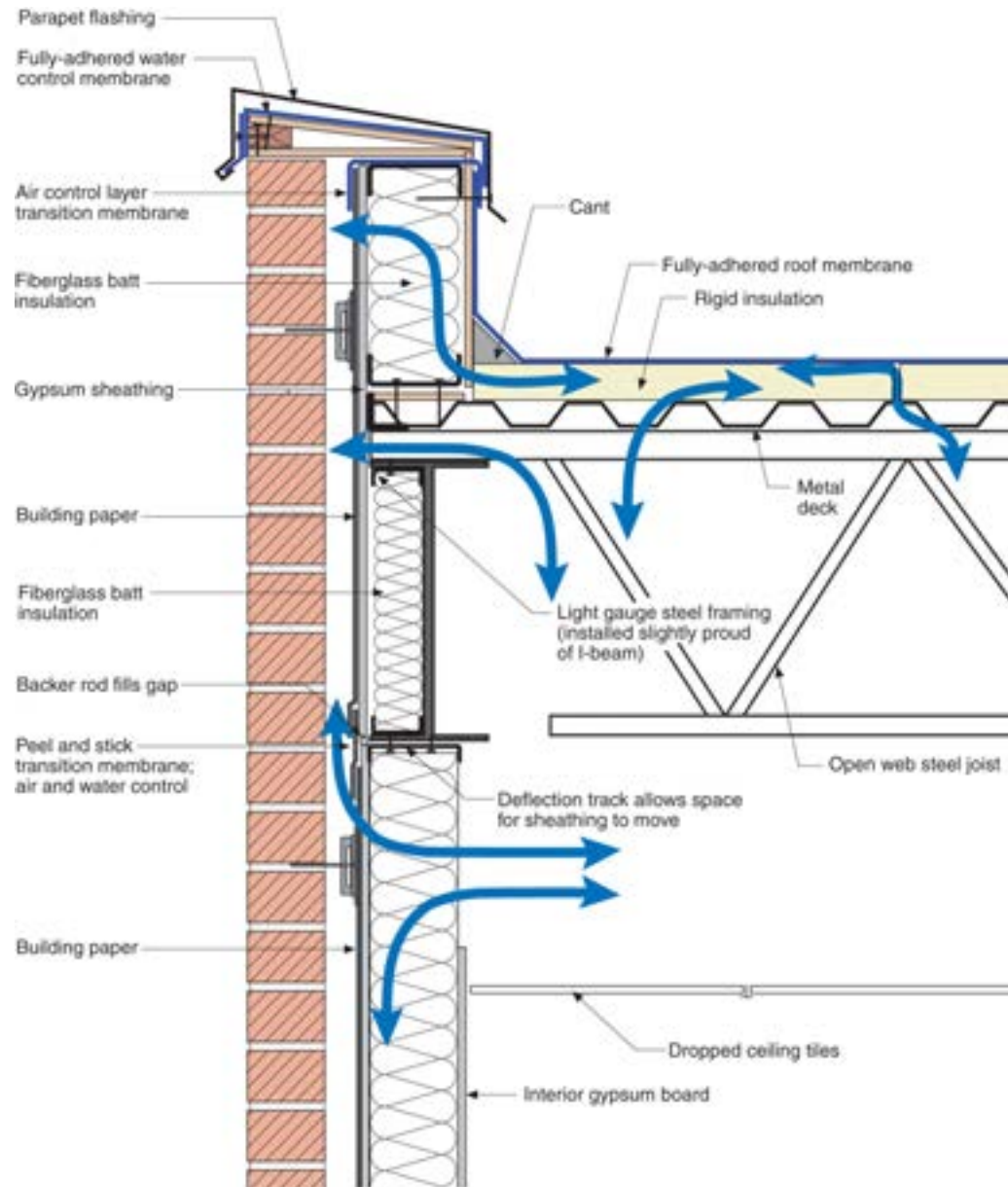

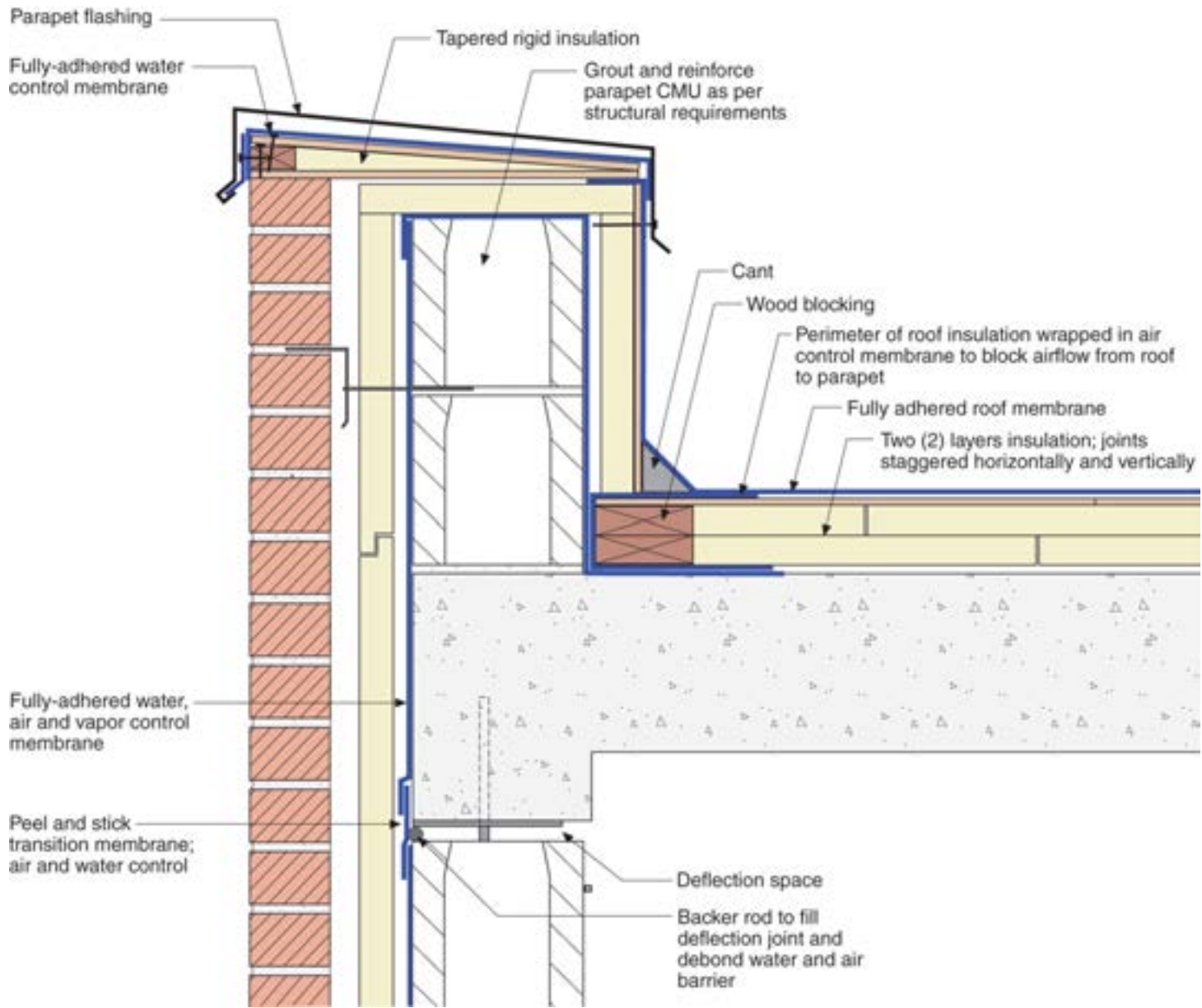

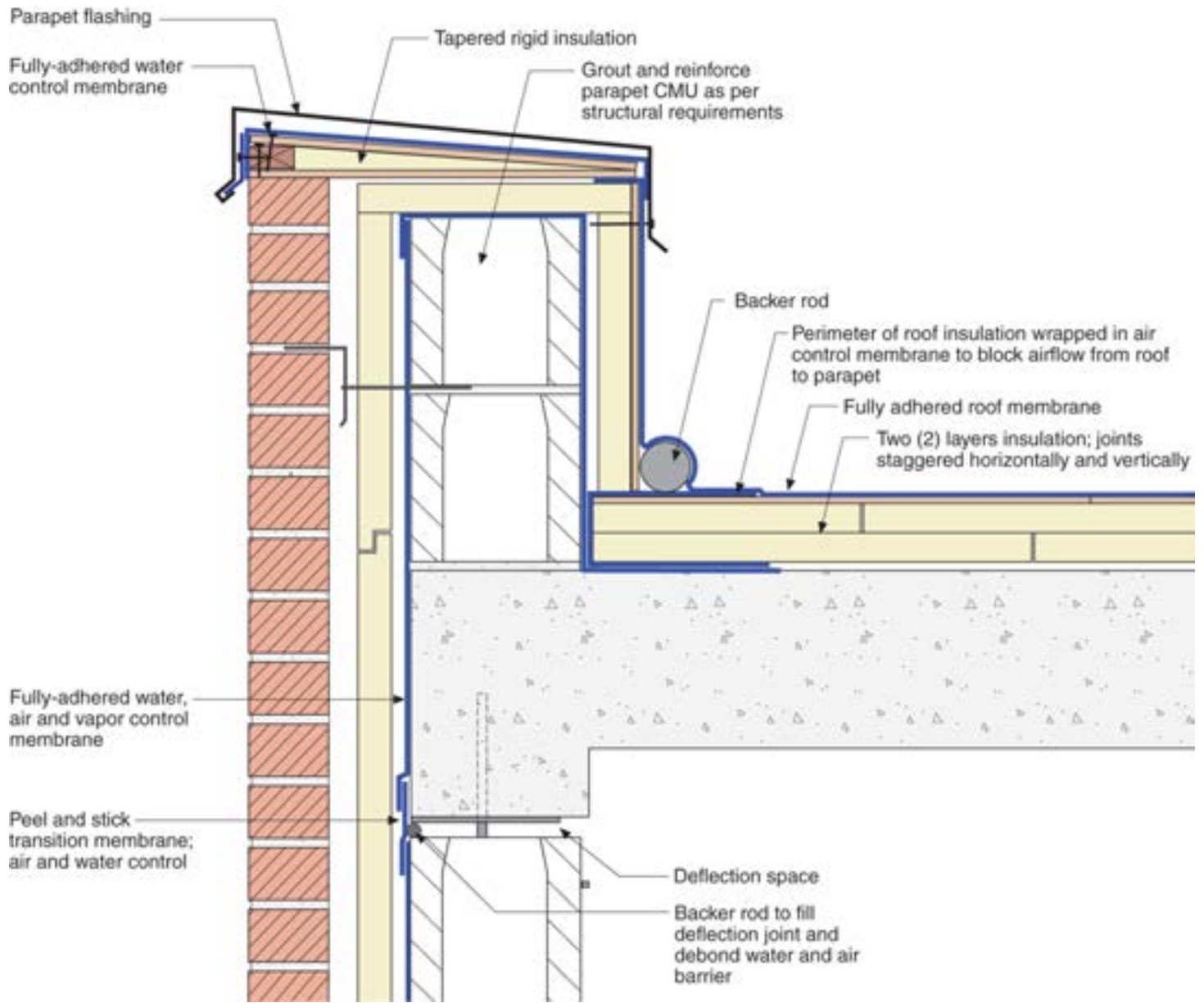

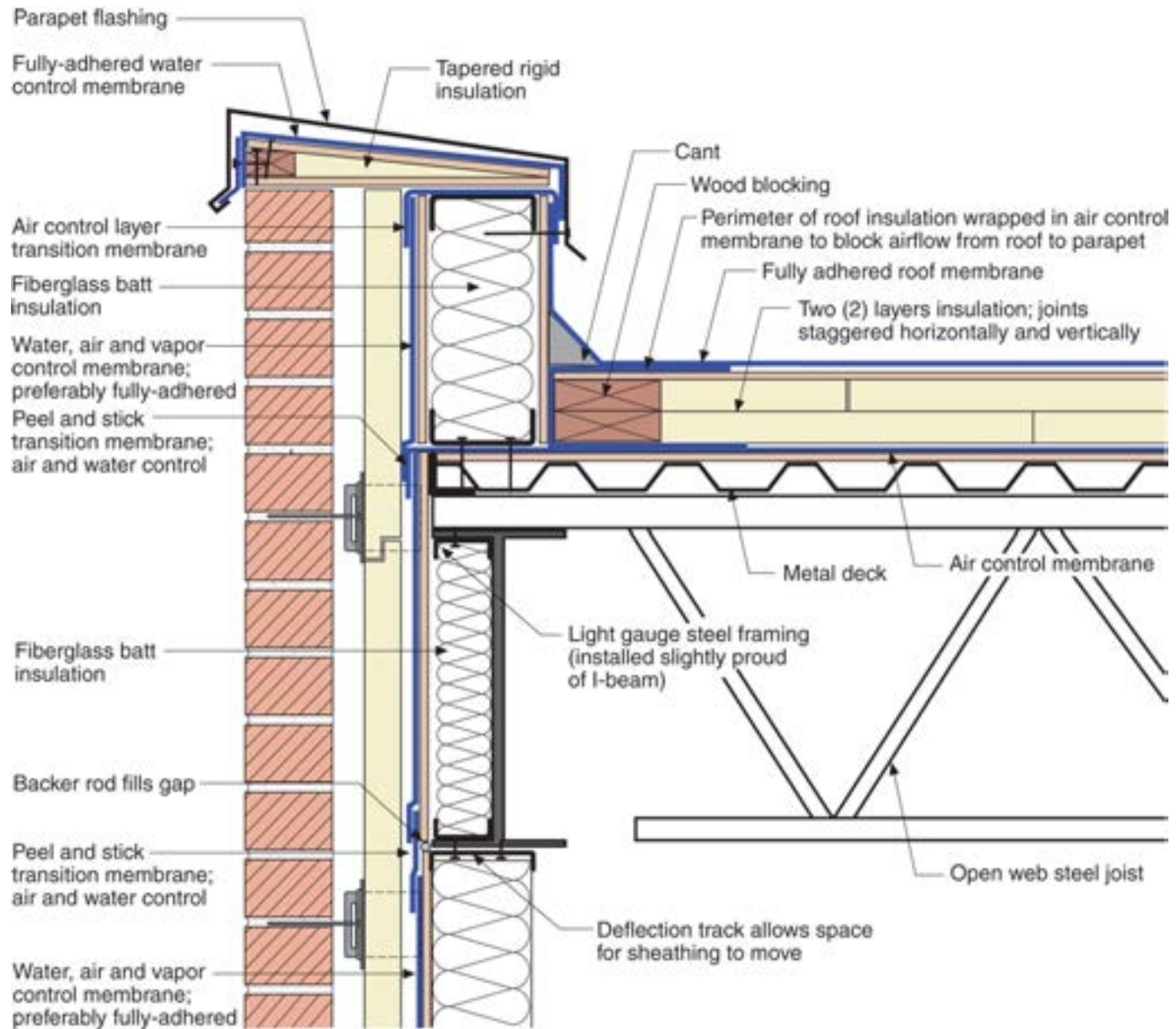

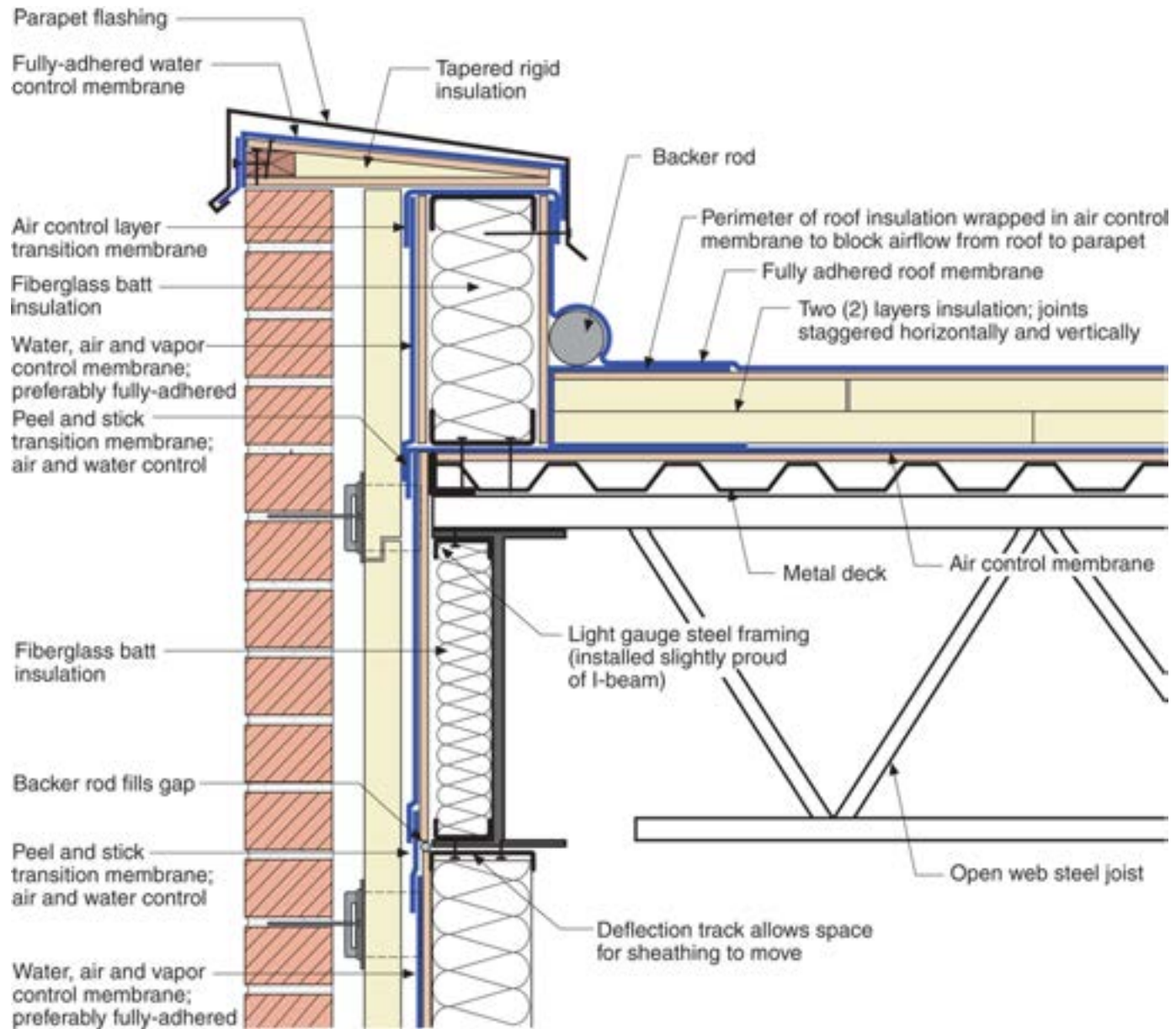

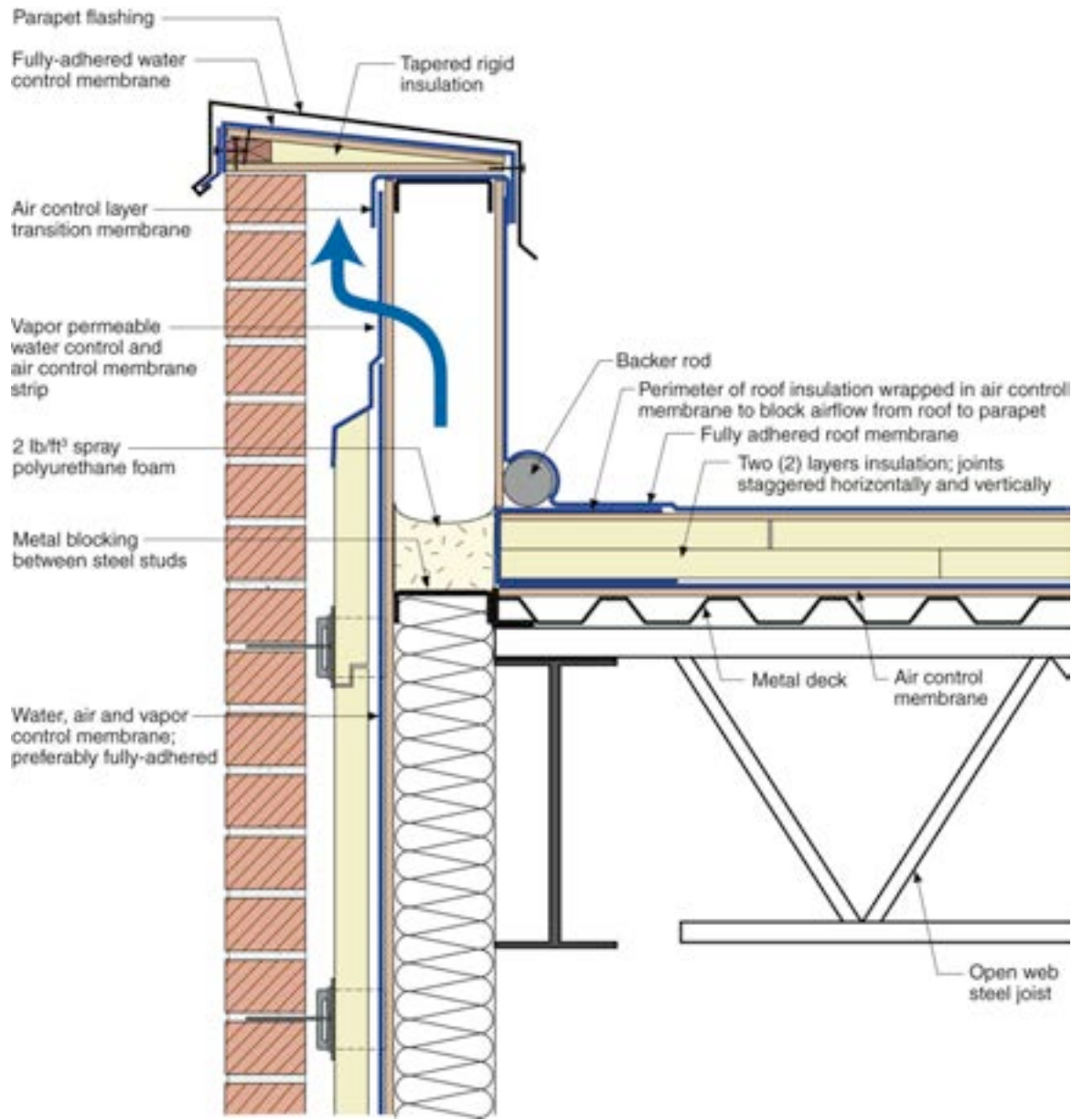

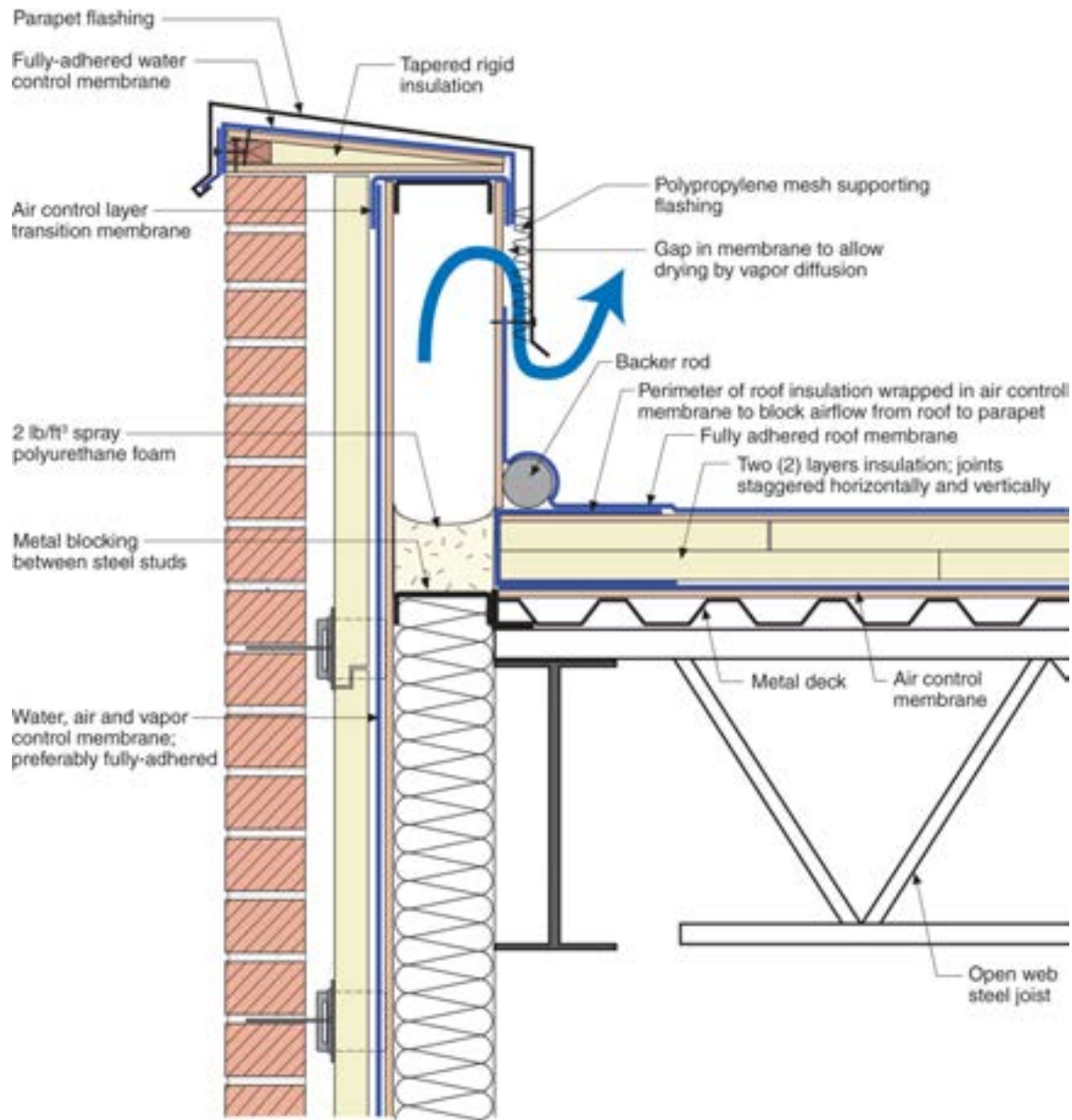

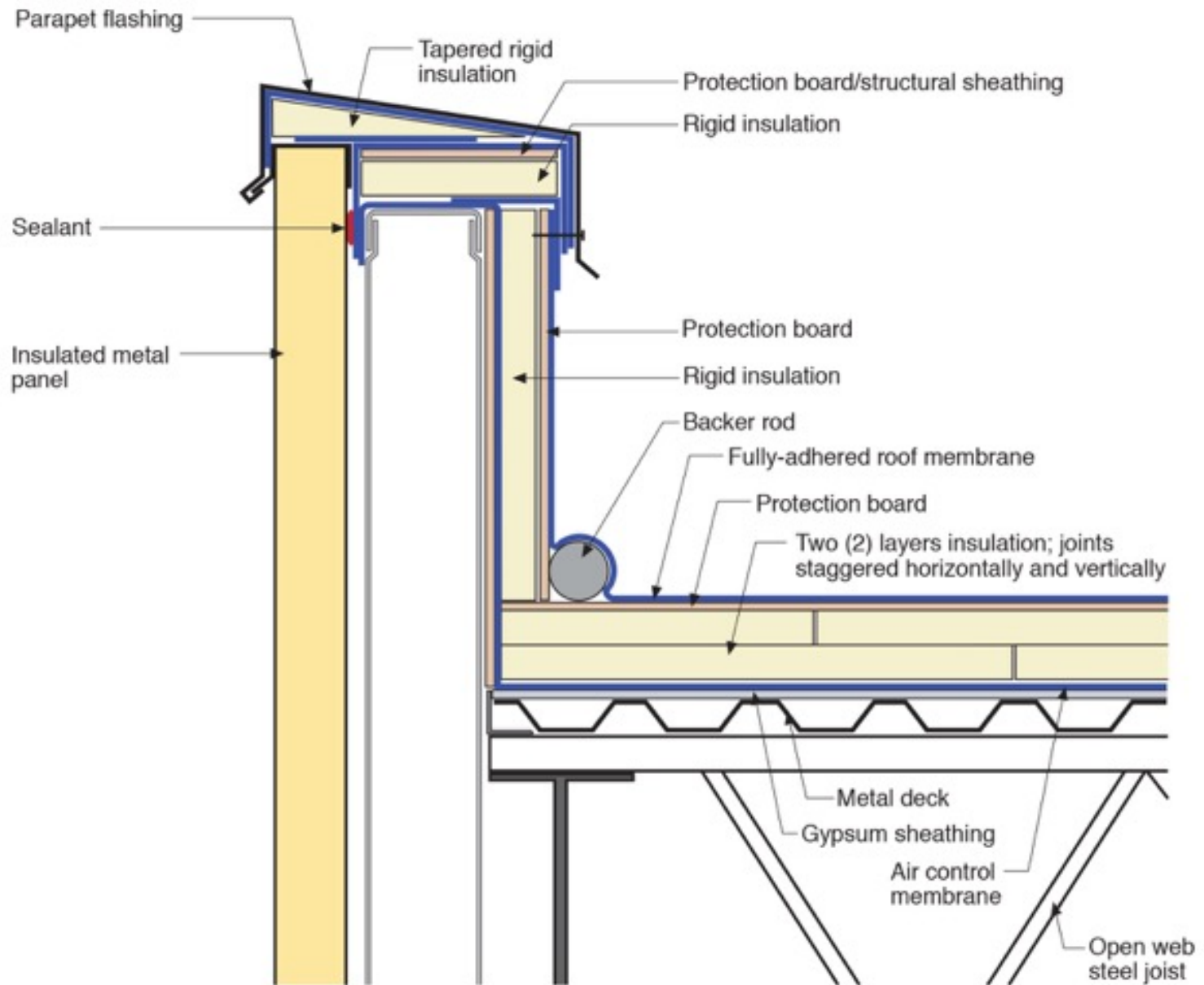

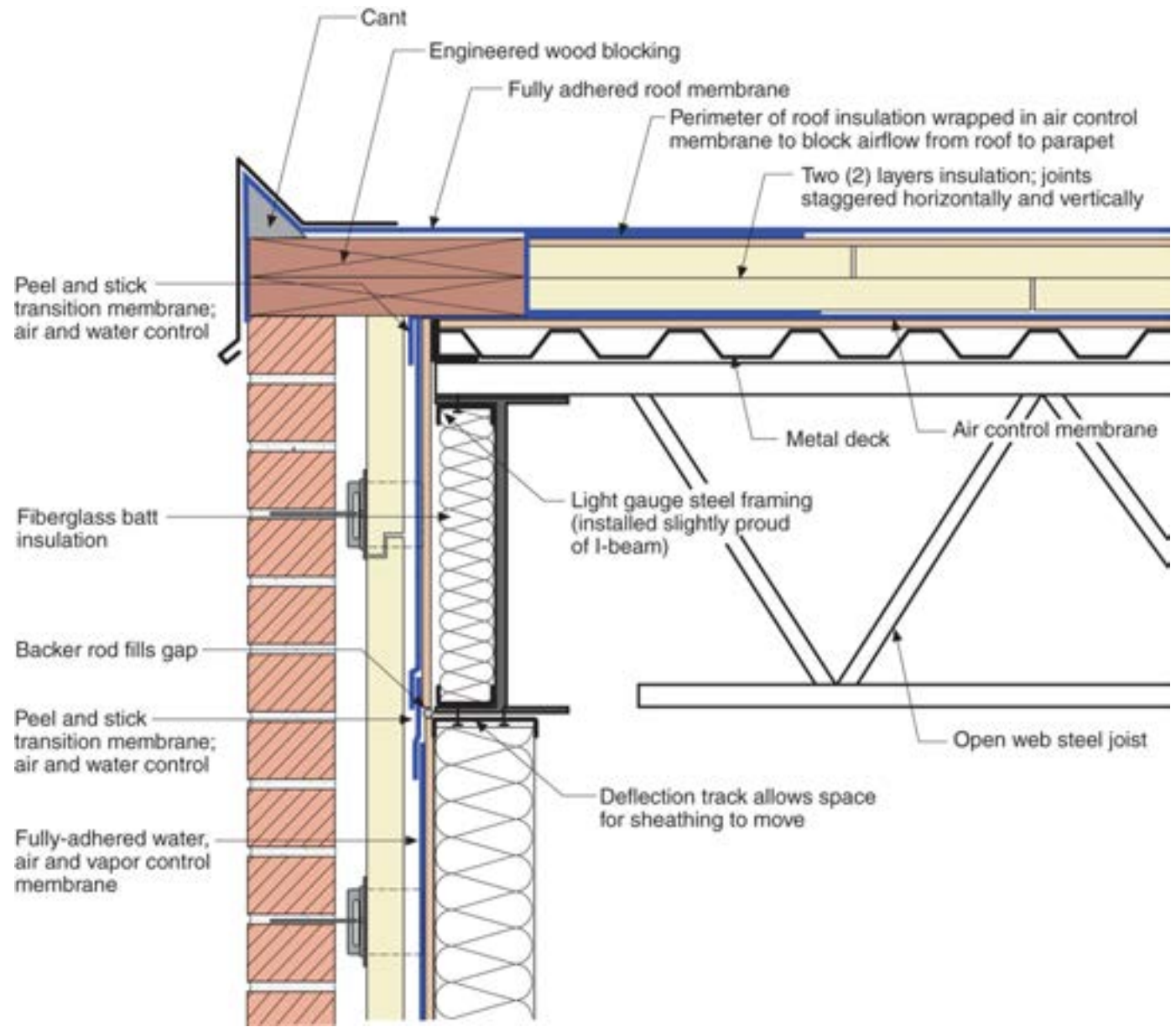

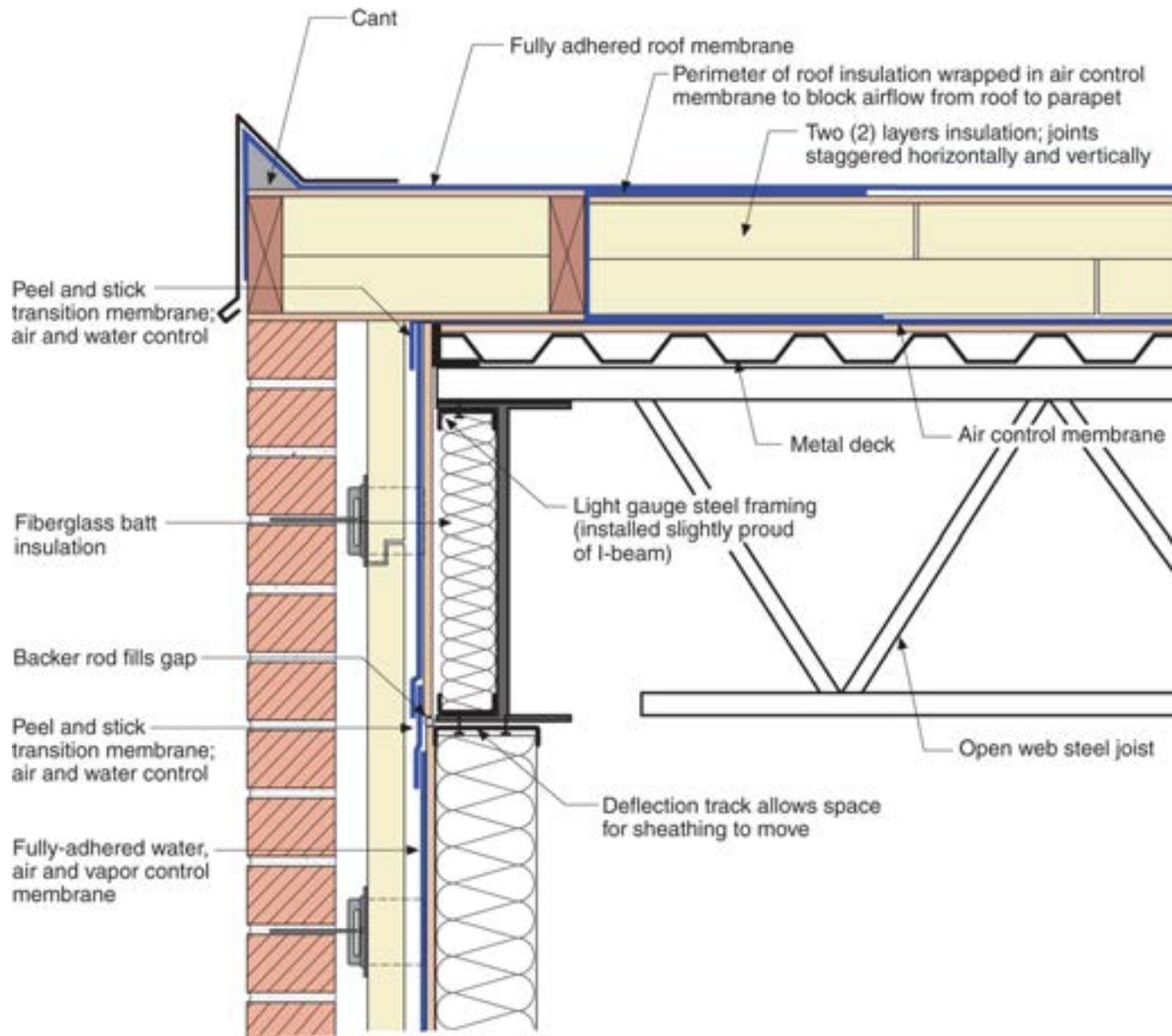

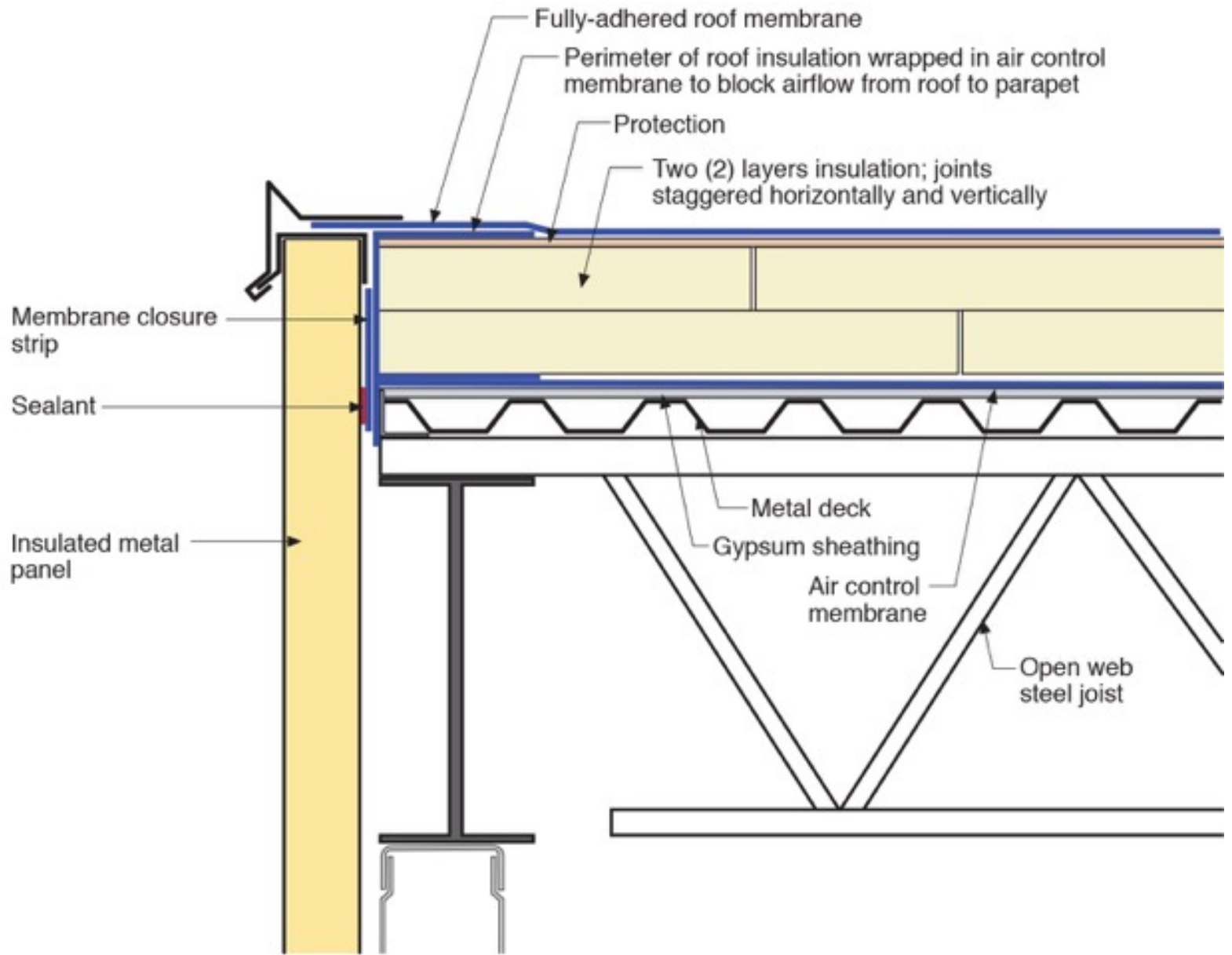

It's a Case of Black or White

It's a Case of Black or White Arrhenius

It's a Case of Black or White

Arrhenius

Every 10 degrees C – double the “badness”

Supply air into occupied zone returns to AHU by passing through deliberately porous dropped ceiling or through return grilles installed in dropped ceiling

Air handling unit extracts air from dropped ceiling, conditions it and injects it into the occupied zones via supply ductwork

Dropped ceiling depressurized by air handling units extracting air from dropped ceiling

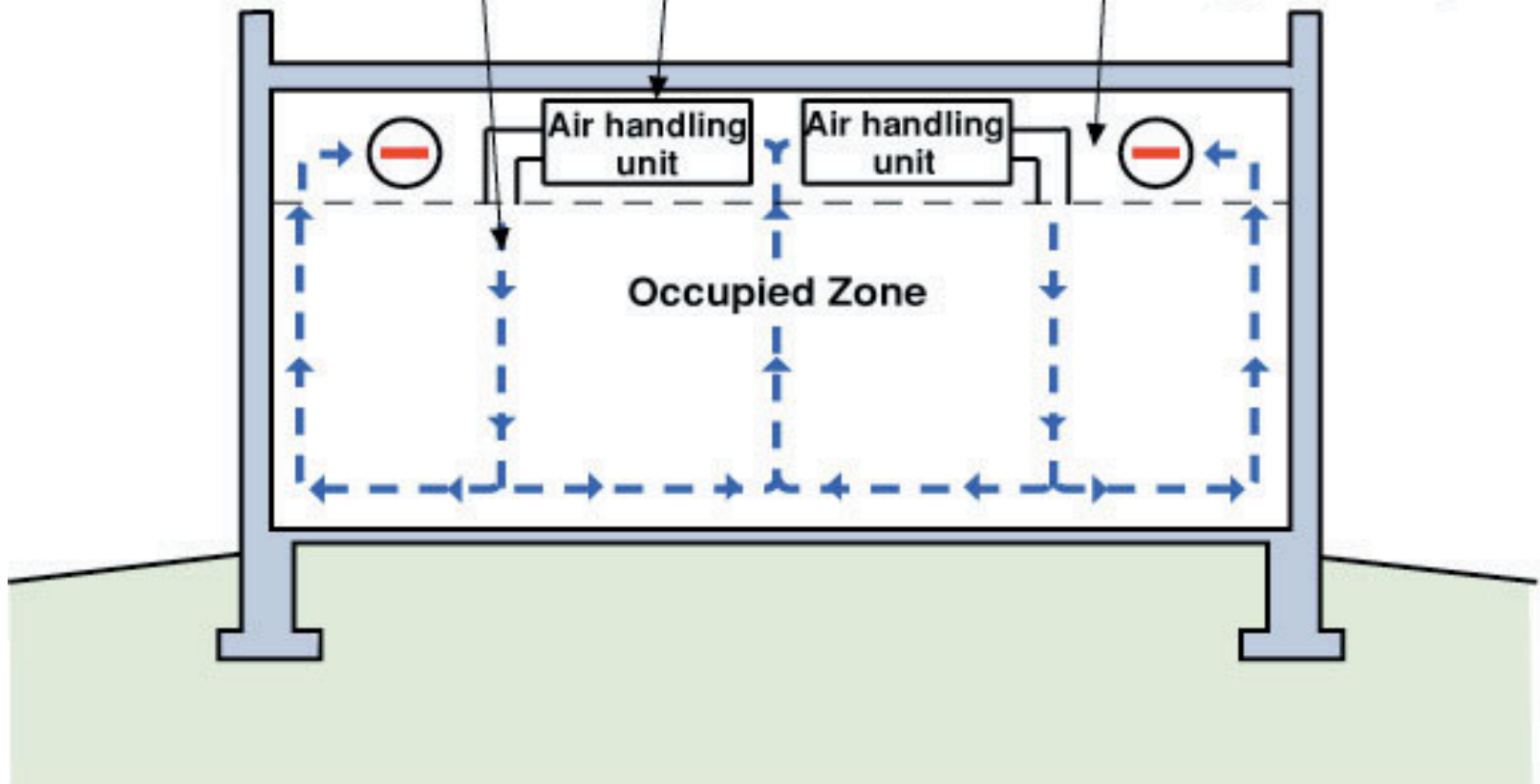

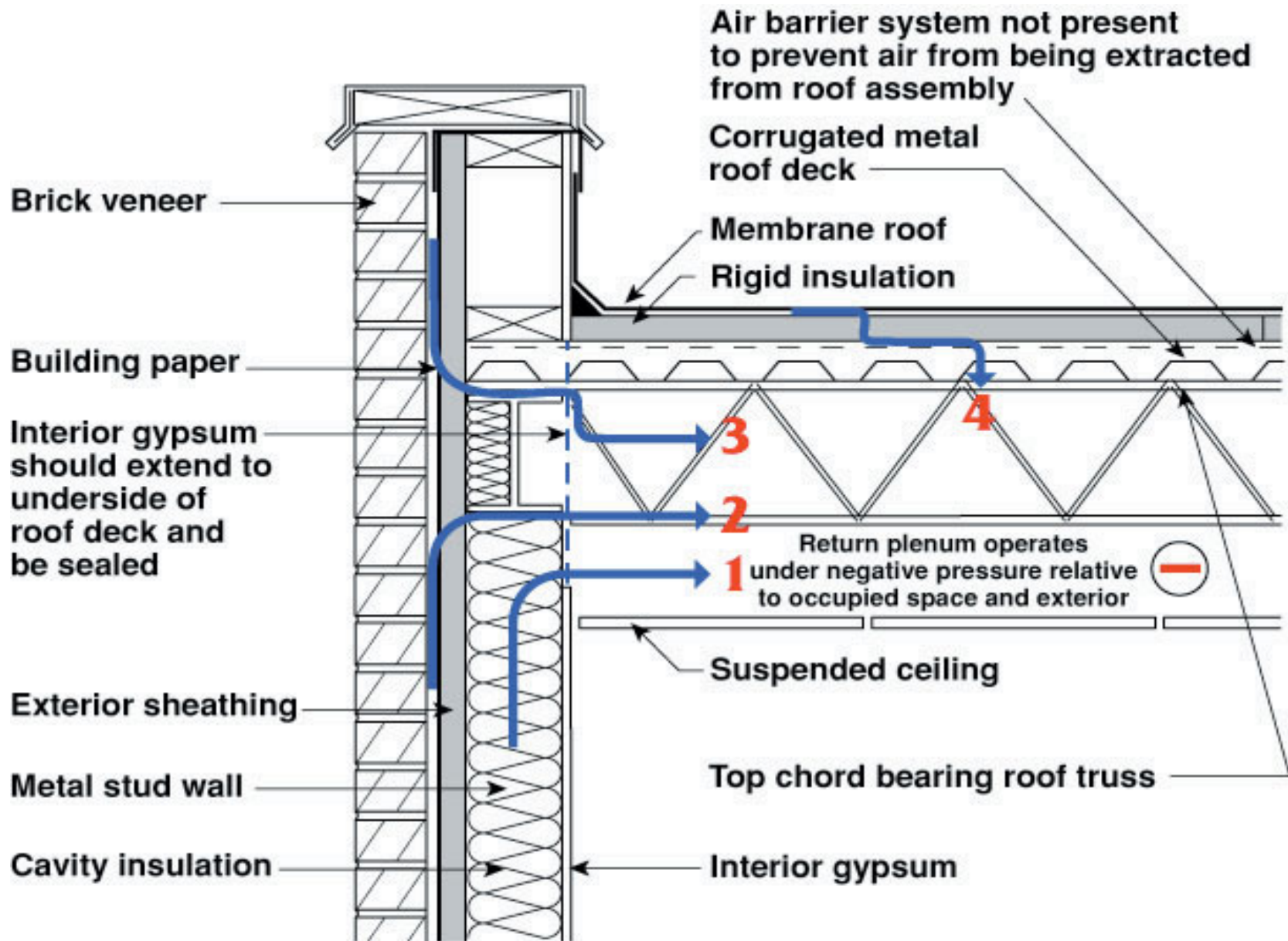

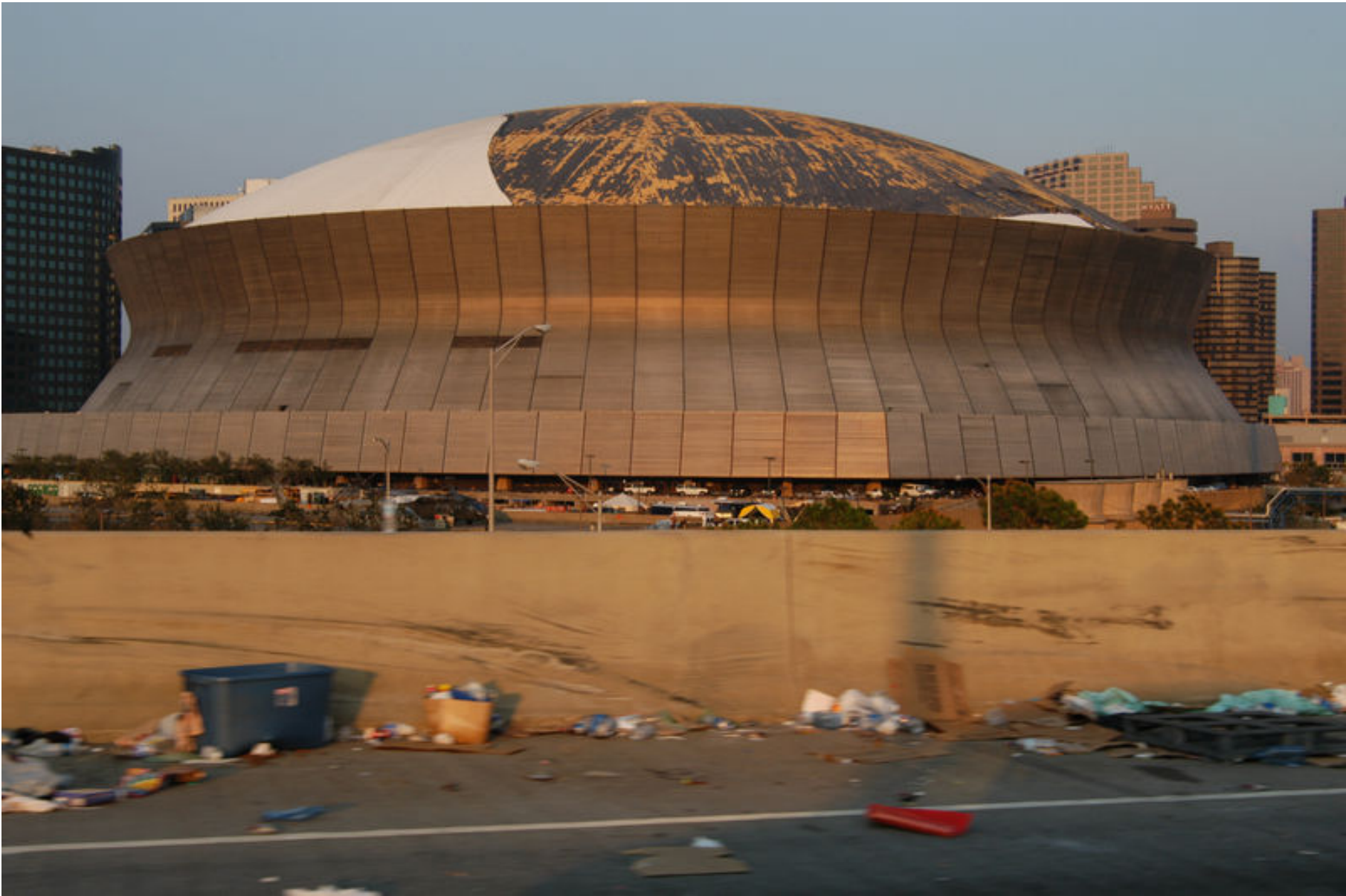

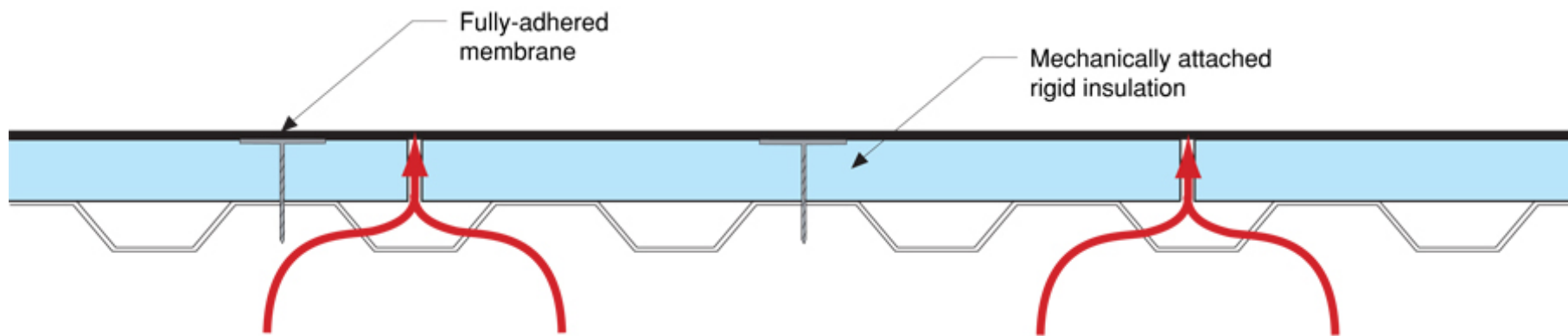



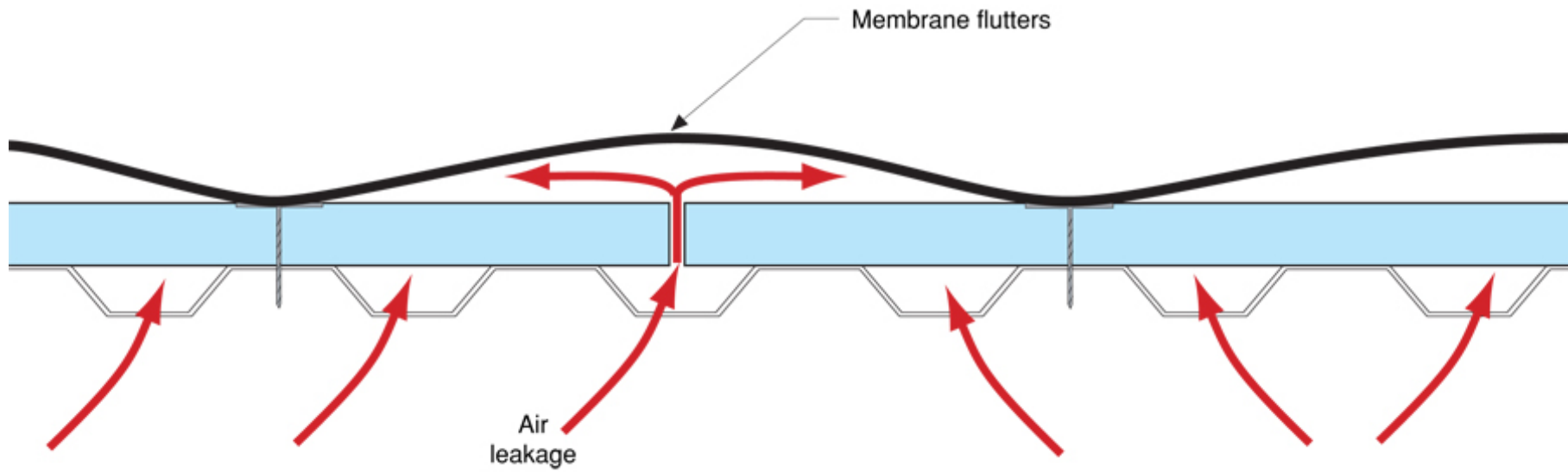









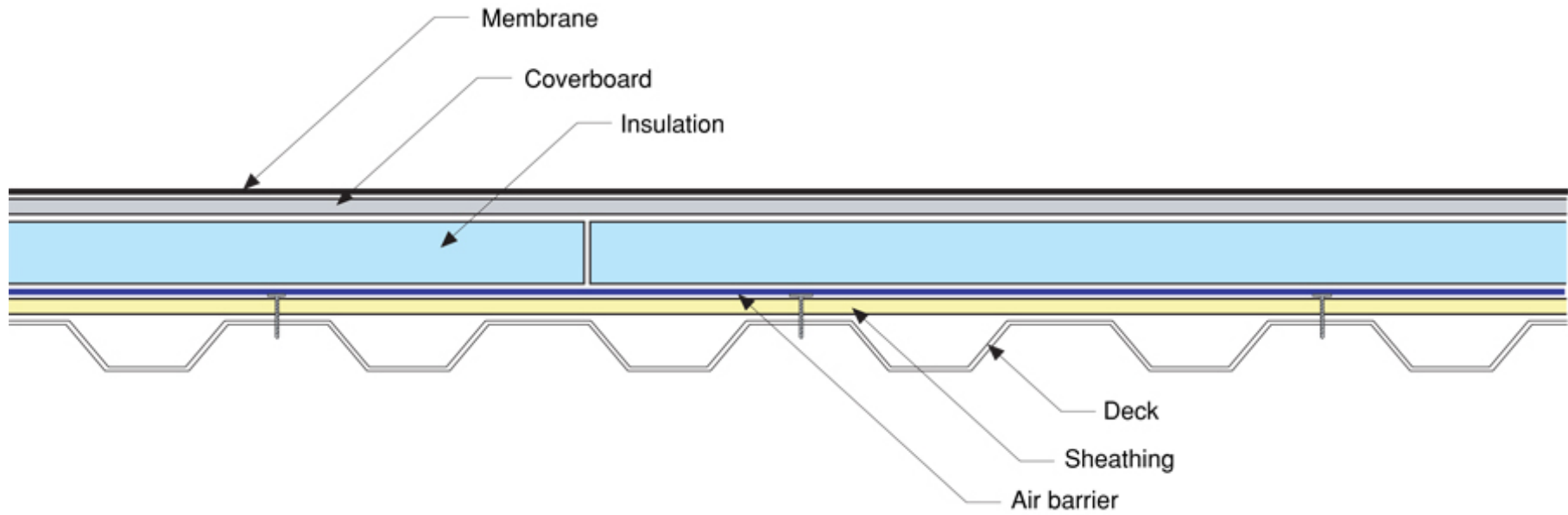



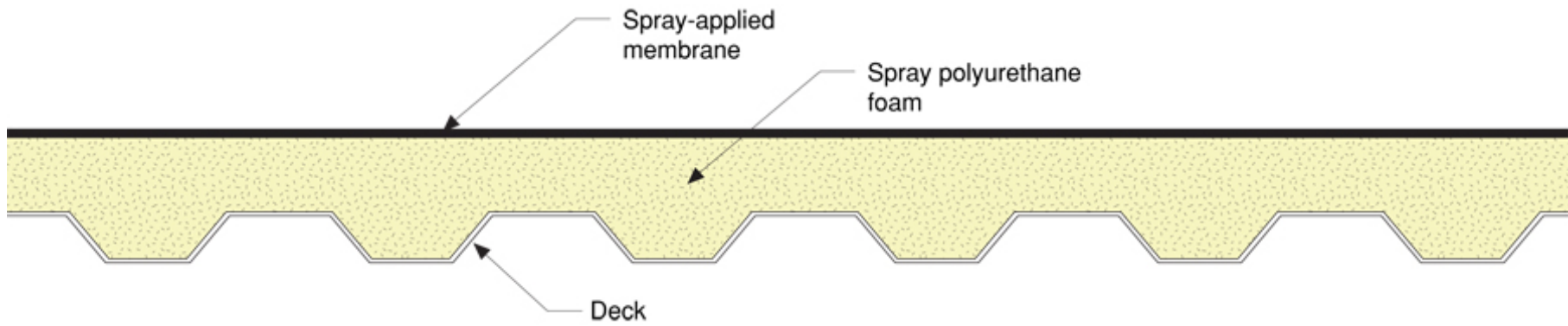



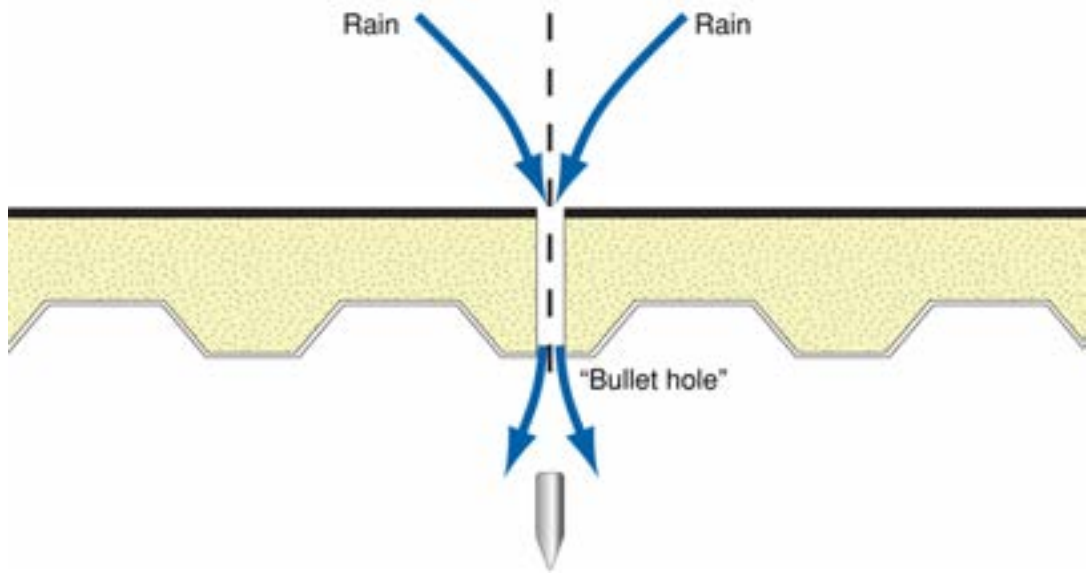
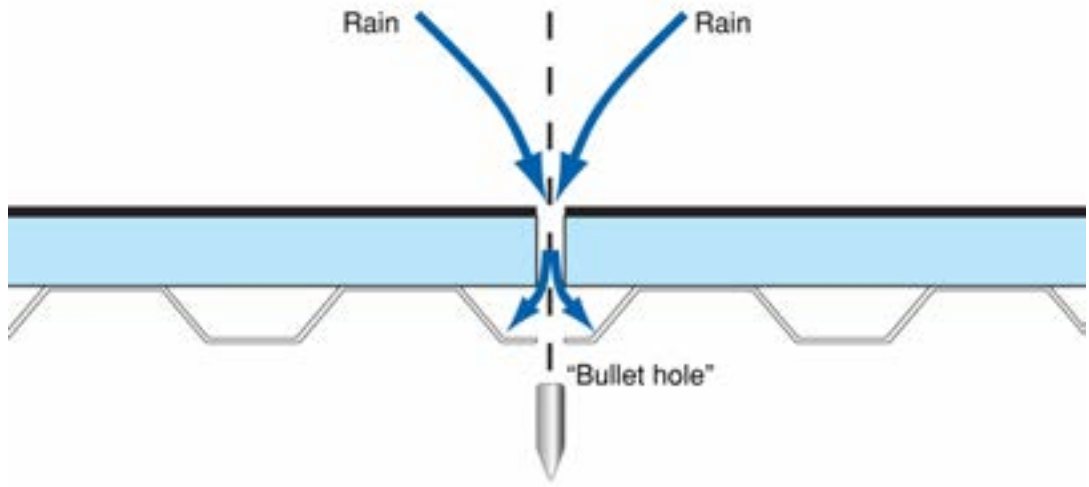







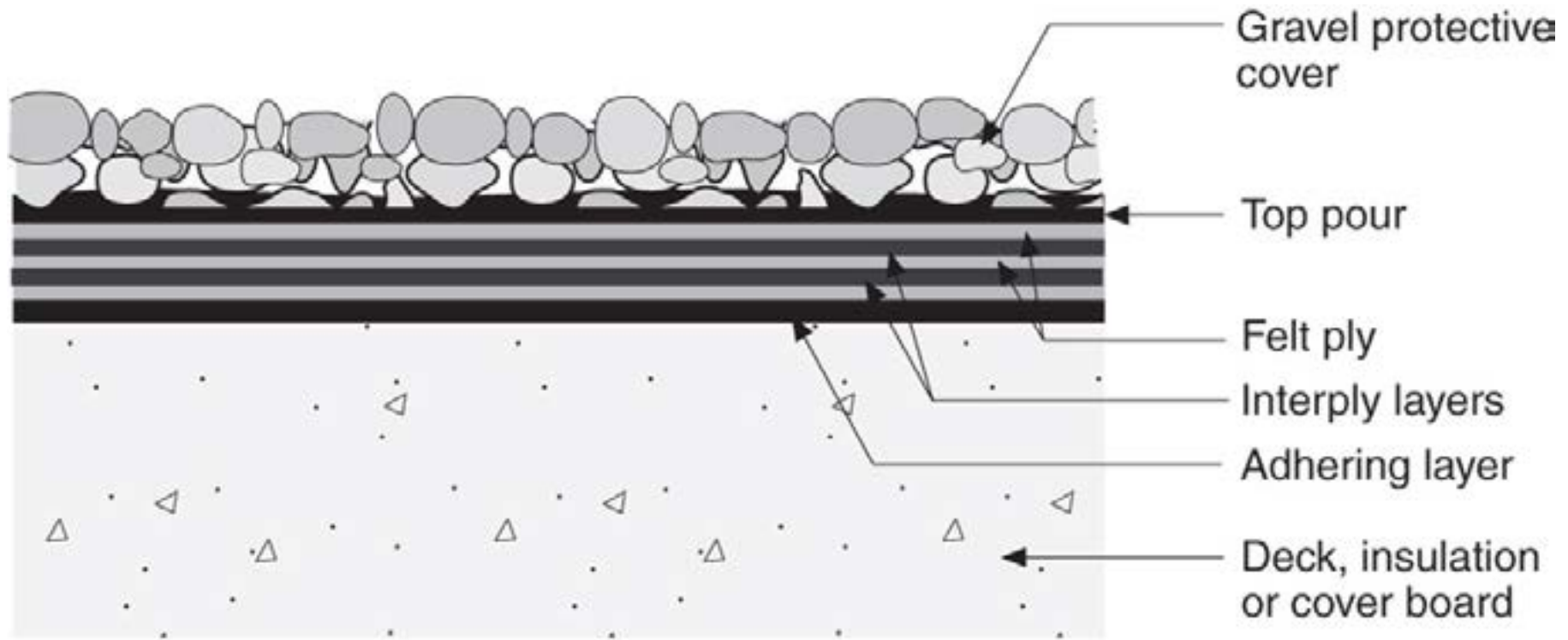

From Baker, M.; Roofs, 1980

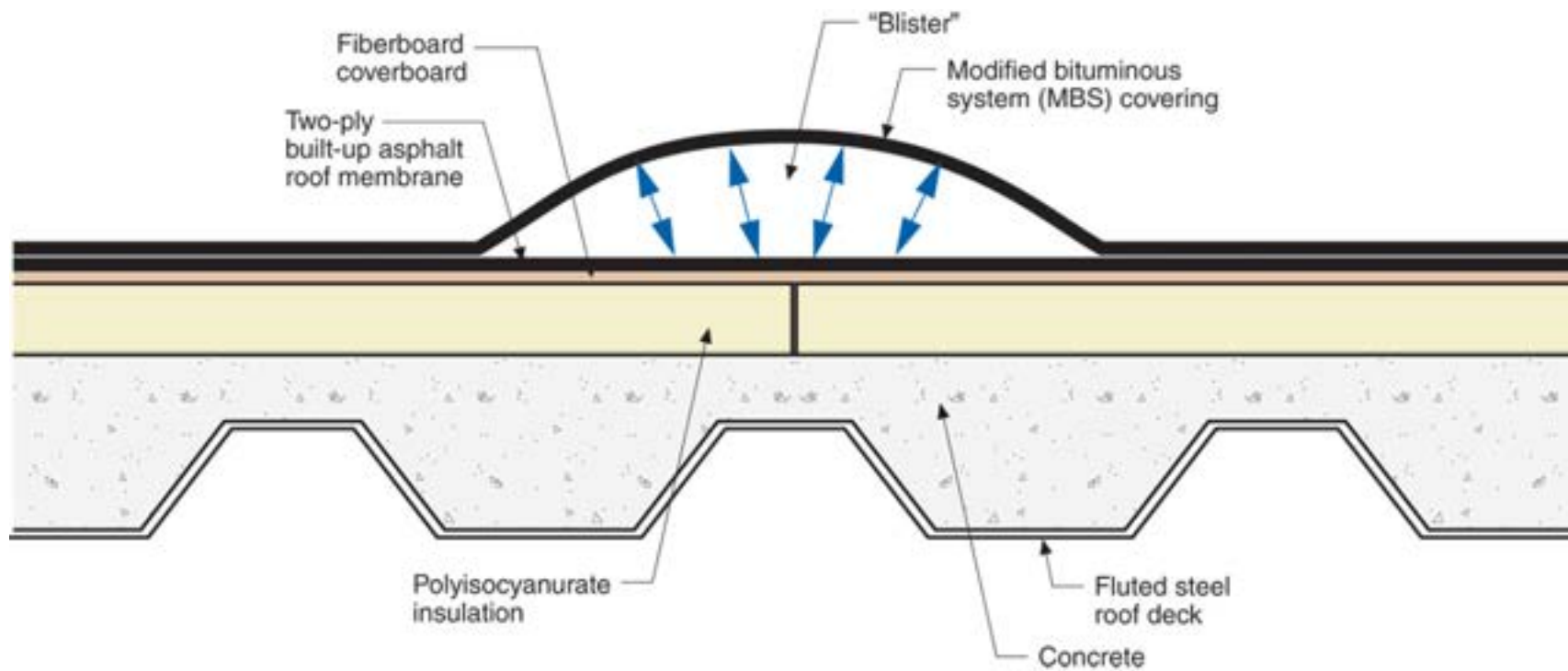

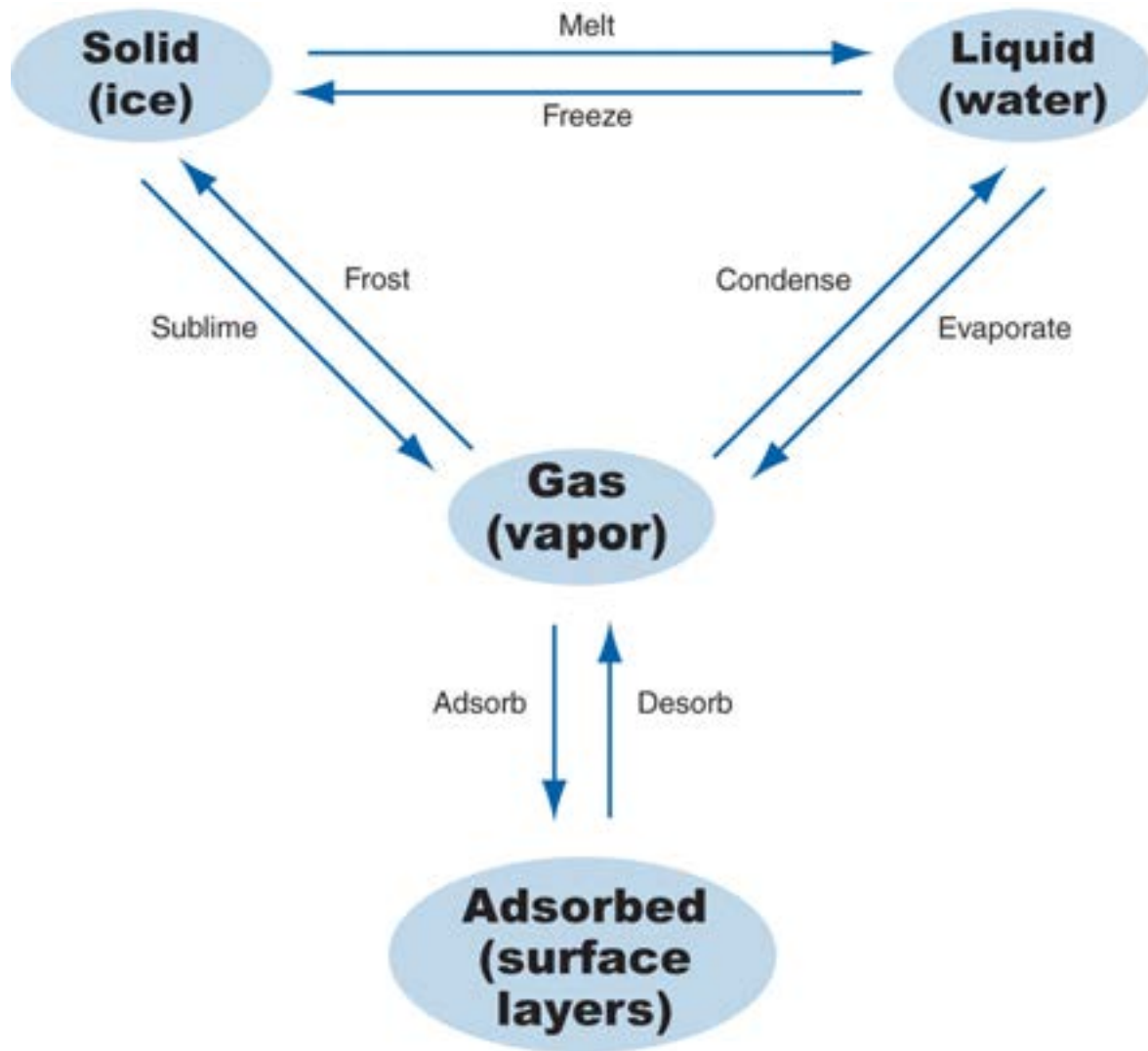

Moisture Transport in Porous Media

Phase	Transport Process	Driving Potential
Vapor	Diffusion	Vapor Concentration
Adsorbate	Surface Diffusion	Concentration
Liquid	Capillary Flow	Suction Pressure
	Osmosis	Solute Concentration

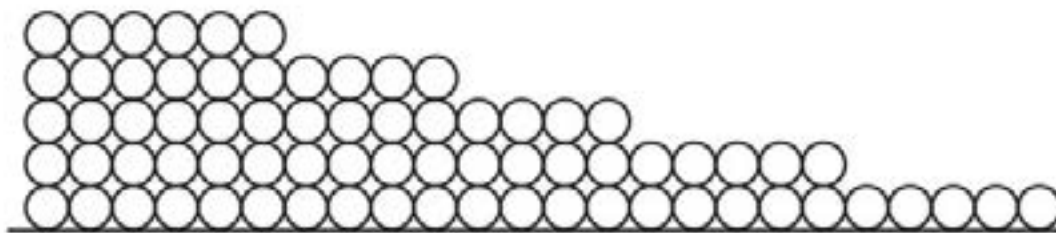

Monolayers of adsorbed water increase with increasing RH

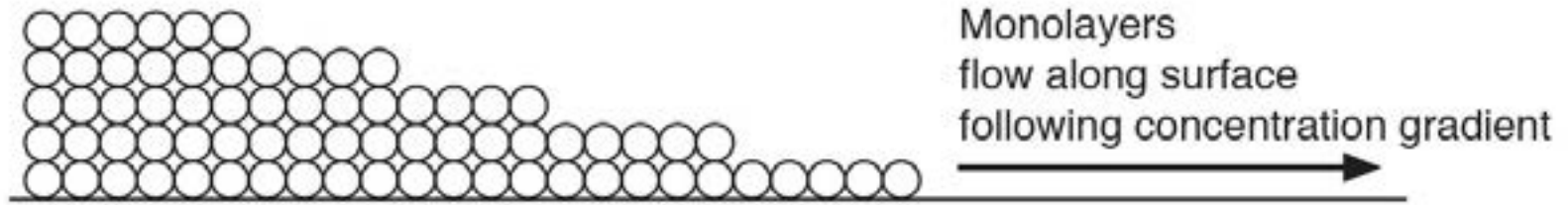

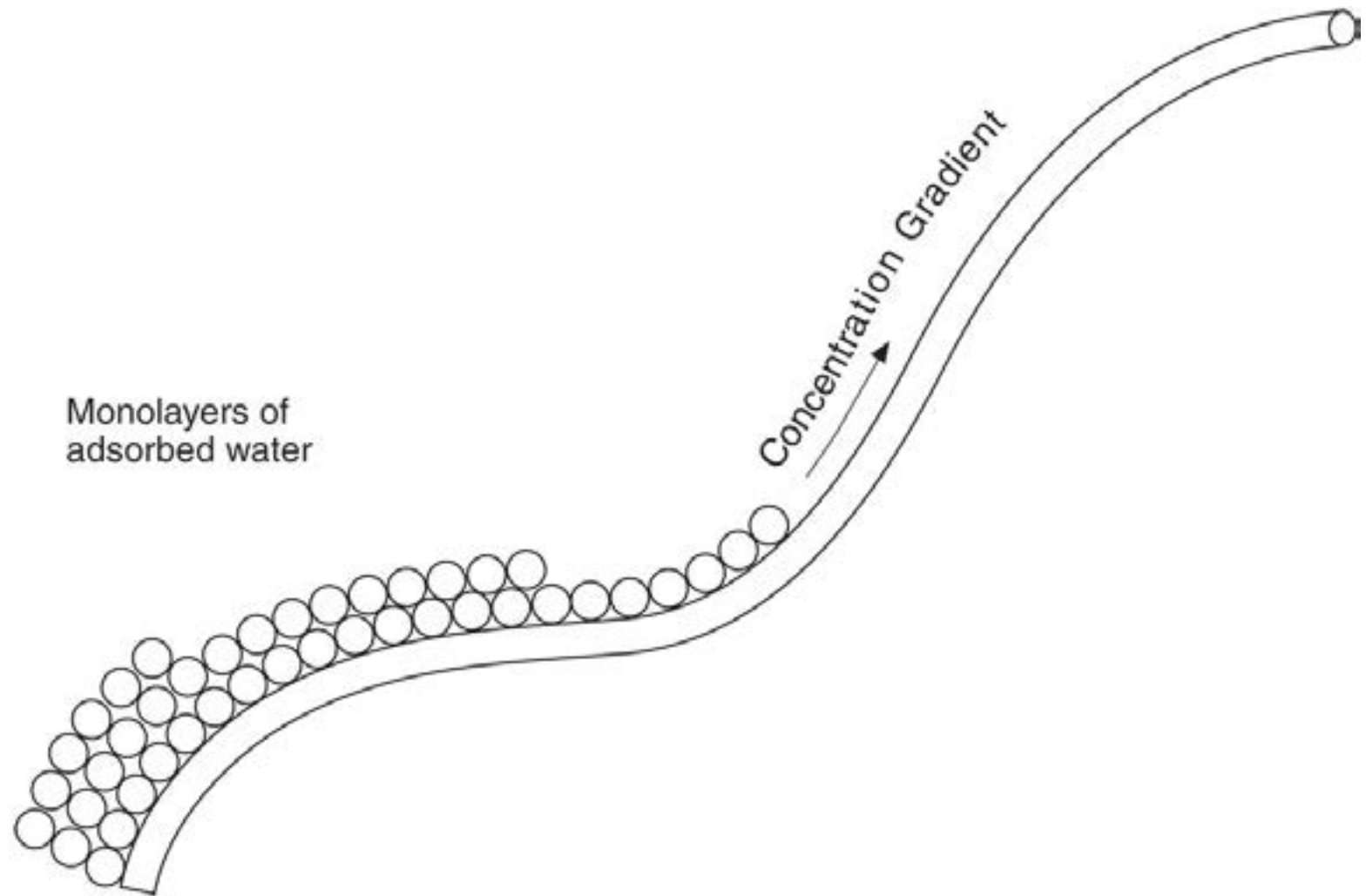

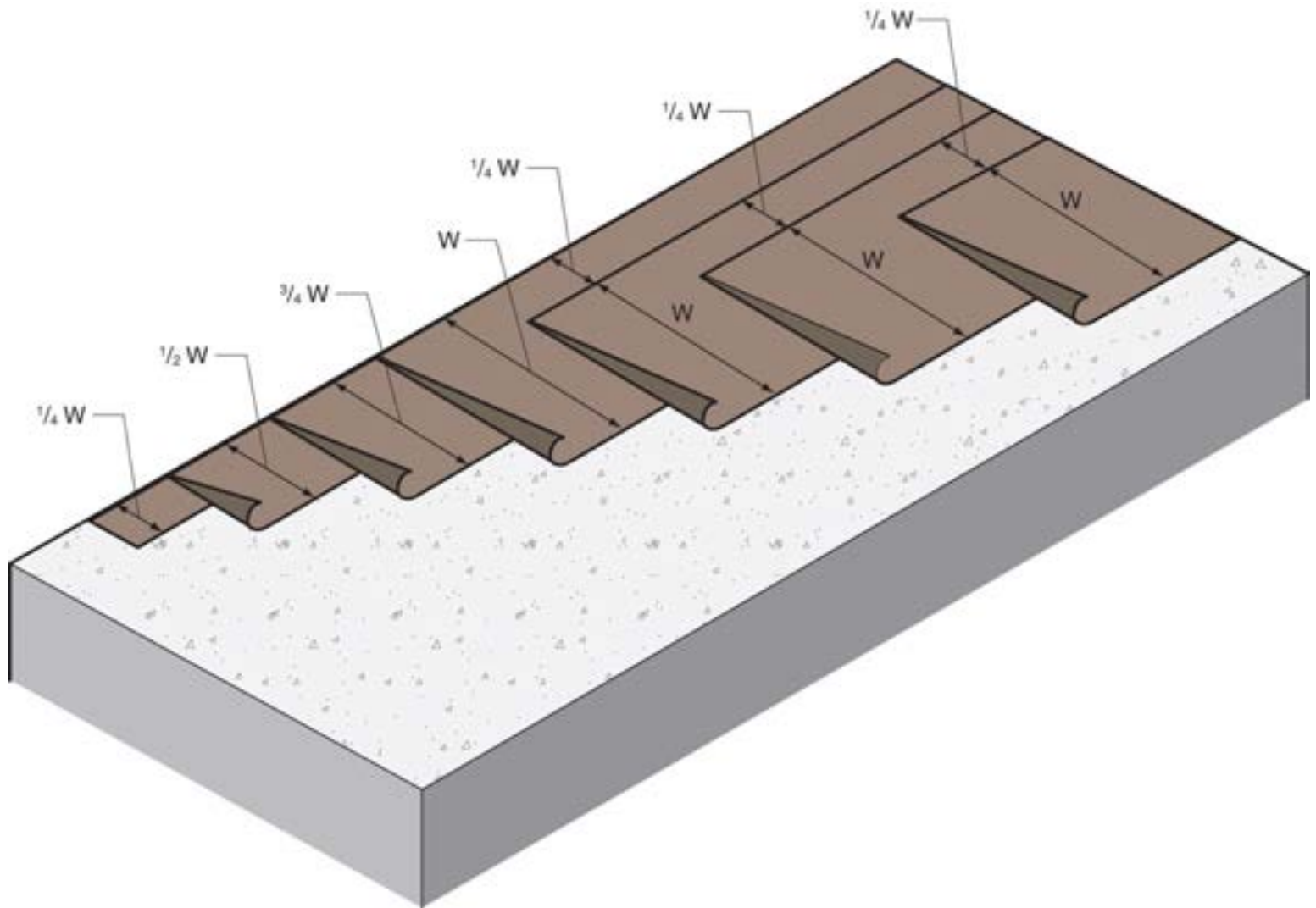

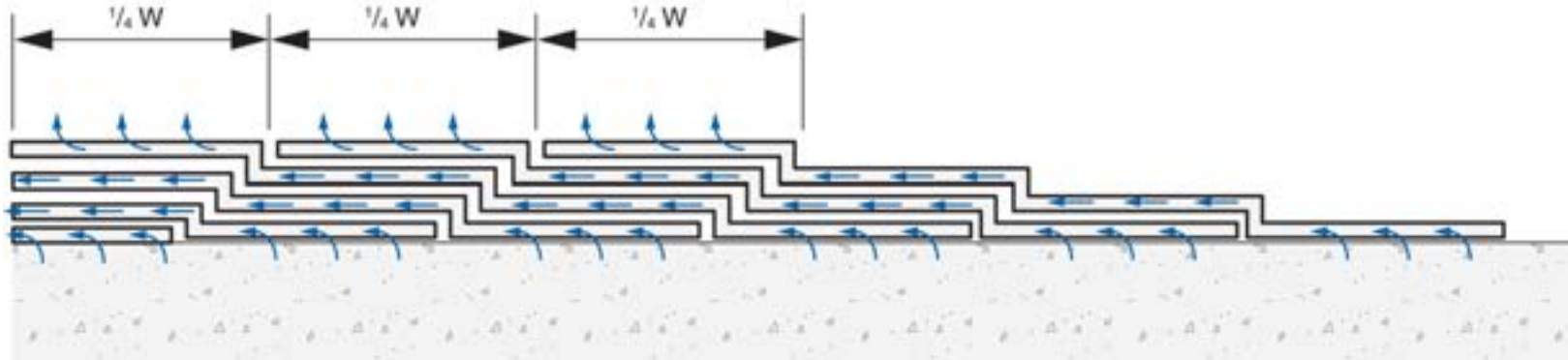







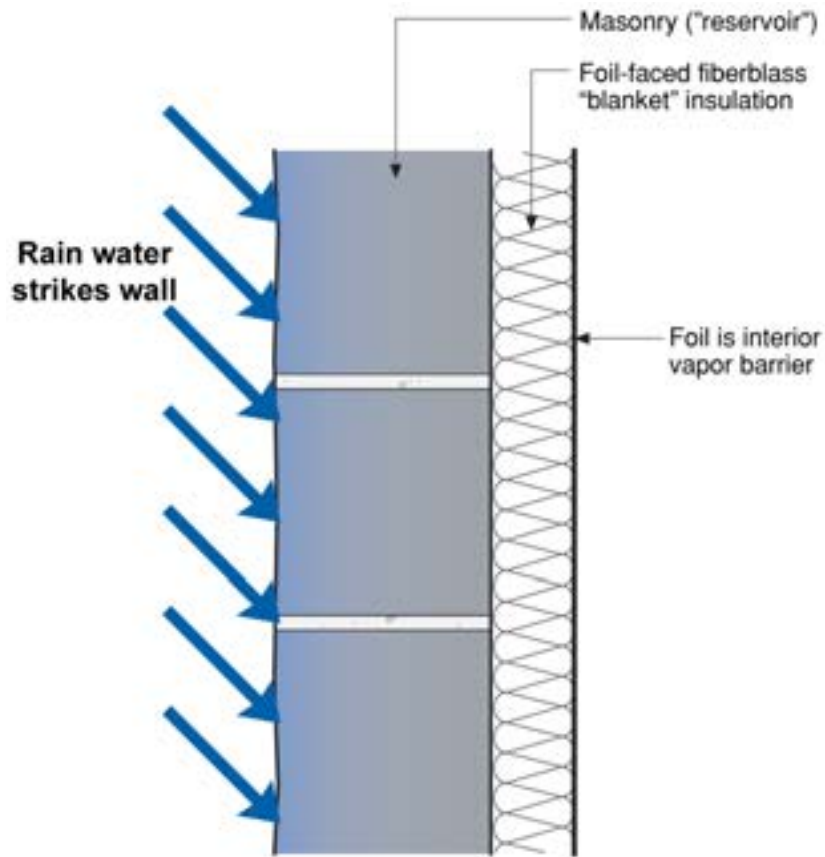

1.

- Rain water is deposited on exterior face of masonry
- Rain water enters masonry through paint layer

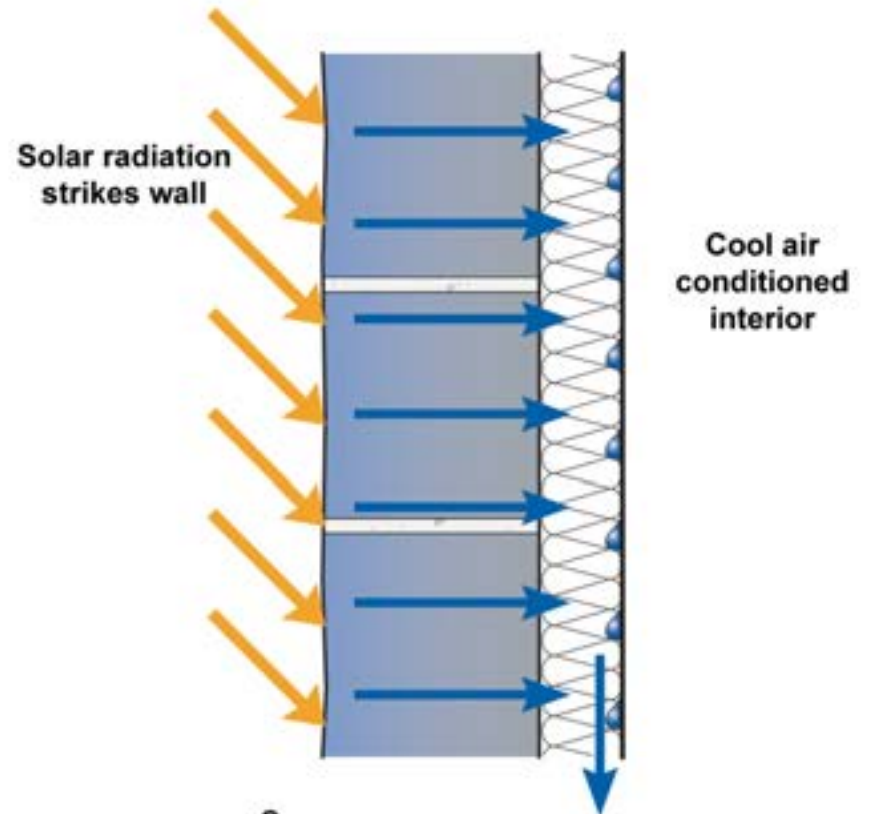

2.

- Solar radiation heats exterior while A/C cools interior
- Moisture is driven inward, condenses on foil vapor barrier and runs down wall

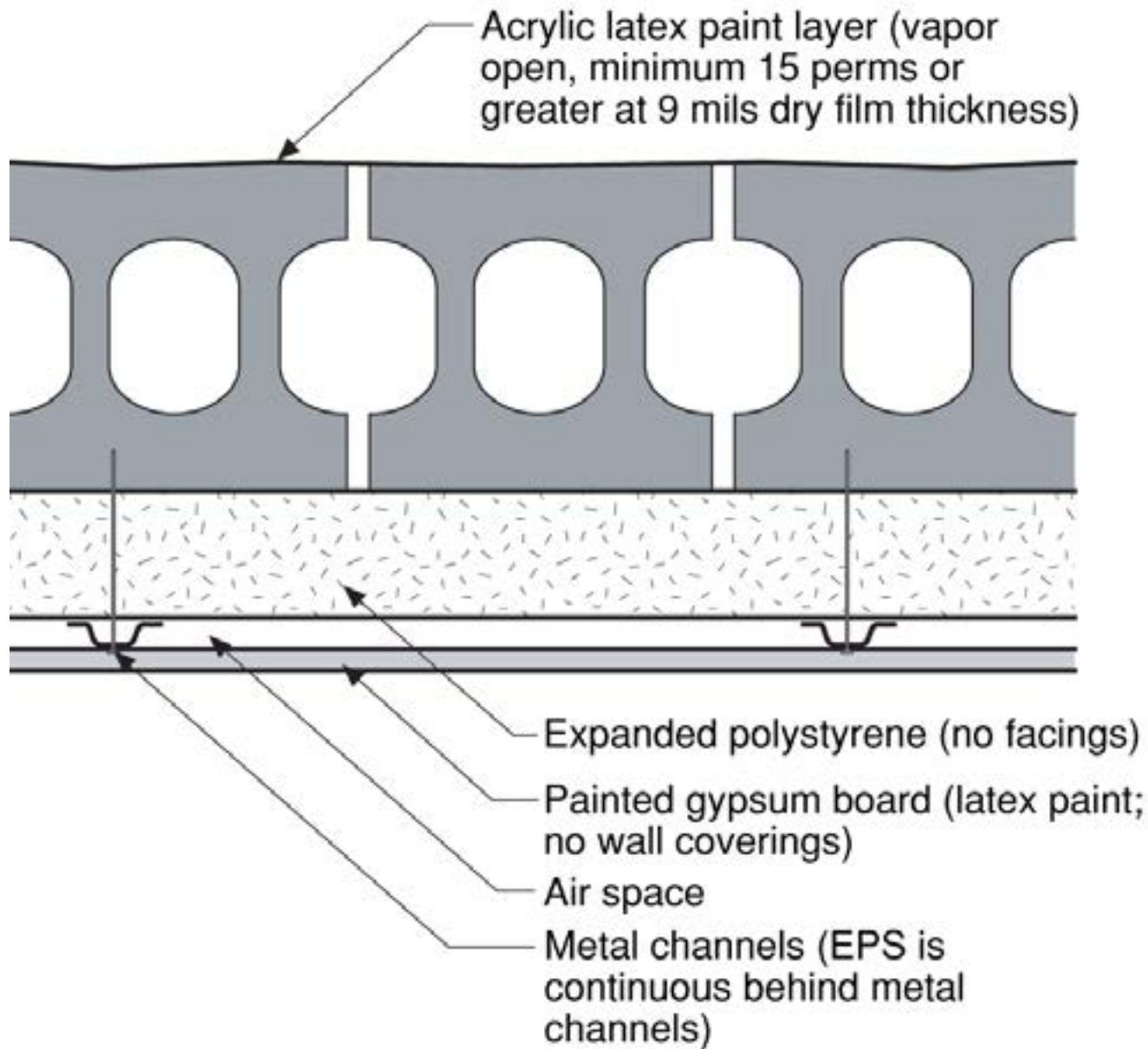

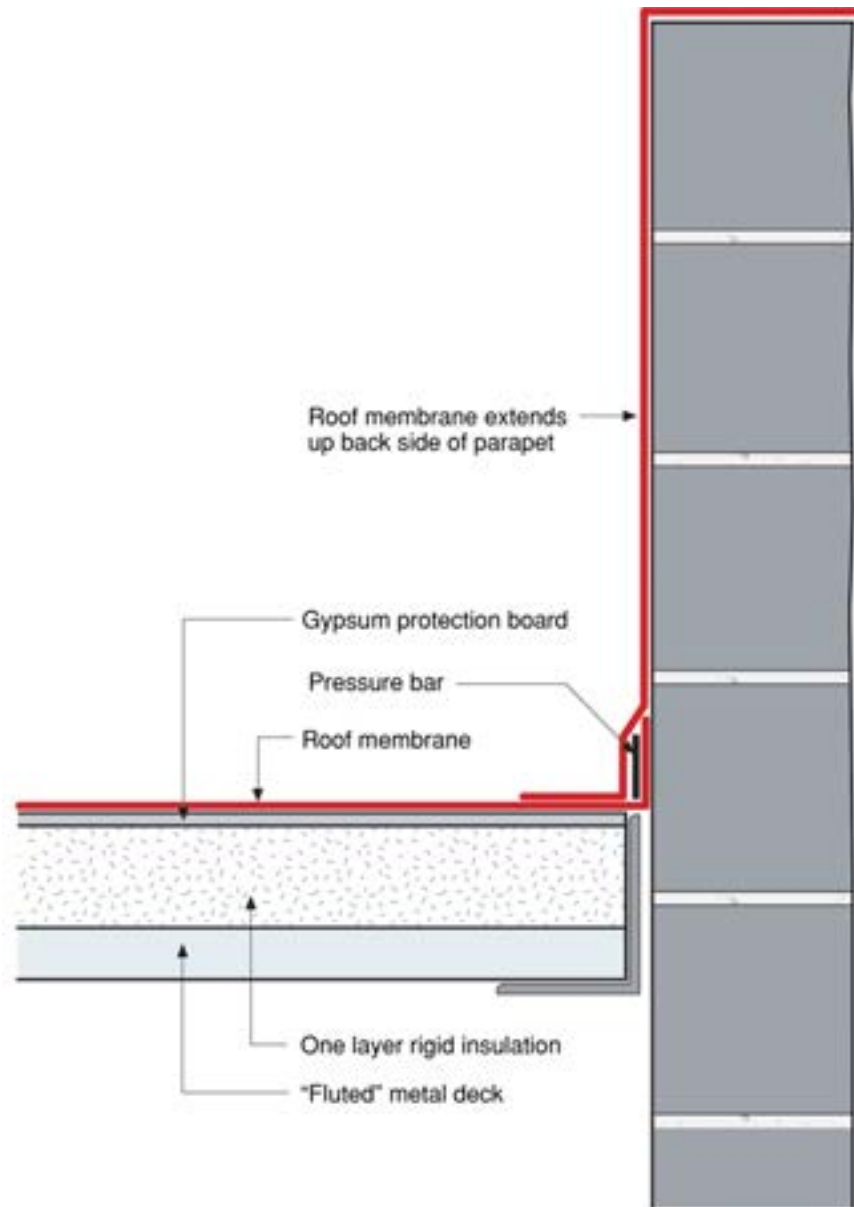

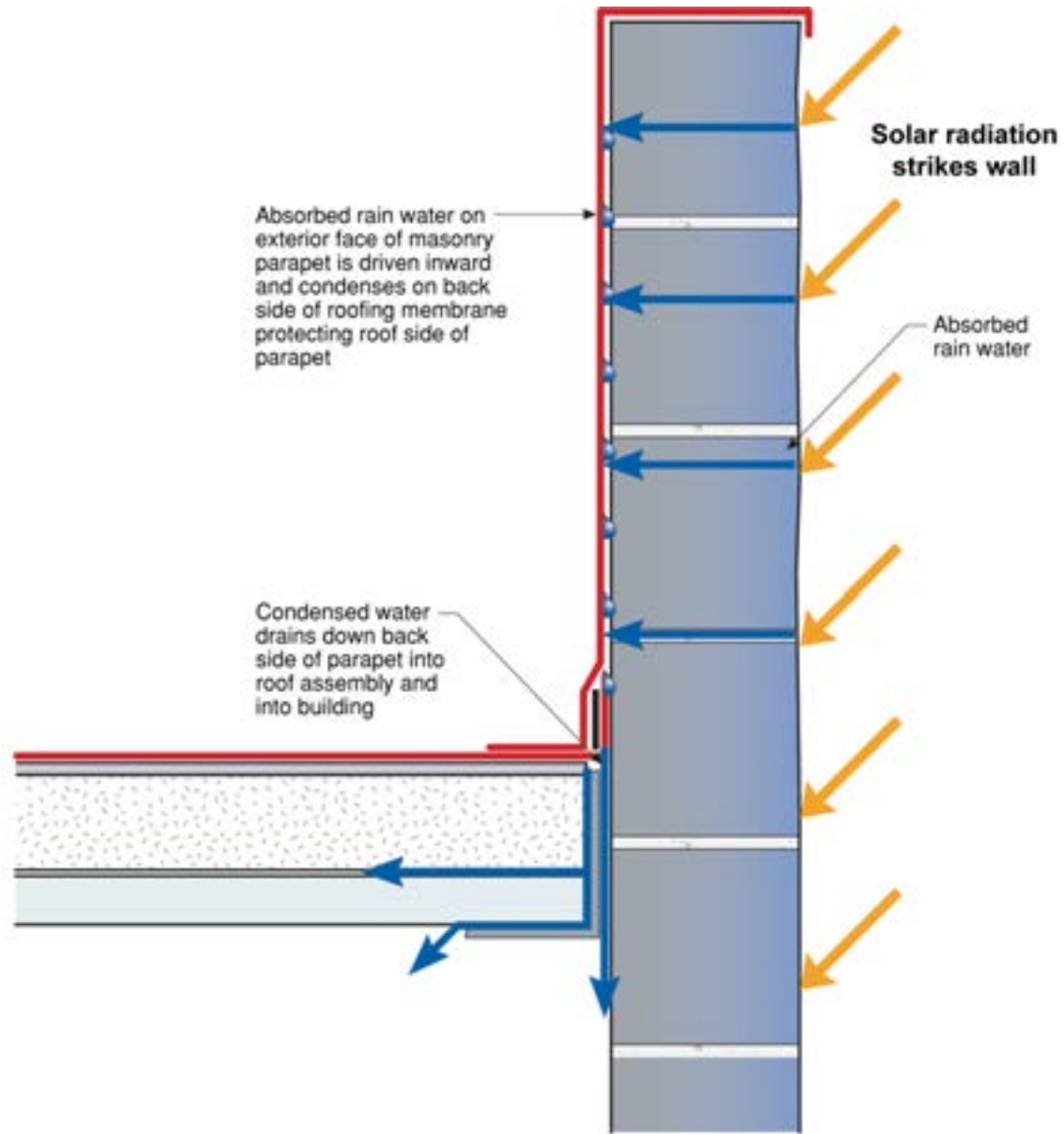

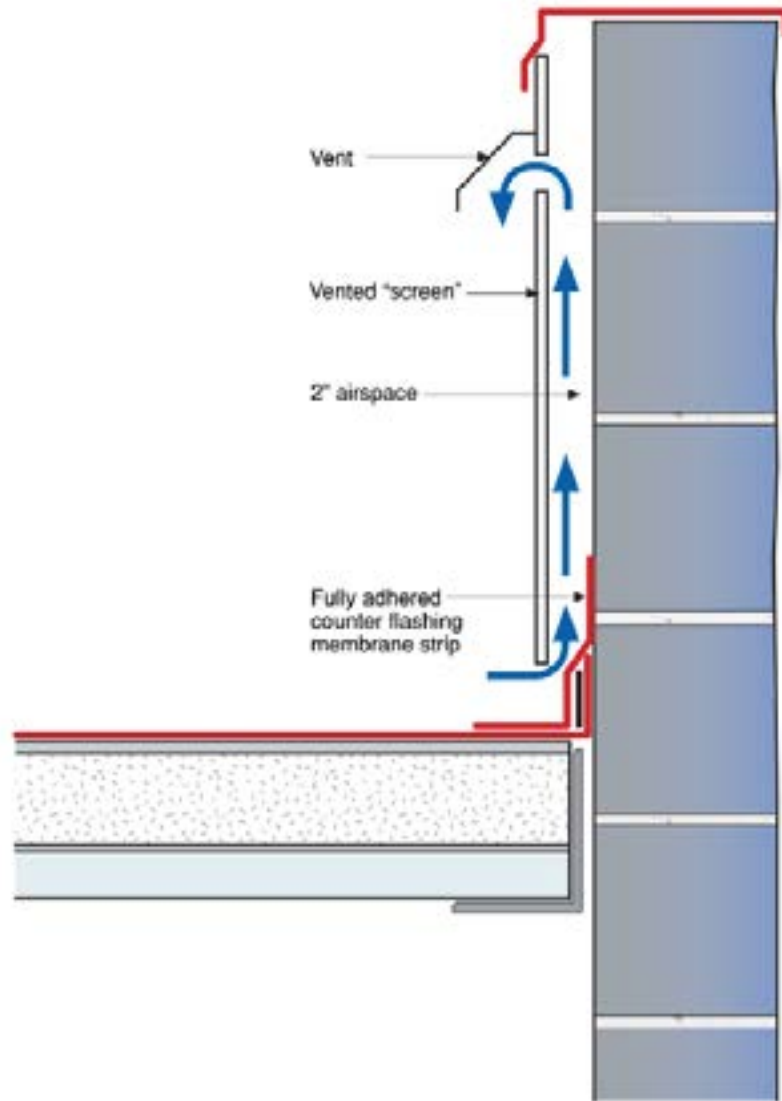

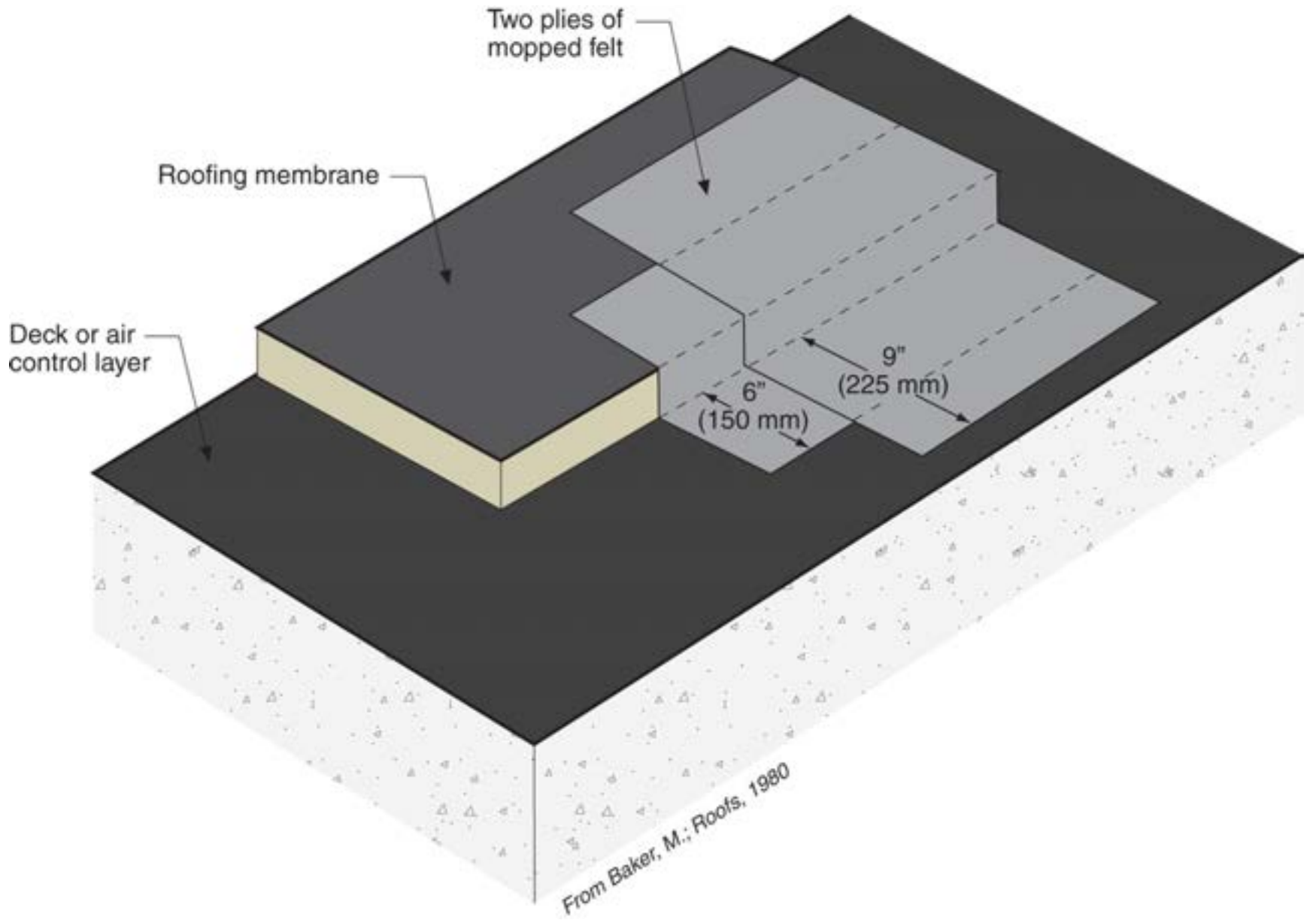

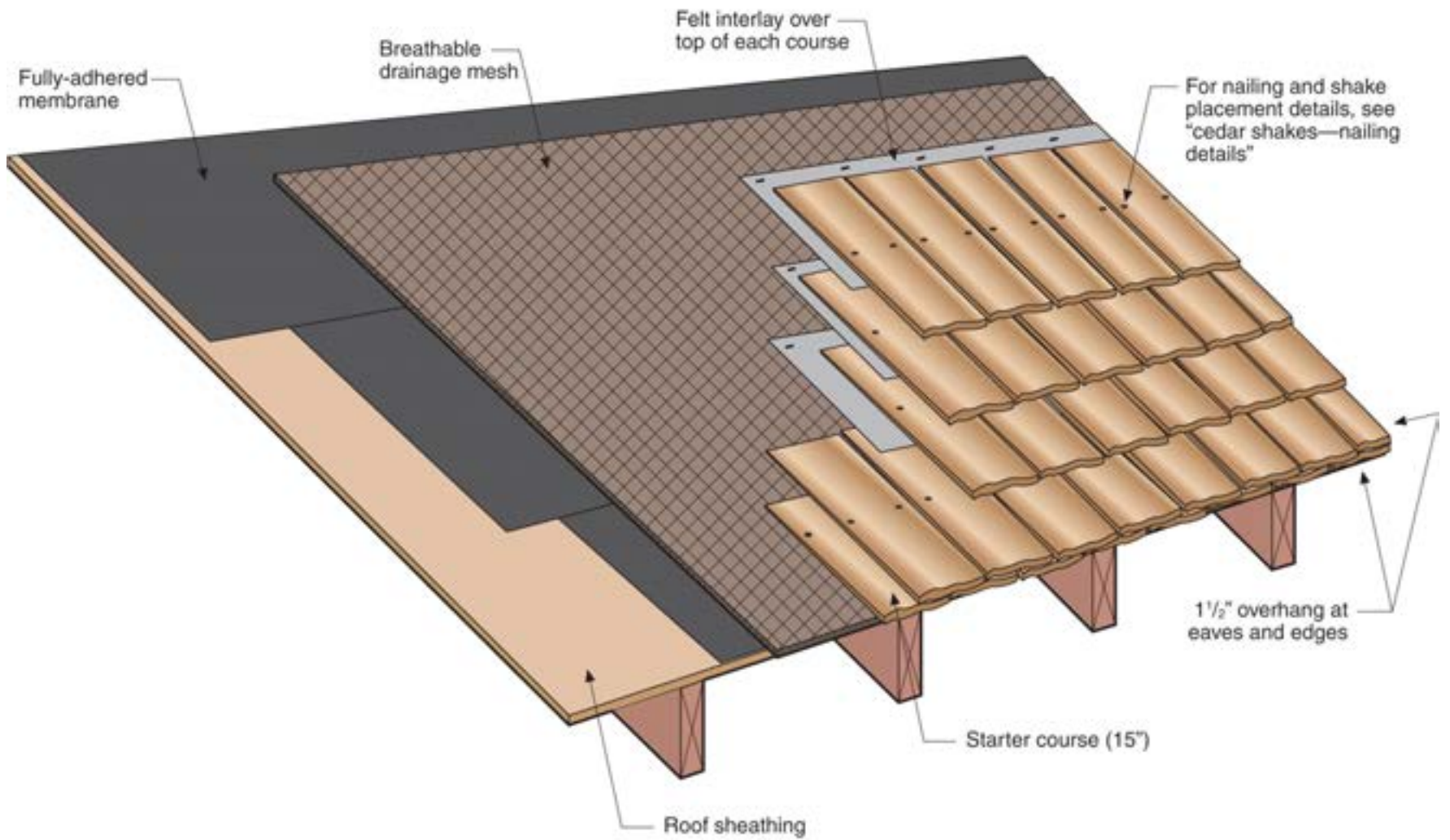

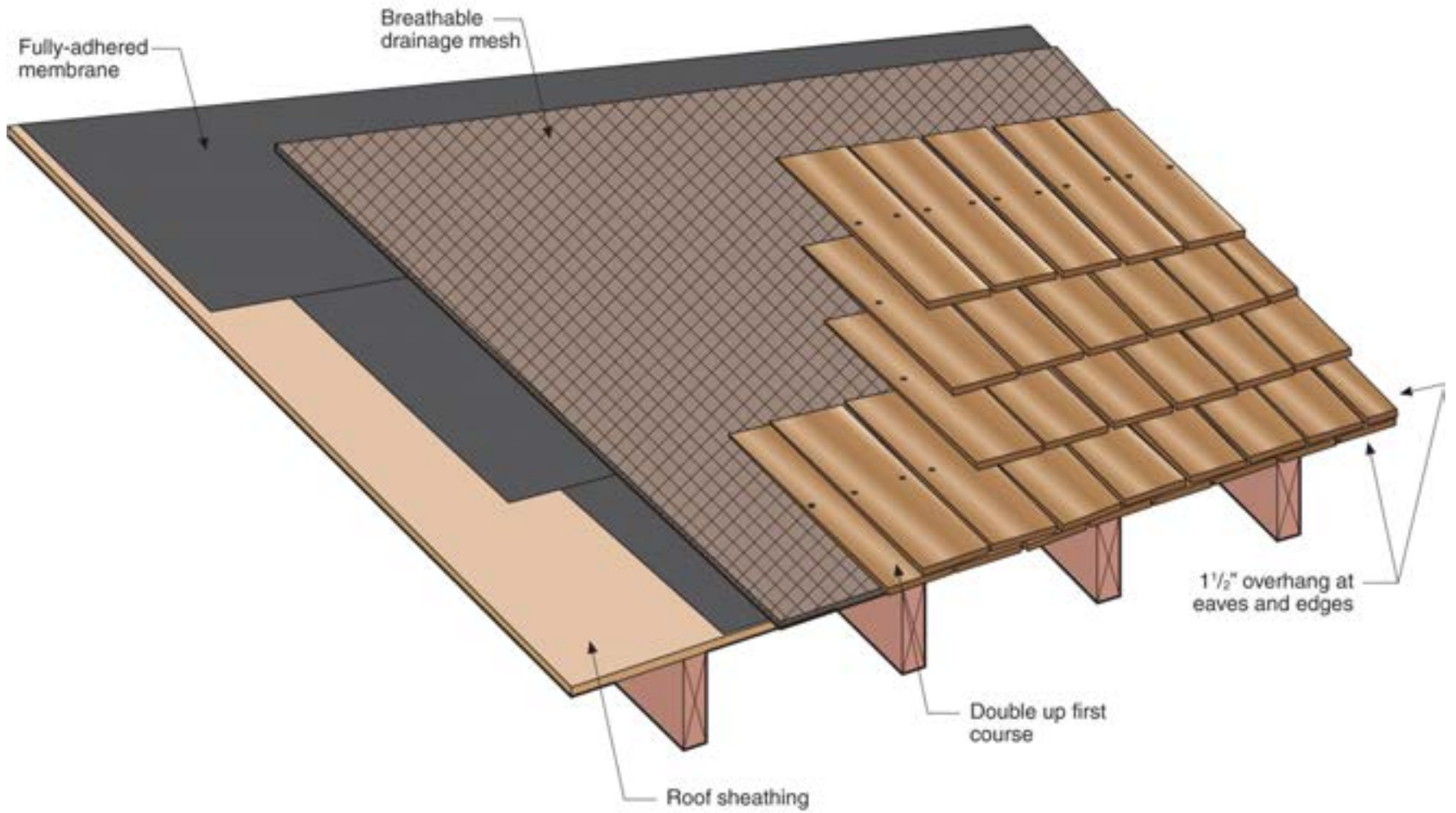

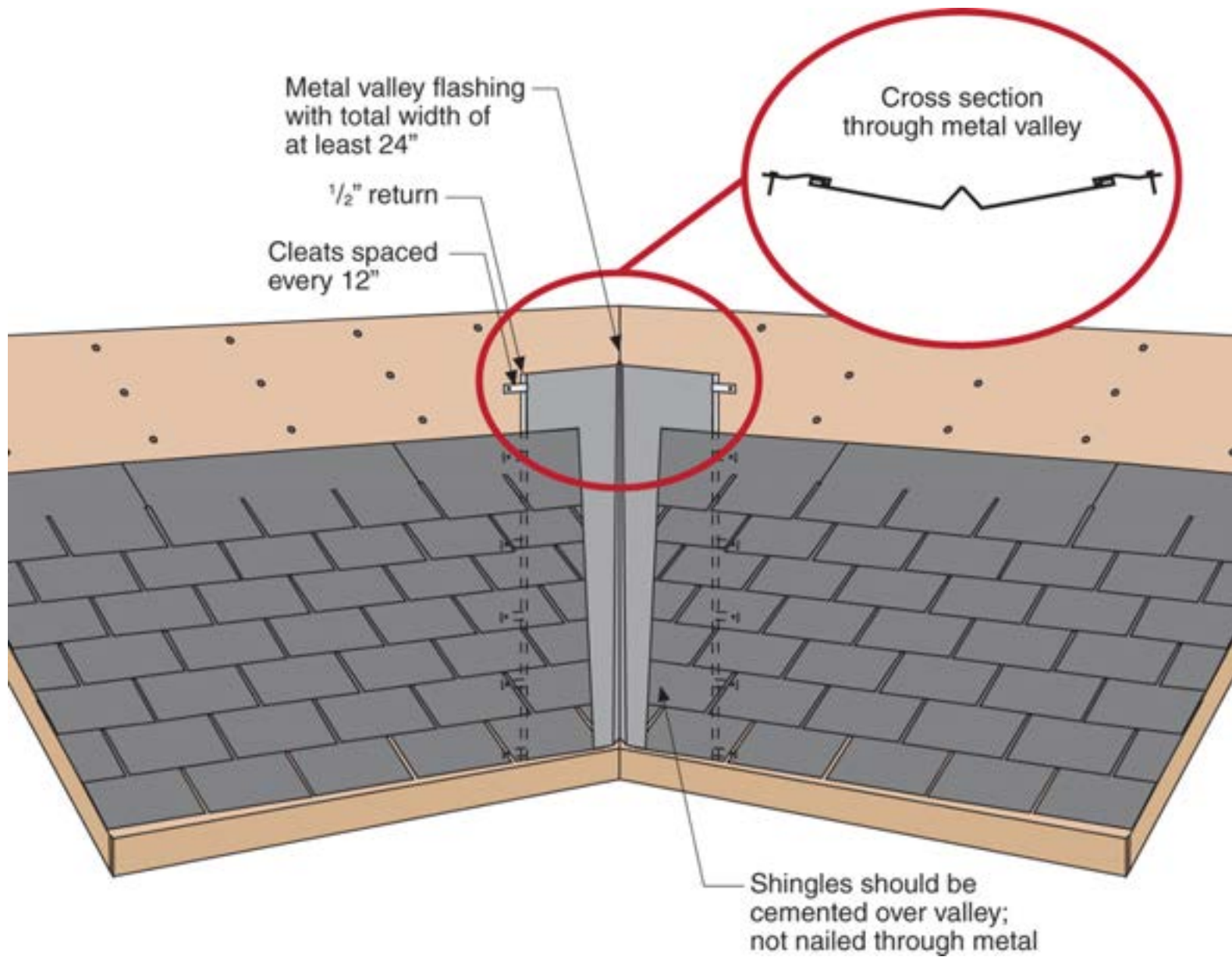

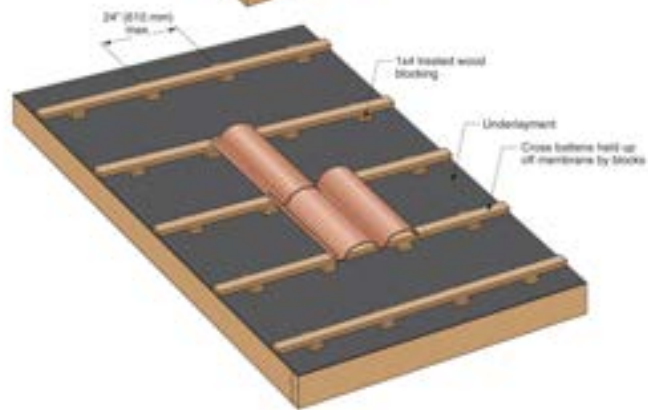
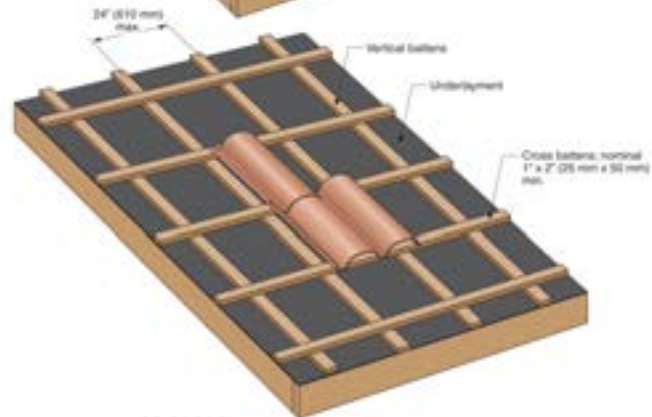
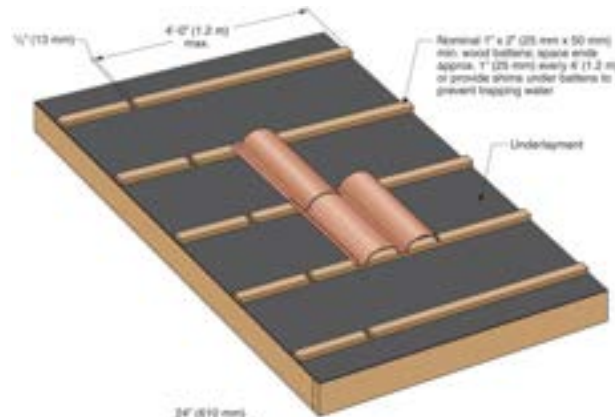







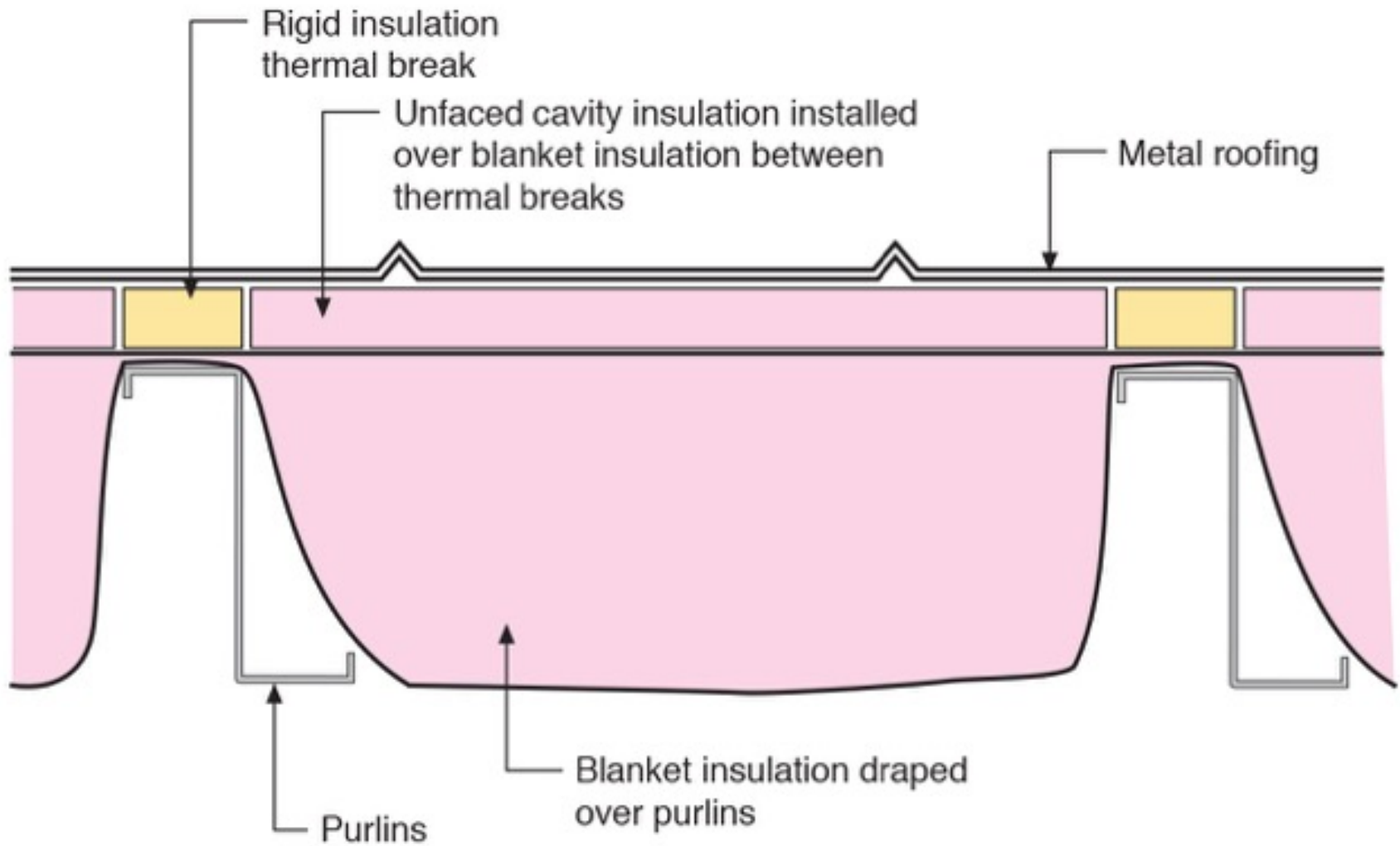

Blanket Insulation Purlin Roof System











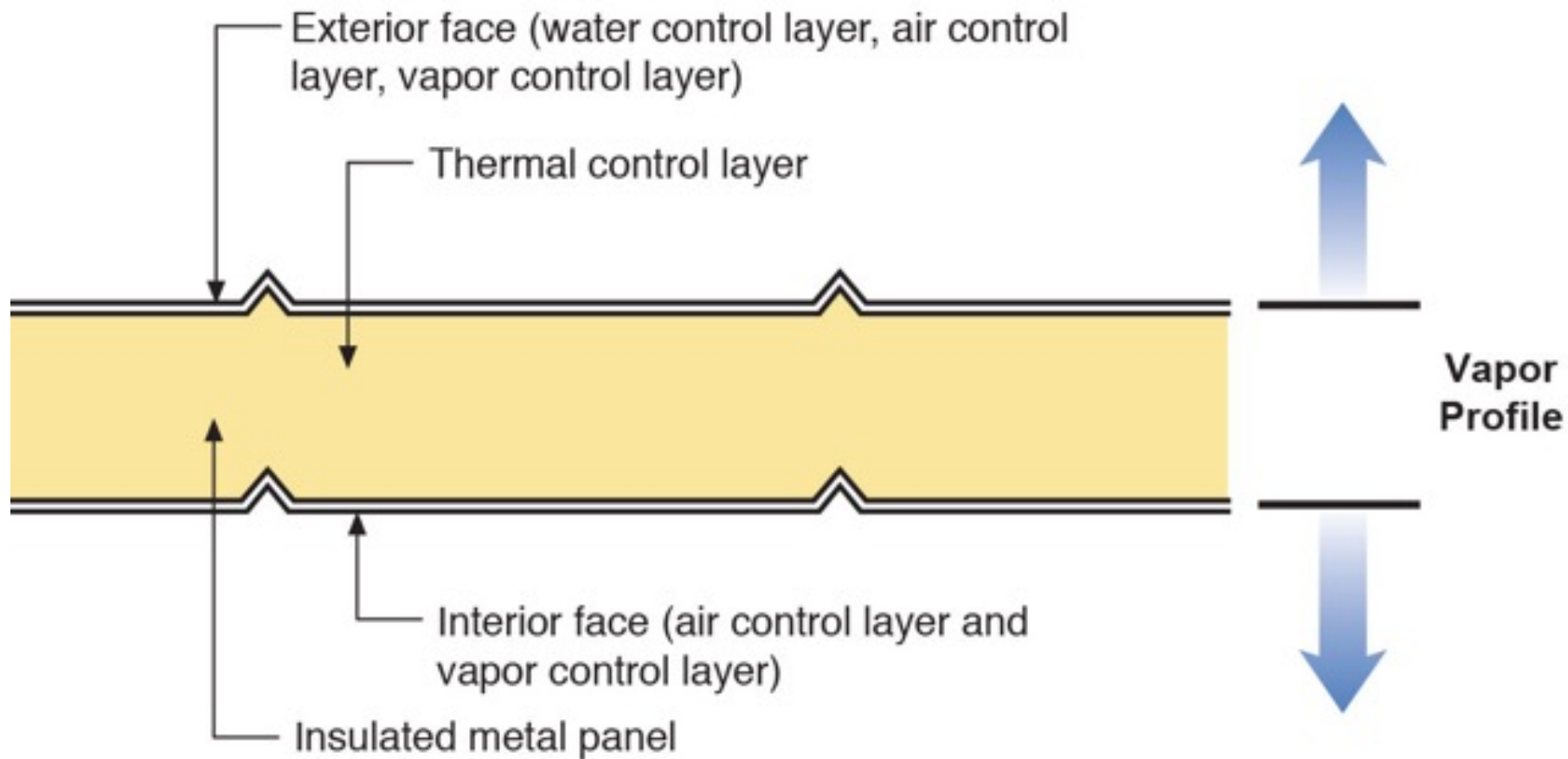

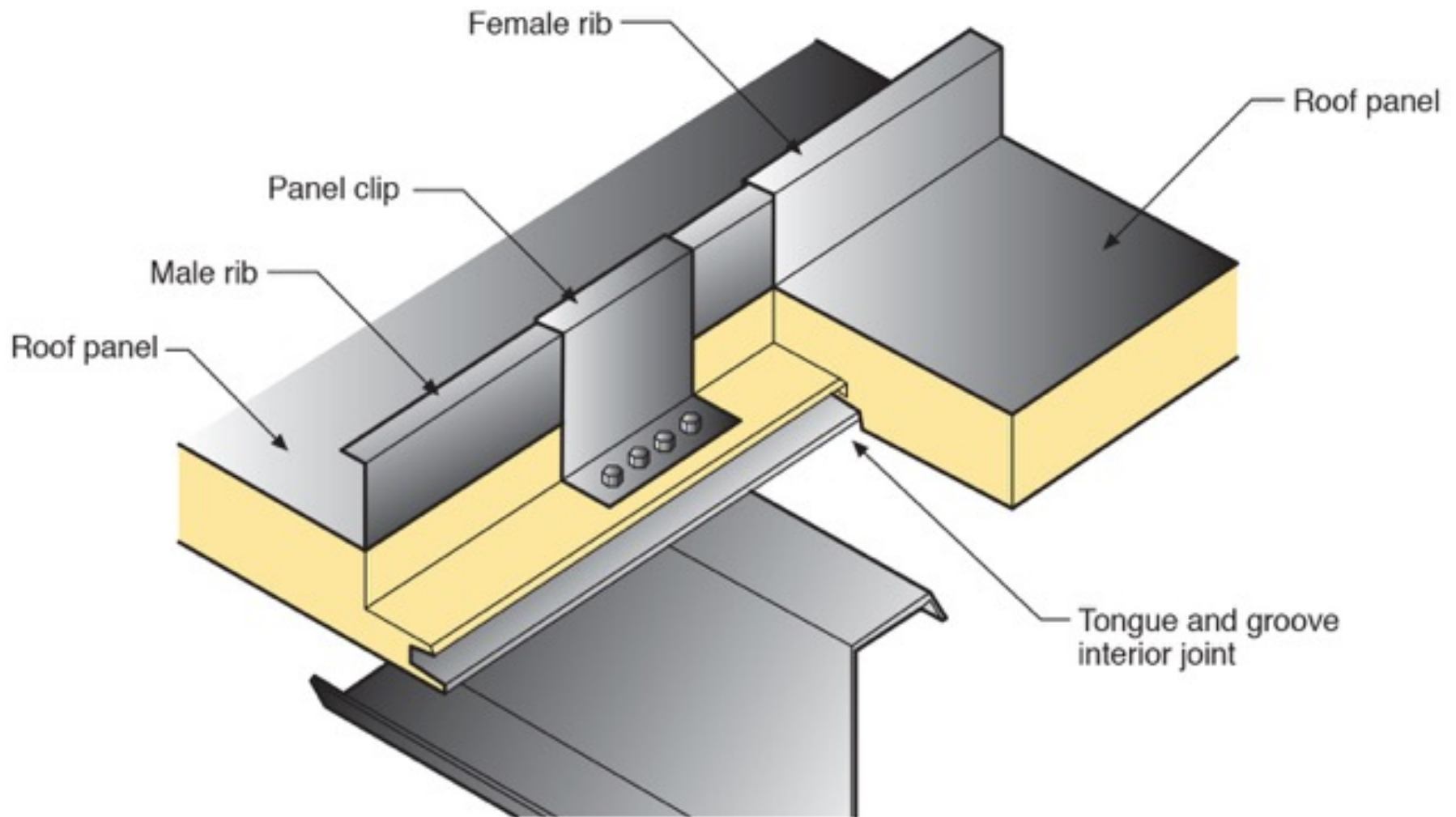



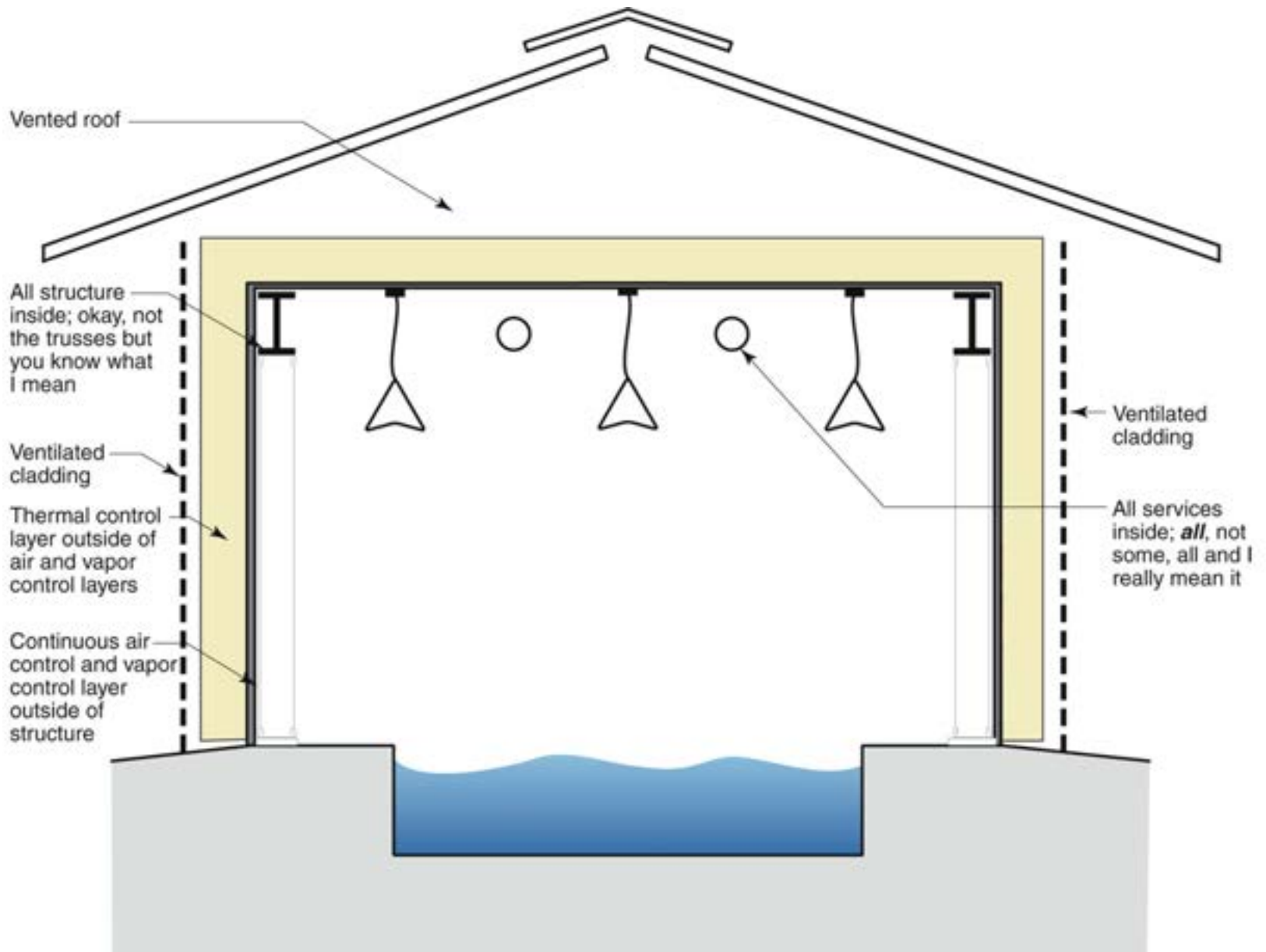

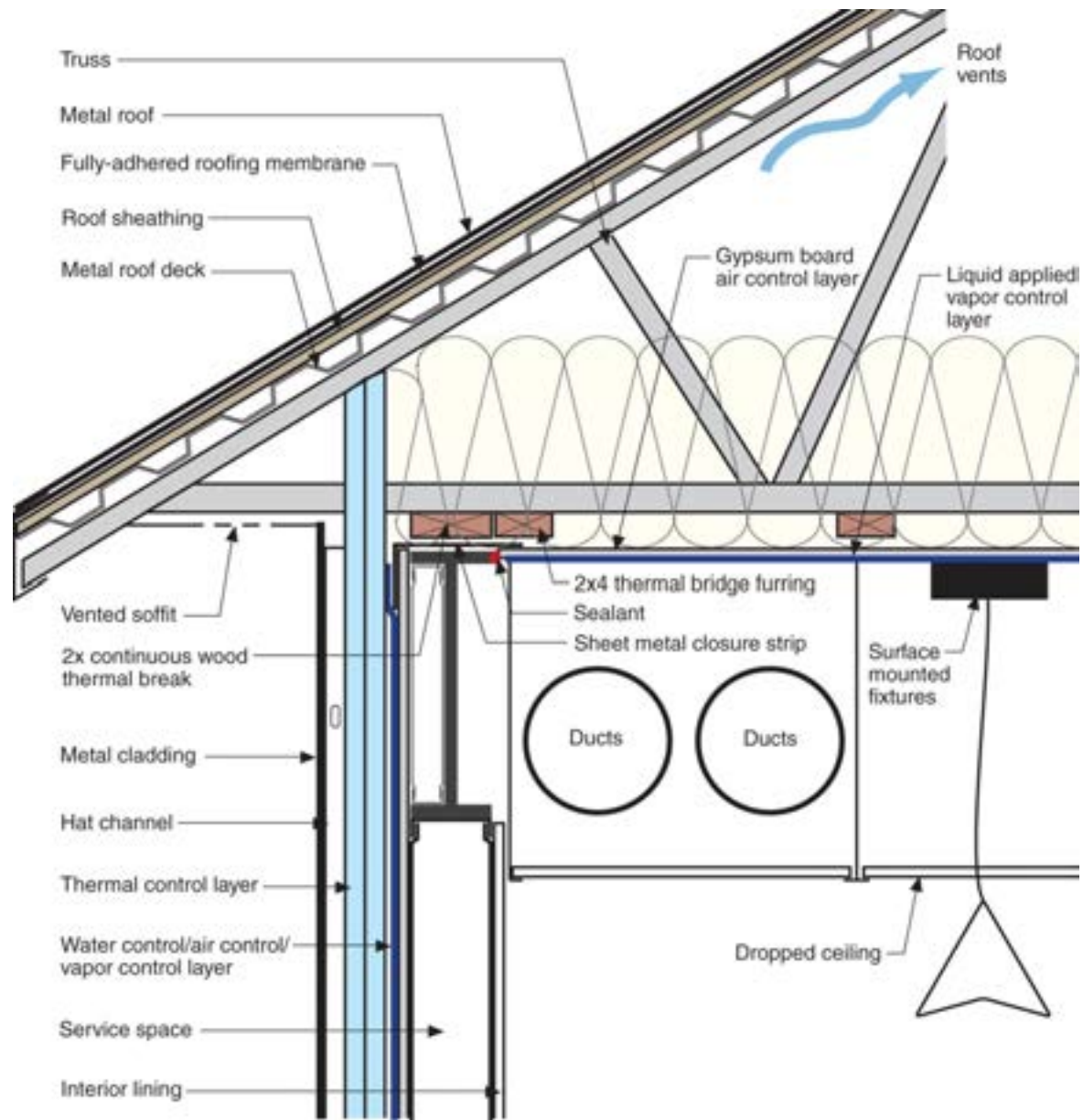

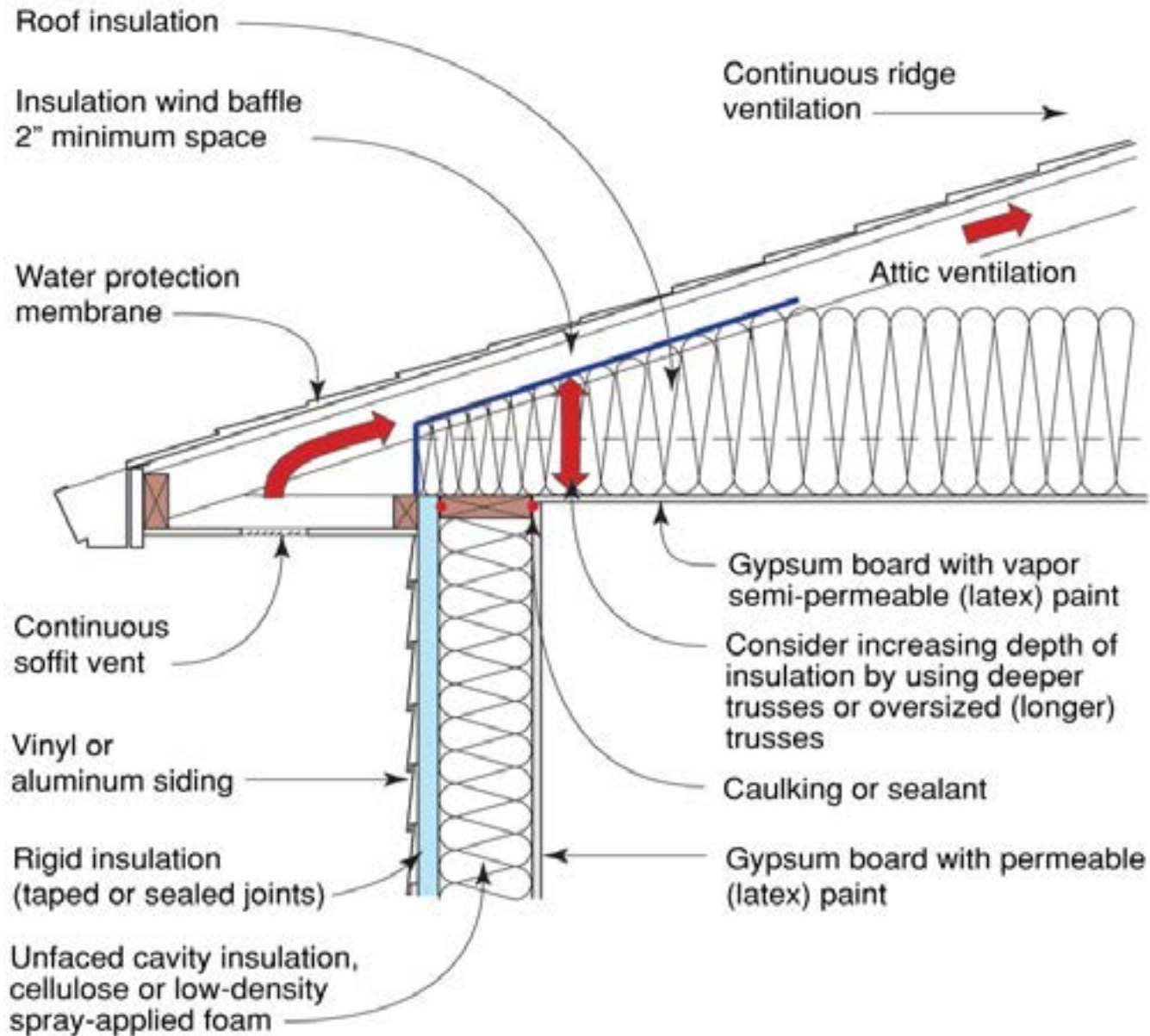



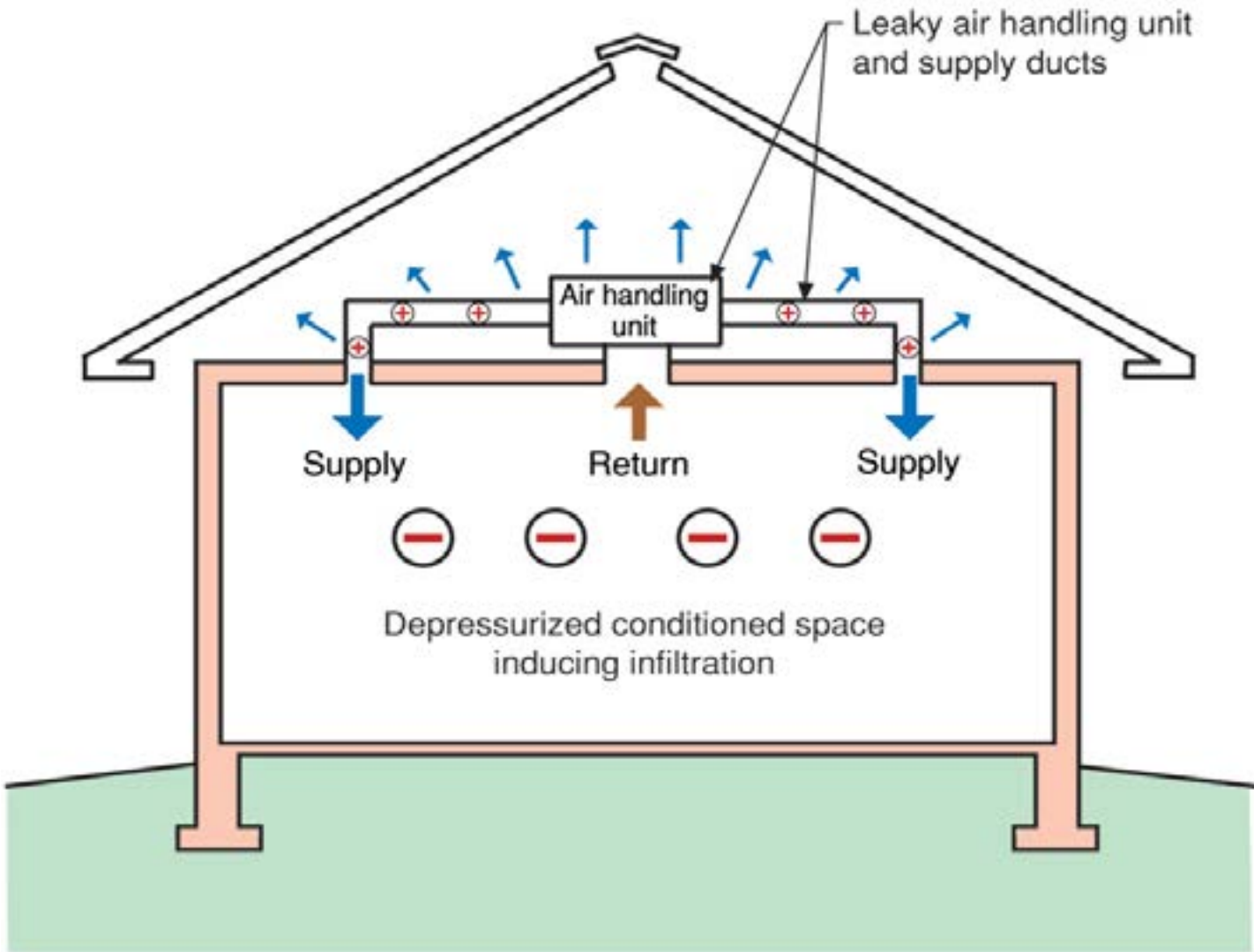

Note: Colored shading depicts the building's thermal barrier and pressure boundary. The thermal barrier and pressure boundary enclose the conditioned space.



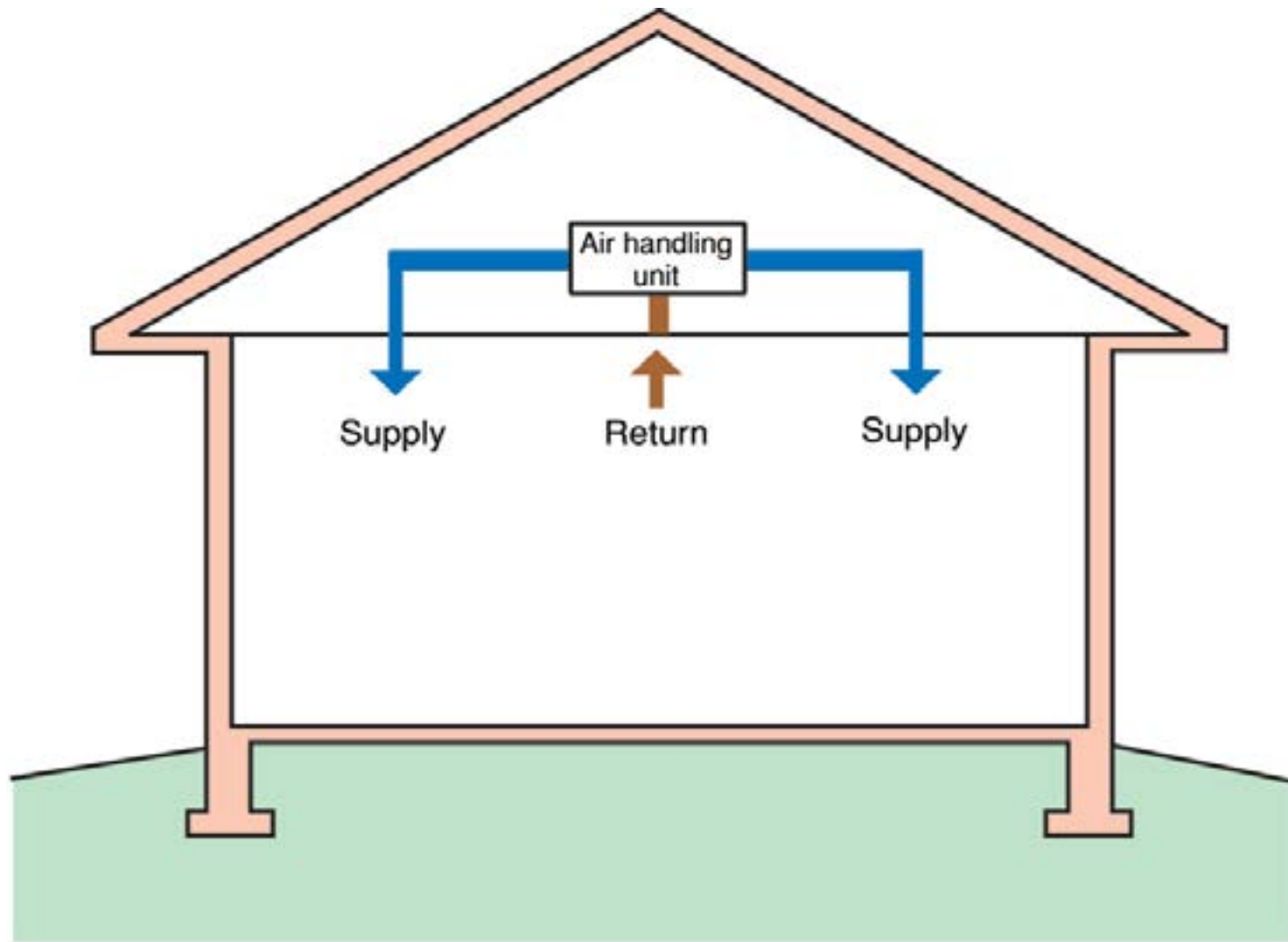

Note: Colored shading depicts the building's thermal barrier and pressure boundary. The thermal barrier and pressure boundary enclose the conditioned space.



